

MERLYN

series



it's all about the experience

THE SERIES COLLECTION | APRIL 2018



65% of consumers who bought a Merlyn shower designed their bathroom around it making the shower the focal point of the bathroom
(source: Dolmen research UK December 2017)



Contents

about.

Welcome to Merlyn Showering	04
The Series Collection	06
Mersfield Stayclear	08
Merlyn Lifetime Guarantee	09
New from Merlyn	10

products.

10 Series	12
8 Series Frameless	26
8 Series	38
6 Series Frameless	52
6 Series	56
Wetrooms	70
SecureSeal Bath Screens	86
Bath Screens	90
TrueStone Trays	96
Level25 Trays	99
MStone Trays	102

technical information.

Product Information	106
---------------------	-----

welcome to Merlyn showering.

We've built our name and reputation on a simple ethos... to deliver on everything we promise to our customers. This is because you are at the heart of everything we do.

We have a relentless desire to deliver the highest level of attention to detail, and our award-winning customer service department - and the wider Merlyn team - live this ethos every single day.

We're passionate about innovation, quality and design, and this is reflected throughout our ranges.

Our unique approach has resulted in us becoming the No.1 shower enclosure brand in the UK and Ireland, with 5 million people enjoying a Merlyn shower experience every day.

When you choose a Merlyn shower you are investing in one of the world's most luxurious showering environments and you get the added peace of mind of our Lifetime Guarantee.

Thank you for choosing Merlyn.

The Merlyn Team

Award Winning Customer Service

Contact us on our UK Freephone Number 0808 1011429 where we have an award winning dedicated team of specialists who are on hand to give you a personalised solution to your query.

passion to be precise.

Behind the exceptional products Merlyn produce, is a team of world class design innovators.

For us, it's all about providing the ultimate showering experience - from the smooth running of our shower doors, to the beautiful lines of our design and the quality of our fittings. We are proud to say that our unique approach has resulted in us being the UK and Ireland's No.1 showering company for enclosures and trays.



the series collection

It's all about the experience

Made up of shower enclosures, trays and bathscreens, the Merlyn Series Collection is all about providing the ultimate showering experience - from the smooth running of the shower doors to the beautiful and elegant design and the quality of fittings.

Even the smallest of details have been considered, meaning the Series Collection meets the highest demands in terms of design, quality and performance.

The flagship 10 Series is a standout in terms of exquisite design. It is a luxurious range that allows you to add your own personal touch.

The elegant 8 Series allows you to make a real style statement in your bathroom and the 6 Series gives homeowners a beautiful, affordable choice of enclosure.

We hope you enjoy experiencing our collection as much as we have enjoyed designing it.



choose the door

to match your space...

10 | series

Stands alone in terms of exquisite design

- 2100mm high
- 10mm glass
- Smoked Black Glass / Bespoke
- Lifetime Guarantee and Mershield Stayclear Coating

See page 12

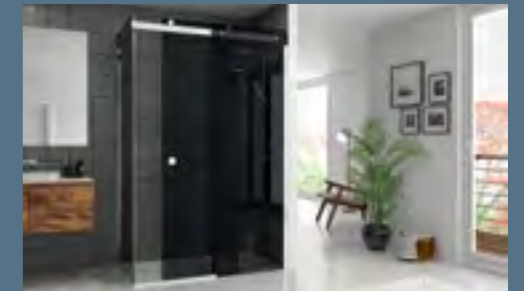

8 | series | *frameless*

An experience that's elegantly minimalist

- 2000mm high
- 8mm glass
- Frameless
- Lifetime Guarantee and Mershield Stayclear Coating

See page 26

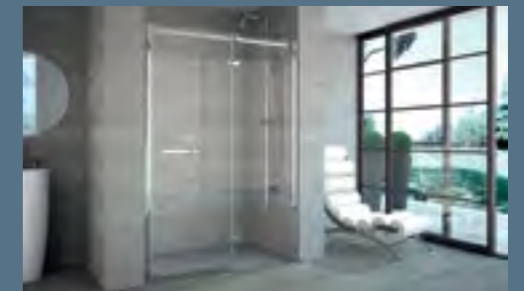

8 | series

Gives your bathroom style and functionality

- 1950mm high
- 8mm glass
- Lifetime Guarantee and Mershield Stayclear Coating

See page 38

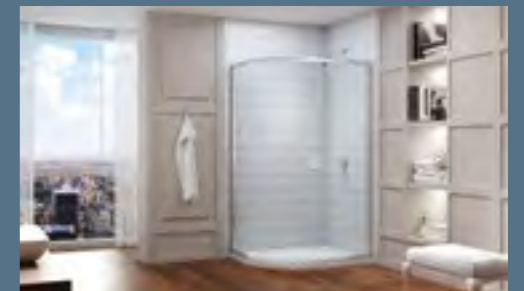

6 | series | *frameless*

Gives a beautiful look with exceptional value

- 2000mm high
- 8mm and 6mm glass
- Frameless
- Lifetime Guarantee and Mershield Stayclear Coating

See page 52



6 | series

6 Series gives homeowners affordable quality

- 1900mm high
- 6mm glass
- Lifetime Guarantee and Mershield Stayclear Coating

See page 56





Without Mershield Stayclear

With Mershield Stayclear



Natural glass surface.



Mershield Stayclear coating creates a smooth layer over the surface of natural glass, lowering surface friction, making it easier for water, soap and lime deposits to run off the glass.



MERSHIELD
STAYCLEAR

Mershield *stayclear*

Merlyn Showering treats every product in the Series Collection with a special protective coating to ensure the glass maintains its sparkle. This comes as standard as part of our on-going commitment to service.

Mershield Stayclear acts as a protective coating which when applied to glass, helps the glass to remain shiny and new without the need for tiresome cleaning. When cleaned correctly it helps prevent the build up of limescale and soap deposits making the shower glass "easy to clean". Please see tips for keeping the glass in pristine condition.

Without Mershield Stayclear Protective Coating

Without Mershield Stayclear protection, water and soap deposits cling to the glass surface causing a build up of grime, requiring more vigorous cleaning.

With Mershield Stayclear Protective Coating

The Mershield Stayclear coating provides a larger contact angle for the water droplets on the surface and makes the drops smaller than drops falling on an untreated surface. This ensures the droplets roll away much faster down the surface, minimising deposits left behind.

Tips on how to keep your Merlyn glass in pristine condition:

- It is important to clean your glass after every use - wipe down with a soft cloth.
- Install the enclosure in a well ventilated area.
- Do not allow limescale to build up in hard water areas.
- Ensure that any residual water on the glass is removed after every use.
- Clean the glass regularly using soapy water.
- DO NOT use abrasive products on any surfaces.

Merlyn *lifetime guarantee*



Merlyn is committed to developing products that meet the highest demands in terms of design, performance and quality.

Due to our extreme confidence in our products and our unrelenting desire to deliver only the highest level of service, we have created the Merlyn Lifetime Guarantee.

Merlyn shower enclosures are crafted and engineered for a lifetime.

For more about our Merlyn Lifetime Guarantee, contact our Merlyn customer service team on 0808 101 1429.

Register your Merlyn product:

To register your new Merlyn product for the Lifetime Guarantee, log on to www.merlynshowering.com and fill in your information.



www.merlynshowering.com

NEW
from Merlyn



8 Series Curved Showerwall



Merlyn Black Showerwall



Showerwall / With Vertical Post

NEW
from Merlyn

8 Series Curved Showerwall

The beautiful curved glass of the new 8 Series Curved Showerwall follows the contour of your offset quadrant tray, giving a softer finish to your bathroom design. The extra length of the curved panel also deflects water spray inwards. This frameless design boasts the Mershield Stayclear, ensuring easy clean glass, and peace of mind with the Merlyn Lifetime Guarantee.



Level25 Quadrant Tray

Added to our tray options this year is the NEW Level25 Quadrant Tray. Available in standard quadrant and offset this tray offers you greater choice from our Level25 Tray range.

COMING SOON

Merlyn Black

Merlyn Black offers you a striking option to complement and contrast your bathroom space. The 8mm glass with a minimalist and sleek matt black profile offers you 3 enclosure choices - a Slider, a Hinge & Inline and a Showerwall option. Each option offers stunning frameless design, adding a touch of class and contrast to any bathroom.



10|series

This range is the flagship of the Merlyn Series Collection, it exudes the very finest in style, luxury and quality. These beautifully designed solid doors can be personalised to suit any space and design requirements.

Why choose 10 Series?



10mm glass

Adding to the quality feel of this range, 10 Series products are manufactured using up to 10mm toughened safety glass.

Towering glass height

With up to an impressive 2100mm glass height, 10 Series gives you an amazing sense of space when showering.

A choice of handles

The 10 Series range gives you a choice of handles to suit your own personal style with both a chrome circular handle and an eyelet handle as standard with your enclosure.



Tested for quality & safety

All products are rigorously tested by us and by global health and safety experts to make sure they adhere to the highest quality standards (CE mark info page 109).



Quiet glide wheels

Using Merlyn's years of engineering experience, the 10 Series also features a quiet glide wheel which softly opens and closes with minimum effort.



10^{MM}
GLASS
THICKNESS

LIFETIME
GUARANTEE

MERSHIELD
STAYCLEAR

Sliding Door

This spectacular enclosure makes a definite style statement. Contemporary style lovers will delight in the optional Smoked Black glass and its roller action. While minimalist in appearance this sliding door has an impressive 10mm toughened glass, making it the flagship of the Merlyn Series Collection range.

features.

- Height 2100mm
- Eyelet handle with chrome eyelet option and circular filler plate option
- Smoked Black glass option
- Extra smooth roller action for quiet closing
- Door handed - order Left Hand (L) or Right Hand (R)
- Wetroom compatible
- Bespoke options available, see page 24

Sliding Door						Add a Merlyn MStone Tray		
Size	Tray Finish Adjustment	Glass Type	Order Code	Price £ Exc. VAT	Price £ Inc. VAT	Order Code*	Price £ Exc. VAT	Price £ Inc. VAT
1000	950-985	Clear	M108231C Lor R	1318.47	1582.16	MS108231C Lor R	1514.93	1817.92
1100	1050-1085	Clear	M108251C Lor R	1318.47	1582.16	MS108251C Lor R	1538.70	1846.44
1200	1150-1185	Clear	M108241C Lor R	1318.47	1582.16	MS108241C Lor R	1524.92	1829.91
1200	1150-1185	Smoked Black	M108241B Lor R	1552.96	1863.55	MS108241B Lor R	1759.41	2111.30
1400	1350-1385	Clear	M108291C Lor R	1375.78	1650.94	MS108291C Lor R	1685.79	2022.94
1400	1350-1385	Smoked Black	M108291B Lor R	1612.60	1935.12	MS108291B Lor R	1922.60	2307.12
1600	1550-1585	Clear	M108271C Lor R	1528.67	1834.40	MS108271C Lor R	1944.54	2333.45
1700	1650-1685	Clear	M1081700CH Lor R	1559.57	1871.48	MS1081700CH Lor R	2055.82	2466.98

*Order code for ordering shower enclosure with tray. This product is handed please choose L for left and R for right when ordering. Please add 15mm to Tray Finish Adjustment when using a Side Panel.

Optional Side Panel					
Size	Tray Finish Adjustment	Glass Type	Order Code	Price £ Exc. VAT	Price £ Inc. VAT
760	730-750	Clear	M102210C	598.74	718.49
800	770-790	Clear	M102211C	598.74	718.49
800	770-790	Smoked Black	M102211B	791.93	950.31
900	870-890	Clear	M102221C	598.74	718.49
900	870-890	Smoked Black	M102221B	830.32	996.38

Please Note: Moving panel door must close onto the side panel. For wetroom installation, please reduce Side Panel Tray Finish Adjustment by 20mm.

Sliding Door in a Recess / Shown as Right Hand (R)

Sliding Door with Side Panel

technical drawing.



A: Opening size can be adjusted to your requirements
B: Fixed Panel

A total of 35mm adjustment (max of 12mm adjustment in wall profile on closing side for out of true walls i.e. on right hand side of image shown).

Size	A Min-Max	B
1000	405-300	510
1100	455-350	560
1200	505-400	610
1400	605-500	710
1600	605-500	910
1700	605-500	1010

glass options.

- Clear
- Smoked Black



1 Door Offset Quadrant / Shown as Right Hand (R)

1 Door Offset Quadrant

Our 1 Door Offset Quadrant has almost celebrity status. Constructed from up to 10mm toughened glass with the option of smoked Black glass, this stunning enclosure offers strength and practicality which belies its beauty.

features.

- Height 2000mm
- Up to 10mm toughened glass
- Eyelet handle with chrome eyelet option and circular filler plate option
- Smoked Black glass option
- Extra smooth roller action for quiet closing
- Door handed - order Left Hand (L) or Right Hand (R)
- Wetroom compatible

1 Door Offset Quadrant						Add a Merlyn MStone Tray		
Size	Tray Finish Adjustment	Glass Type	Order Code	Price £ Exc.VAT	Price £ Inc. VAT	Order Code*	Price £ Exc. VAT	Price £ Inc. VAT
1000x800	975-995 775-795	Clear	M103233C Lor R	1655.37	1986.44	MS103233C Lor R	1879.36	2255.23
1200x800	1175-1195 775-795	Clear	M103243C Lor R	1840.75	2208.90	MS103243C Lor R	2075.99	2491.18
1200x900	1175-1195 875-895	Clear	M103241C Lor R	1840.75	2208.90	MS103241C Lor R	2088.51	2506.21
1200x900	1175-1195 875-895	Smoked Black	M103241B Lor R	1999.87	2399.84	MS103241B Lor R	2247.63	2697.16
1400x800	1375-1395 775-795	Clear	M10148H Lor R	1967.58	2361.10	M10148HB Lor R	2242.69	2691.23

*Order code for ordering shower enclosure with tray. This product is handed please choose L for left and R for right when ordering.

Merlyn Dedicated Offset Quadrant Tray (1400x800)			
Size	Order Code	Price £ Exc. VAT	Price £ Inc. VAT
1400x800	S148Q Lor R	275.11	330.13

Please Note: The 1400mmx800mm tray is not an MStone Tray, it is a dedicated single skinned tray. For wetroom installation, please reduce Side Panel Tray Finish Adjustment by 20mm.

technical drawing.

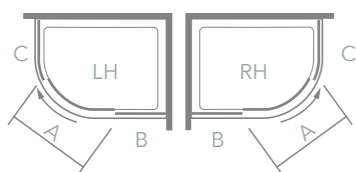

A: Opening size can be adjusted to your requirements
 B: Straight Panel
 C: Curved Panel

All sizes suit 550mm radius tray.
 Note: Curved Panels 8mm glass.
 Extension profiles available. See Page 107.

Size	A Min-Max	B	C
1000x800	435-340	435	520
1200x800	435-340	635	520
1200x900	485-390	635	570
1400x800	435-340	835	520

glass options.

- Clear
- Smoked Black



1 Door Quadrant / Shown as Left Hand (L)

technical drawing.

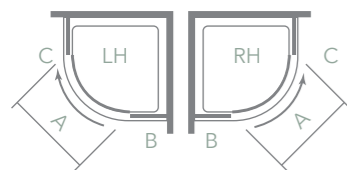

A: Opening size can be adjusted to your requirements
 B: Fixed Panel
 C: Curved Panel

All sizes suit 550mm radius tray.
 Note: Curved Panels 8mm glass.
 Extension profiles available. See Page 107.

Size	A Min-Max	B	C
800	435-340	235	535
900	485-390	340	575

glass options.

- Clear
- Smoked Black

1 Door Quadrant

Beautifully curved glass combined with an exceptionally smooth roller action, which our designers have perfected through years of experience, makes this quadrant door best in its class!

features.

- Height 2000mm
- Up to 10mm toughened glass
- Eyelet handle with chrome eyelet option and circular filler plate option
- Smoked black glass option
- Extra smooth roller action for quiet closing
- Door handed-order Left Hand (L) or Right Hand (R)
- Wetroom compatible

1 Door Quadrant						Add a Merlyn MStone Tray		
Size	Tray Finish Adjustment	Glass Type	Order Code	Price £ Exc.VAT	Price £ Inc. VAT	Order Code*	Price £ Exc.VAT	Price £ Inc. VAT
800	775-795	Clear	M103211C Lor R	1628.15	1953.78	MS103211C Lor R	1787.07	2144.48
900	875-895	Clear	M103221C Lor R	1597.64	1917.17	MS103221C Lor R	1771.59	2125.91
900	875-895	Smoked Black	M103221B Lor R	1836.86	2204.23	MS103221B Lor R	2010.81	2412.97

*Order code for ordering shower enclosure with tray.
 For wetroom installation, please reduce Side Panel Tray Finish Adjustment by 10mm.



10^{MM}
GLASS
THICKNESS

LIFETIME
GUARANTEE

MERSHIELD
STAYCLEAR

Pivot Door

The 10 Series Pivot Door is bound to impress in any bathroom. Its substantial 10mm toughened glass and solid chrome angular double handle provide a style statement that befits the beauty of this door.

features.

- Height 2030mm
- Solid chrome handle
- Fully concealed fixings
- Reversible
- Wetroom compatible

Pivot Door in a recess						Add a Merlyn MStone Tray		
Size	Tray Finish Adjustment	Glass Type	Order Code	Price £ Exc. VAT	Price £ Inc. VAT	Order Code*	Price £ Exc. VAT	Price £ Inc. VAT
800	760-790	Clear	M101211C	1127.44	1352.92	MS101211C	1251.32	1501.58
900	860-890	Clear	M101221C	1136.31	1363.57	MS101221C	1310.25	1572.30
1000	960-990	Clear	M101231C	1194.58	1433.49	MS101231C	1391.03	1669.24

*Order code for ordering shower enclosure with tray.
Please reduce Tray Finish Adjustment by 10mm when using a Side Panel.

Optional Side Panel					
Size	Tray Finish Adjustment	Glass Type	Order Code	Price £ Exc. VAT	Price £ Inc. VAT
800	770-790	Clear	M10P2211C	560.35	672.42
900	870-890	Clear	M10P2221C	585.54	702.65
1200	1170-1190	Clear	M10P2241C	718.73	862.48

Please Note: Moving panel door must close onto the Side Panel.
For wetroom installation, please reduce Side Panel Tray Finish Adjustment by 30mm.

Pivot Door in a Recess

Pivot Door with Side Panel

technical drawing.



A: Door Opening
B: Door Swing

Size	A Min-Max	B
800	560	580
900	660	680
1000	760	780

Note: 10mm adjustment only on closing side.
Extension profiles available. See Page 107.



Pivot Door & Inline Panel / Shown with as Right Hand (R)

technical drawing.

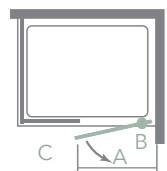

A: Door Opening
B: Door Swing
C: Inline Panel

Size	A Min-Max	B	C
1200	560	580	410
1400	560	580	610
1500	660	680	810
1600	560	580	810
1700	660	680	810
1800	760	780	810

Extension profiles available. See Page 107.

Pivot Door & Inline Panel

Merlyn's 10 Series Pivot Door & Inline Panel is a luxurious showering choice with solid chrome double handles and 10mm toughened safety glass. Flexible size options available from 1200mm to 1800mm.

features.

- Height 2030mm
- Solid chrome handle
- Fully concealed fixing
- Reversible
- Wetroom compatible

Pivot Door and Inline Panel (Glass Type: Clear)							Add a Merlyn MStone Tray		
Size	Tray Finish Adjustment	Size of Pivot Door Supplied	Size of Pivot Inline Panel Supplied	Order Code	Price £ Exc.VAT	Price £ Inc.VAT	Order Code*	Price £ Exc. VAT	Price £ Inc. VAT
1200	1150-1190	800	400	M101241C	1553.08	1863.70	MS101241C	1759.53	2111.44
1400	1350-1390	800	600	M101291C	1618.06	1941.67	MS101291C	1928.06	2313.67
1500	1450-1490	900	600	M101261C	1637.94	1965.53	MS101261C	1991.32	2389.59
1600	1550-1590	800	800	M101271C	1720.30	2064.36	MS101271C	2136.17	2563.40
1700	1650-1690	900	800	M101281C	1729.16	2074.99	MS101281C	2148.86	2578.64
1800	1750-1790	1000	800	M101218C	1787.38	2144.86	-	-	-

*Order code for ordering shower enclosure with tray.

Optional Pivot Door and Inline Panel Side Panel					
Size	Tray Finish Adjustment	Glass Type	Order Code	Price £ Exc.VAT	Price £ Inc.VAT
800	770-790	Clear	M10PI2211C	555.55	666.66
900	870-890	Clear	M10PI2221C	598.74	718.49

For wetroom installation, please reduce Side Panel Tray Finish Adjustment by 10mm. Please Note: Moving panel door must close onto the Inline Panel.



10^{MM}
GLASS
THICKNESS

LIFETIME
GUARANTEE

MERSHIELD
STAYCLEAR

Bespoke sliding door and side panel with increased height / Shown as Left Hand (L)

Bespoke - Sliding Door

Create the perfect Sliding Door to suit your space. Merlyn offer bespoke sizes for the 10 Series Sliding Door and Side Panels. With extra heights, widths and glass colour options to choose from, it's time to make your Merlyn shower truly unique to you.

For a detailed quote please contact Merlyn directly on 0808 101 1429.

Glazing Options

There are 4 glass options to choose from: Standard Clear, Smoked Black, Satin and Opti-White. Please note these are additionally priced options.

Ordering Bespoke Products

To order a bespoke product please supply a drawing with accurate measurements to Merlyn at sales@merlyn.ie or call the customer service team directly on 0808 101 1429. Please contact Merlyn for additional delivery charges on side panel sizes over 1200mm and further terms and conditions.

Bespoke Heights.

Max height available is 2200mm with minimum height of 1900mm.

Bespoke Widths.

Max width available on Sliding Door and Fixed Panel is 2000mm. Side Panels can be created from 300mm wide up to max width of 2200mm.

Glass Options.

-  Standard
-  Smoked Black
-  Satin
-  Opti-White

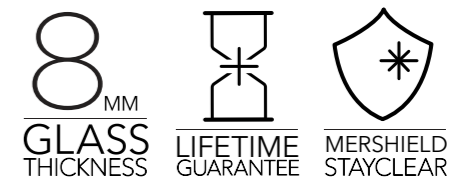

8 | series | *frameless*

If your bathroom is crying out for an enclosure that has a minimalist designer frame the 8 Series Frameless range is perfect. With its chrome hinges and handles, it's the perfect complement for any modern styled bathroom.

Why choose 8 Series frameless?

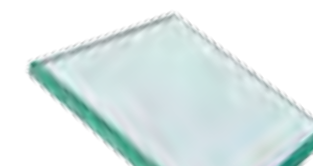

8mm glass

The 8 Series Frameless range features stunning 8mm frameless glass, standing at the impressive height of 2000mm.

Merlyn signature badging

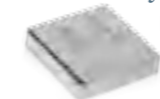

For the designer look, the minimalist frame is complemented with subtle Merlyn embossing. A true mark of quality for you to showcase in your bathroom.

Horizontal designer handle



The Hinged and Quadrant shapes in this range feature our exclusive horizontal handle which offers the perfect symmetry and solid feel to this truly stunning range.



Tested for quality & safety

All products are rigorously tested by us and by global health and safety experts to make sure they adhere to the highest quality standards (CE mark info page 109).

Ultra slim hinges

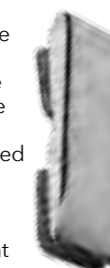

Complementing the designer minimalist look, the ultra sleek one piece hinges on our 8 Series Frameless range are our most innovative to date. The internal mechanics are concealed fully in one elegant chrome plate, which gives you a secure showering environment with added style.



Sliding Door / Shown with Side Panel as Right Hand (R)

technical drawing.

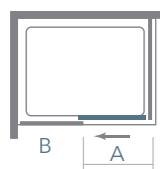

A: Door Opening
B: Fixed Panel

Size	A	B
1200	450	565
1400	550	665

Extension profiles available. See Page 107.

Sliding Door

The 8 Series Frameless Sliding Door has the smoothest rolling action that needs to be seen to be believed. With its sleek minimalist frame and stunning designer features; it will bring a touch of class to any bathroom.

features.

- Height 2000mm
- Concealed fittings
- Mershield Stayclear easy clean protected glass
- Translucent seals
- Reversible
- Wetroom compatible
- Lifetime Guarantee

Sliding Door					Add a Merlyn MStone Tray		
Size	Tray Finish Adjustment	Order Code	Price £ Exc. VAT	Price £ Inc. VAT	Order Code*	Price £ Exc. VAT	Price £ Inc. VAT
1200	1150-1190	A0920DH	867.82	1041.38	AS0920DH	1079.29	1295.14
1400	1350-1390	A0920HH	999.88	1199.86	AS0920HH	1309.88	1571.86

*Order Code for ordering shower enclosure and tray.
Please add 20mm to Tray Finish Adjustment when using a Side Panel.

Optional Side Panel				
Size	Tray Finish Adjustment	Order Code	Price £ Exc. VAT	Price £ Inc. VAT
800	765-790	A0920LH	454.07	544.88
900	865-890	A0920PH	481.65	577.98

For wetroom installation, please reduce Side Panel Tray Finish Adjustment by 20mm.

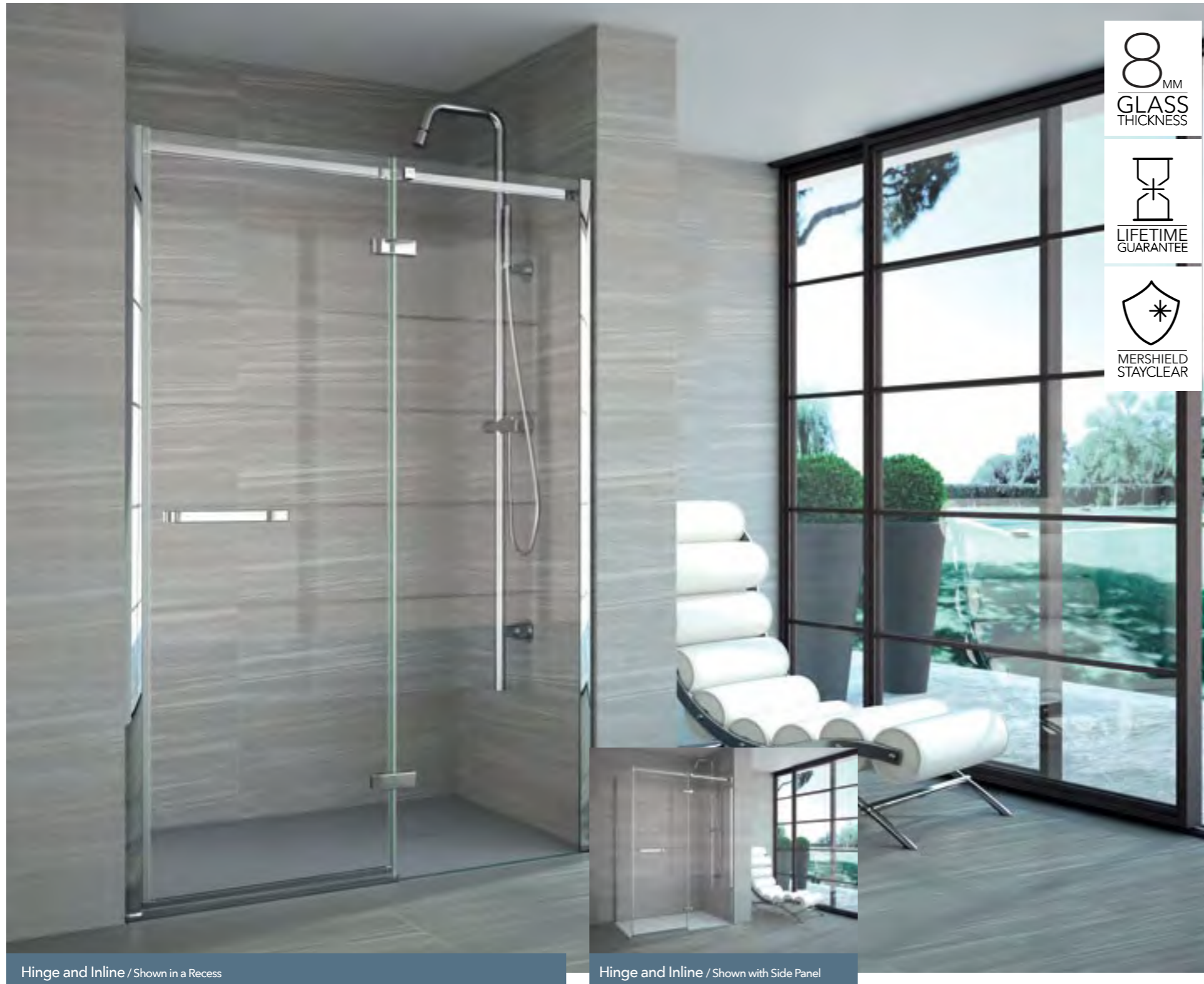

Hinge and Inline / Shown in a Recess

Hinge and Inline / Shown with Side Panel

technical drawing.



A: Door Opening
B: Door Swing
C: Inline Panel

Extension profiles available. See Page 107.

Size	A	B	C	Size	A	B	C
900	560	630	240	1200+	690	755	460
900+	560	630	285	1400	645	710	660
1000	645	710	260	1400+	690	755	660
1000+	690	755	260	1600	645	710	860
1100	645	710	360	1600+	690	755	860
1100+	690	755	360	1700	645	710	960
1200	645	710	460	1700+	690	755	960

Hinge and Inline

A hugely practical yet stylish option, the 8 Series Frameless Hinge & Inline in a Recess is perfect for recesses or en suites. The Hinge and Inline redefines the art of showering with its creative fusion of style and practicality.

features.

- Height 2000mm
- Large horizontal designer handle including internal clutch bar handle
- Secure "Clunk" closing
- Ultra slim hinges
- Concealed fixing
- Reversible
- Wetroom compatible

Hinge and Inline in a Recess					Add a Merlyn MStone Tray		
Size	Tray Finish Adjustment	Order Code	Price £ Exc. VAT	Price £ Inc. VAT	Order Code*	Price £ Exc. VAT	Price £ Inc. VAT
900	860-905	A0611X0	1014.26	1217.11	A0611X0B	1188.20	1425.84
900+	905-950	A0611Y0	1014.26	1217.11			
1000	960-1005	A0611RH	1014.26	1217.11	A0611RHB	1210.72	1452.86
1000+	1005-1050	A0611RF	1014.26	1217.11			
1100	1060-1105	A0611SH	1071.92	1286.30	A0611SHB	1292.15	1550.58
1100+	1105-1150	A0611SF	1071.92	1286.30			
1200	1160-1205	A0611TH	1099.00	1318.80	A0611THB	1305.45	1566.54
1200+	1205-1250	A0611TF	1099.00	1318.80			
1400	1360-1405	A0611UH	1379.67	1655.60	A0611UHB	1689.67	2027.60
1400+	1405-1450	A0611UF	1379.67	1655.60			
1600	1560-1605	A0611VH	1432.75	1719.30	A0611VHB	1848.62	2218.34
1600+	1605-1650	A0611VF	1432.75	1719.30			
1700	1660-1705	A0611WH	1477.52	1773.02	A0611WHB	1973.78	2368.54
1700+	1705-1750	A0611WF	1477.52	1773.02			

Please Note: Only + sizes are to be used with a Side Panel.
*Order Code for ordering shower enclosure with tray.

Hinge and Inline with Side Panel					Add a Merlyn MStone Tray		
Size	Tray Finish Adjustment	Order Code	Price £ Exc. VAT	Price £ Inc. VAT	Order Code*	Price £ Exc. VAT	Price £ Inc. VAT
900+	880-900	A0611Y0	1014.26	1217.11	A0611Y0B	1188.20	1425.84
1000+	980-1000	A0611RF	1014.26	1217.11	A0611RFB	1210.72	1425.84
1100+	1080-1100	A0611SF	1071.92	1286.30	A0611SFB	1292.15	1550.58
1200+	1180-1200	A0611TF	1099.00	1318.80	A0611TFB	1305.45	1566.54
1400+	1380-1400	A0611UF	1379.67	1655.60	A0611UFB	1689.67	2027.60
1600+	1580-1600	A0611VF	1432.75	1719.30	A0611VFB	1848.62	2218.34
1700+	1680-1700	A0611WF	1477.52	1773.02	A0611WFB	1973.78	2368.54

*Order Code for ordering shower enclosure with tray.

Optional Side Panel				
Size	Tray Finish Adjustment	Order Code	Price £ Exc. VAT	Price £ Inc. VAT
760	740-760	A0607B0	453.69	544.43
800	780-800	A0607D0	453.69	544.43
900	880-900	A0607E0	453.69	544.43

Please note: Moving panel door must close onto the Side Panel.
For wetroom installation, please reduce Side Panel Tray Finish Adjustment by 20mm.
Please add 20mm to Tray Finish Adjustment when using a Side Panel.

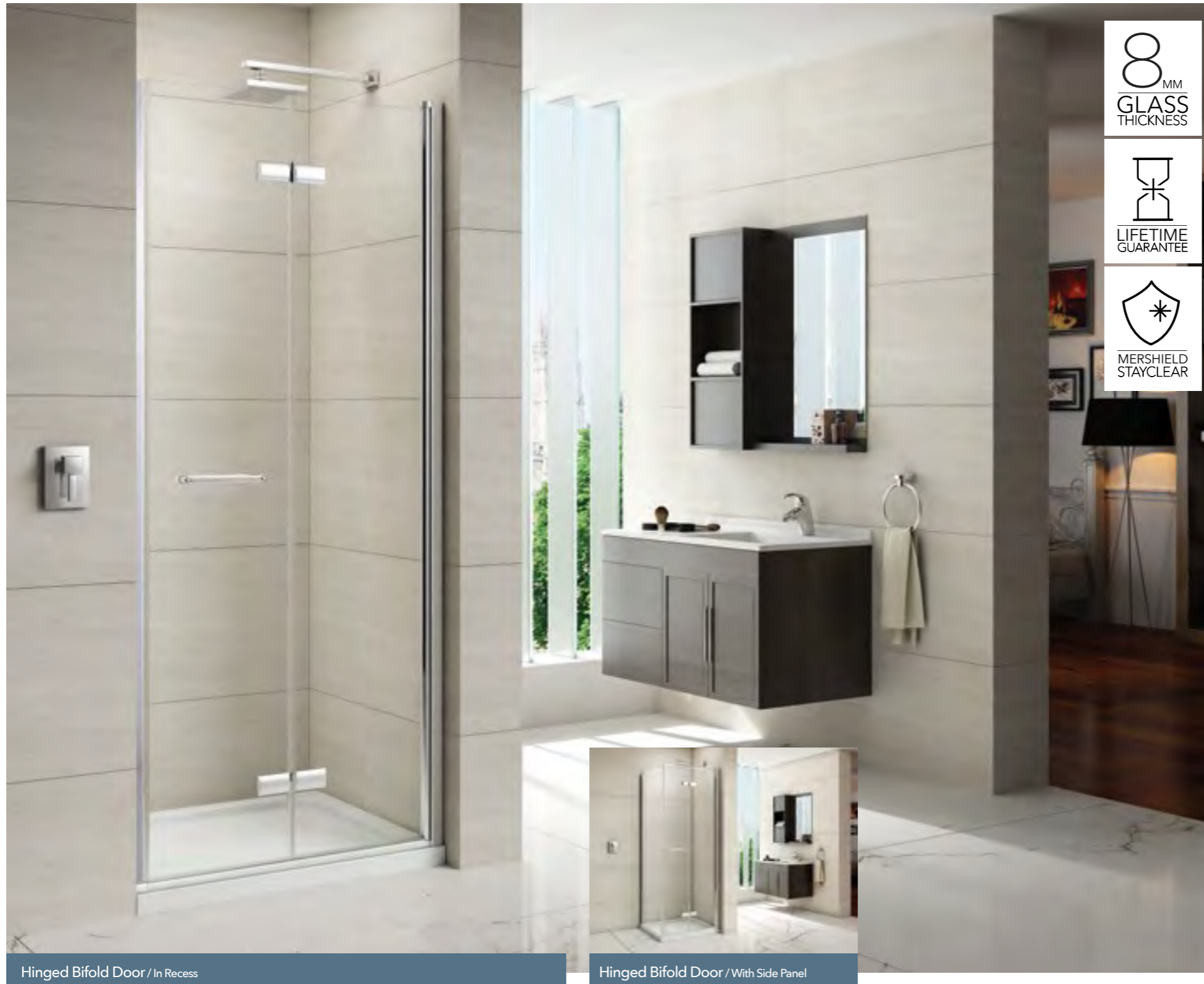

8^{MM}
GLASS
THICKNESS

LIFETIME
GUARANTEE

MERSHIELD
STAYCLEAR

Hinged Bifold Door

The 8 Series Frameless Bifold is an ingenious space saving solution for bathrooms with space restrictions, the hero of the bijou bathroom. Folding away neatly and horizontally flush to the wall, this screen allows you to double your feeling of space in any small bathroom giving you that extra elbow room you desire.

features.

- Height 1950mm
- Frameless
- Reversible
- Space solution
- Minimalist designer hinges

Hinged Bifold Door					Add a Merlyn MStone Tray		
Size	Tray Finish Adjustment	Order Code	Price £ Exc. VAT	Price £ Inc. VAT	Order Code*	Price £ Exc. VAT	Price £ Inc. VAT
760	720-750	M87111	655.41	786.49	M87111B	766.77	920.12
800	760-790	M87211	678.05	813.66	M87211B	801.93	962.32
900	860-890	M87221	722.19	866.63	M87221B	896.14	1075.37
1000	960-990	M87231	745.97	895.16	M87231B	942.42	1130.90

*Order Code for ordering shower enclosure and tray.
Please reduce the Tray Finish Adjustment by 5mm when using a Side Panel.

Optional Side Panel				
Size	Tray Finish Adjustment	Order Code	Price £ Exc. VAT	Price £ Inc. VAT
760	715-735	M82101	432.41	518.89
800	755-775	M82102	432.41	518.89
900	855-875	M82103	458.45	550.14

For wetroom installation, reduce Side Panel Tray Finish Adjustment by 5mm.
Please note: Moving panel door must close onto the Side Panel.

Hinged Bifold Door / In Recess

Hinged Bifold Door / With Side Panel

technical drawing.

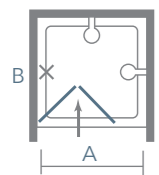

A: Door Opening
B: Width of panel when folded

Size	A	B
760	520	355
800	560	375
900	670	425
1000	780	475

Extension profiles available. See Page 107.



8^{MM}
GLASS
THICKNESS

LIFETIME
GUARANTEE

MERSHIELD
STAYCLEAR

1 Door Offset Quadrant

The stylish 8 Series Frameless Offset Quadrant comes in a range of sizes, providing a spacious showering space that would suit any type of bathroom, traditional or contemporary.

features.

- Height 2000mm
- Large horizontal designer handle
- Secure "Clunk" closing
- Ultra slim hinges
- Concealed fixing
- Reversible
- Wetroom compatible

1 Door Offset Quadrant					Add a Meryln MStone Tray		
Size	Tray Finish Adjustment	Order Code	Price £ Exc. VAT	Price £ Inc. VAT	Order Code*	Price £ Exc. VAT	Price £ Inc. VAT
900x760	880-900 740-760	A0601CH	1443.80	1732.56	A0601CHB Lor R	1680.30	2016.36
1000x800	980-1000 780-800	A0601EH	1399.83	1679.80	A0601EHB Lor R	1623.82	1948.58
1200x800	1180-1200 780-800	A0601HH	1455.08	1746.10	A0601HHB Lor R	1690.31	2028.37
1200x900	1180-1200 880-900	A0601IH	1455.08	1746.10	A0601IHB Lor R	1720.84	2043.41

*Order Code for ordering shower enclosure and tray.

Tray for this product is handed. Select L for Left or R for Right when choosing.

1 Door Offset Quadrant / Shown with Left Hand TrueStone tray (L)

technical drawing.

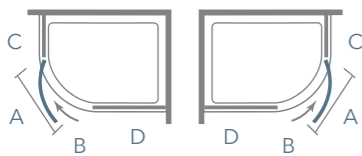

Size	A	B	C	D
900x760	720	790	195	335
1000x800	720	790	235	435
1200x800	720	790	235	635
1200x900	720	790	335	635

- A: Door Opening
- B: Door Swing
- C: Straight Panel
- D: Curved Panel

All sizes to suit a 550mm Radius Tray.
Extension profiles available. See Page 107.



8^{MM}
GLASS
THICKNESS

LIFETIME
GUARANTEE

MERSHIELD
STAYCLEAR

1 Door Quadrant

The 8 Series Frameless Quadrant with its beautiful curved glass is a definite style statement that would suit any type of bathroom, traditional or contemporary.

features.

- Height 2000mm
- Up to 8mm toughened glass
- Large horizontal designer handle
- Secure "Clunk" closing
- Ultra slim hinges
- Concealed fixing
- Reversible
- Wetroom compatible

1 Door Quadrant					Add a Meryln MStone Tray		
Size	Tray Finish Adjustment	Order Code	Price £ Exc. VAT	Price £ Inc. VAT	Order Code*	Price £ Exc. VAT	Price £ Inc. VAT
800	780-800	A0601TH	1168.92	1402.70	A0601THB	1327.83	1593.40
900	880-900	A0601UH	1168.92	1402.70	A0601UHB	1342.86	1611.43
1000	980-1000	A0602ZH	1263.27	1515.92	A0602ZHB	1490.22	1788.26

*Order Code for ordering shower enclosure and tray.

1 Door Quadrant

technical drawing.

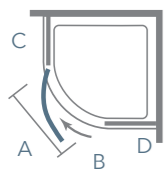

Size	A	B	C	D
800	720	790	235	235
900	720	790	335	335
1000	720	790	435	435

- A: Door Opening
- B: Door Swing
- C: Straight Panel
- D: Curved Panel

All sizes to suit a 550mm Radius Tray.
Extension profiles available. See Page 107.

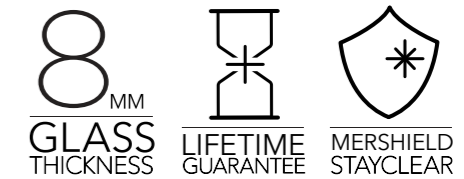

8 | series

If you are looking for a large selection of shapes to choose from, then 8 Series is the range for you. This range is a true style statement, with ingenious functionality. An excellent choice for all homeowners.

Why choose 8 Series?

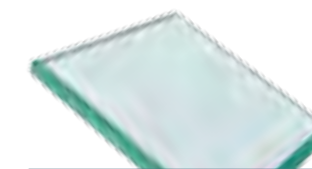

8mm covered

The 8mm glass in the 8 Series range is that great balance between our 10mm range and 6mm ranges. The glass is also toughened and tested rigorously to ensure maximum safety.

Easy clean double rollers



This feature on our 6 Series range is a great addition to make your enclosure the easiest to clean on the market. Simply push and release for easy cleaning in those hard to reach areas.

Every space covered

Not every space is the same, so Merlyn have designed a range of Inline Panels which can be added to standard enclosures to fit any width from 650mm to 1900mm. These ingenious semi-frameless panels, with a generous glass height of 1950mm, gives you options for almost any width you need.

Tested for quality & safety



All products are rigorously tested by us and by global health and safety experts to make sure they adhere to the highest quality standards (CE mark info page 109).

Ergonomic handle

The elegantly designed internal and external handles are designed to effortlessly close the shower to a solid "Clunk" each time you shower. With a beautiful solid chrome plated finish, it adds a designer touch to your enclosure.





8 MM
GLASS
THICKNESS

LIFETIME
GUARANTEE

MERSHIELD
STAYCLEAR

Sliding Door

The 8 Series Sliding door is an impressive and highly engineered spacious enclosure with 8mm toughened safety glass, 1950mm high and smooth gliding action based on quick release double rollers for easy cleaning.

features.

- Height 1950mm
- Translucent seals
- Concealed fittings
- Full length chrome magnetic strips
- Easy clean double rollers
- Chrome handle
- Reversible
- Wetroom compatible

Sliding Door					Add a Merlyn MStone Tray		
Size	Tray Finish Adjustment	Order Code	Price £ Exc. VAT	Price £ Inc. VAT	Order Code*	Price £ Exc. VAT	Price £ Inc. VAT
1000	950-990	M88231	739.76	887.71	MS88231	936.22	1123.46
1100	1050-1090	M88251	739.76	887.71	MS88251	959.99	1151.98
1200	1150-1190	M88241	739.76	887.71	MS88241	946.21	1135.45
1300 NEW	1250-1290	M88240	899.25	1079.10	MS88240	1209.25	1451.10
1400	1350-1390	M88291	935.19	1122.23	MS88291	1245.19	1494.23
1500	1450-1490	M88261	967.67	1161.20	MS88261	1321.05	1585.26
1600	1550-1590	M88271	979.60	1175.52	MS88271	1395.47	1674.57
1700	1650-1690	M88281	1027.32	1232.78	MS88281	1447.03	1736.43

*Order Code for ordering shower enclosure and tray.
Please add 20mm to Tray Finish Adjustment when using a Side Panel.

Optional Side Panel				
Size	Tray Finish Adjustment	Order Code	Price £ Exc. VAT	Price £ Inc. VAT
700	670-690	M82201	413.13	495.76
760	730-750	M82210	413.13	495.76
800	770-790	M82211	413.13	495.76
900	870-890	M82221	438.00	525.61
1000	970-990	M82231	480.19	576.22

Can be used with 2 optional Side Panels.
For wetroom installation, please reduce Side Panel Tray Finish Adjustment by 20mm.

Optional Inline Panel				
Size	Tray Finish Adjustment	Order Code	Price £ Exc. VAT	Price £ Inc. VAT
150	130-150	M8P140	248.52	298.22
210	190-210	M8P2200	260.23	312.28

Inline panels can be fitted to either or both sides of sliding door - See page 111 for space solutions.

Sliding Door / Shown with Side Panel

Sliding Door / In a Recess

technical drawing.

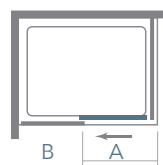

A: Door Opening
B: Fixed Panel

Extension profiles available. See Page 107.

Size	A	B
1000	390	440
1100	430	480
1200	470	530
1300	530	580
1400	570	630
1500	570	730
1600	570	830
1700	570	930



Hinge Door / Shown in a Recess

Hinge Door / With Side Panel

technical drawing.



A: Door Opening
B: Door Swing

Size	A	B
700	550	550
760	610	610
800	650	650
900	750	750
1000	850	850

Extension profiles available. See Page 107.

Hinge Door

A practical choice for larger en suites or smaller bathrooms. The Hinge Door offers a highly specified and versatile option, making it suitable for a large range of spaces.

features.

- Height 1950mm
- Concealed fittings
- Extended length chrome design symmetry handle
- Translucent seals
- Wetroom compatible
- Minimalist exposed glass edge
- Signature hinges with internal flush fixings
- Reversible
- Double bales catch closing with definitive "Clunk" close

Hinge Door					Add a Merlyn MStone Tray		
Size	Tray Finish Adjustment	Order Code	Price £ Exc. VAT	Price £ Inc. VAT	Order Code*	Price £ Exc. VAT	Price £ Inc. VAT
700	650-690	M81201	675.79	810.95	-	-	-
760	710-750	M81210	677.15	812.58	MS81210	787.15	944.58
800	750-790	M81211	677.15	812.58	MS81211	801.03	961.36
900	850-890	M81221	749.65	899.58	MS81221	923.59	1108.31
1000	950-990	M81231	793.67	952.40	MS81231	990.13	1188.15

*Order Code for ordering shower enclosure and tray. Please add 20mm to Tray Finish Adjustment when using a Side Panel.

Optional Side Panel				
Size	Tray Finish Adjustment	Order Code	Price £ Exc. VAT	Price £ Inc. VAT
700	670-690	M82201	413.13	495.76
760	730-750	M82210	413.13	495.76
800	770-790	M82211	413.13	495.76
900	870-890	M82221	438.01	525.61
1000	970-990	M82231	480.19	576.22

For wetroom installation, please reduce Side Panel Tray Finish Adjustment by 20mm.

Optional Inline Panel				
Size	Tray Finish Adjustment	Order Code	Price £ Exc. VAT	Price £ Inc. VAT
150	130-150	M8P140	248.52	298.23
210	190-210	M8P2200	260.23	312.27

Inline panels can be fitted to either or both sides of sliding door - See page 111 for space solutions. Please Note: Moving panel door must close onto the Side Panel.



Infold Door / Shown with Side Panel

Infold Door / In Recess

Infold Door / With Side Panel Overhead

technical drawing.

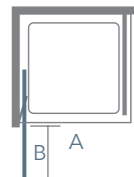

A: Door Opening
B: Door Swing

Size	A	B
700	505	200
760	565	260
800	605	300
900	705	400
1000	805	500

Extension profiles available. See Page 107.

Infold Door

This door is the epitome of space saving solutions without compromising on the beautiful lines of the glass door. Pair this 1950mm high 8 Series door with the minimalist optional Side Panel and this enclosure becomes ideal for any corner setting.

features.

- Height 1950mm
- Concealed fittings
- Chrome design symmetry handle
- Reversible
- Wetroom compatible
- Translucent seals

Infold Door					Add a Merlyn MStone Tray		
Size	Tray Finish Adjustment	Order Code	Price £ Exc. VAT	Price £ Inc. VAT	Order Code*	Price £ Exc. VAT	Price £ Inc. VAT
700	650-690	M84401	715.90	859.08	-	-	-
760	710-750	M84410	727.84	873.41	MS84410	827.26	992.71
800	750-790	M84411	742.15	890.58	MS84411	866.03	1039.23
900	850-890	M84421	752.76	903.31	MS84421	926.70	1112.04
1000	950-990	M84431	819.37	983.24	MS84431	1015.83	1218.99

*Order Code for ordering shower enclosure and tray.
Please add 20mm to Tray Finish Adjustment when using a Side Panel.

Optional Side Panel				
Size	Tray Finish Adjustment	Order Code	Price £ Exc. VAT	Price £ Inc. VAT
700	670-690	M82201	413.13	495.76
760	730-750	M82210	413.13	495.76
800	770-790	M82211	413.13	495.76
900	870-890	M82221	438.01	525.61
1000	970-990	M82231	480.19	576.23

For wetroom installation, please reduce Side Panel Tray Finish Adjustment by 20mm.

Optional Inline Panel				
Size	Tray Finish Adjustment	Order Code	Price £ Exc. VAT	Price £ Inc. VAT
150	130-150	M8P140	248.52	298.22
210	190-210	M8P2200	260.23	312.28

Inline Panels can be fitted to either or both sides of sliding door - See page 111 for space solutions.



1 Door Offset Quadrant / Shown on Right Hand (R) 1400x800 size available

1 Door Offset Quadrant

With fresh curved lines and designer chrome handles, the 1 Door Offset Quadrant exudes traditional style with a contemporary twist and a strong focus on expert engineering.

features.

- Height 1950mm
- Concealed fittings
- Chrome design symmetry handle
- Reversible
- Wetroom compatible
- Translucent seals

1 Door Offset Quadrant					Add a Merlyn MStone Tray		
Size	Tray Finish Adjustment	Order Code	Price £ Exc. VAT	Price £ Inc. VAT	Order Code*	Price £ Exc. VAT	Price £ Inc. VAT
900x760	875-895 735-755	M83222	1091.72	1310.06	MS83222 L or R	1328.22	1593.87
1000x800	975-995 775-795	M83233	1061.33	1273.59	MS83233 L or R	1257.79	1509.34
1200x800	1175-1195 775-795	M83243	1062.46	1274.95	MS83243 L or R	1273.93	1528.72
1200x900	1175-1195 875-895	M83241	1062.46	1274.95	MS83241 L or R	1310.22	1572.26
1400x800	1375-1395 775-795	M83244	1106.98	1328.38	MS83244 L or R	1382.09	1658.51

*Order Code for ordering shower enclosure and tray. Tray for this product is handed. Select L for Left or R for Right when choosing.

Merlyn Dedicated Offset Quadrant Tray (1400x800)			
Size	Order Code	Price £ Exc. VAT	Price £ Inc. VAT
1400x800	S148Q L or R	275.11	330.13

This product is handed please choose L for left and R for right when ordering. Please Note: The 1400x800mm tray is not an MStone Tray, it is a dedicated single skinned tray. For wetroom installation, please reduce Side Panel Tray Finish Adjustment by 20mm.

technical drawing.

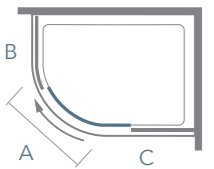

Size	A	B	C
900x760	420	540	275
1000x800	425	520	375
1200x800	425	520	575
1200x900	480	540	575
1400x800	425	540	775

A: Door Opening
B: Fixed Panel
C: Straight Panel

All sizes to suit a 550mm Radius Tray. Extension profiles available. See Page 107.



8^{MM}
GLASS
THICKNESS

LIFETIME
GUARANTEE

MERSHIELD
STAYCLEAR

1 Door Quadrant

With fresh curved lines and designer chrome handles, the 1 Door Quadrant exudes traditional style with a contemporary twist and a strong focus on expert engineering.

features.

- Height 1950mm
- 8mm toughened glass
- Translucent seals
- Concealed fittings
- Easy clean double rollers
- Chrome design symmetry handle
- Reversible
- Wetroom compatible

1 Door Quadrant					Add a Merlyn MStone Tray		
Size	Tray Finish Adjustment	Order Code	Price £ Exc. VAT	Price £ Inc. VAT	Order Code*	Price £ Exc. VAT	Price £ Inc. VAT
900	875-895	M83225	942.03	1130.43	MS83225	1115.97	1339.17

*Order code for ordering shower enclosure with tray.
For wetroom installation, please reduce Side Panel Tray Finish Adjustment by 20mm.

1 Door Quadrant

technical drawing.

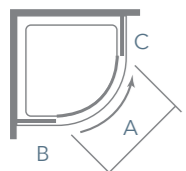

Size	A	B	C
900x900	480	540	275

A: Door Opening
B: Fixed Panel
C: Straight Panel

All sizes to suit a 550mm Radius Tray.
Extension profiles available. See Page 107.



2 Door Quadrant

2 Door Quadrant

With fresh curved lines and designer chrome handles, the 2 Door Quadrant exudes traditional style with a contemporary twist and a strong focus on expert engineering.

features.

- Height 1950mm
- 8mm toughened glass
- Mershield Stayclear easy clean protected glass
- Lifetime Guarantee
- Translucent seals
- Concealed fittings
- Easy clean double rollers
- Chrome design symmetry handle
- Reversible
- Wetroom compatible

2 Door Quadrant					Add a Merlyn MStone Tray		
Size	Tray Finish Adjustment	Order Code	Price £ Exc. VAT	Price £ Inc. VAT	Order Code*	Price £ Exc. VAT	Price £ Inc. VAT
800	775-795	M83211	861.04	1033.25	MS83211	1019.96	1223.95
900	875-895	M83221	861.04	1033.25	MS83221	1034.98	1241.98
1000	975-995	M83231	1056.81	1268.17	MS83231	1283.76	1504.51

*Order code for ordering shower enclosure with tray.
For wetroom installation, please reduce Side Panel Tray Finish Adjustment by 20mm.

technical drawing.

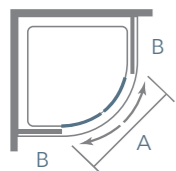

A: Door Opening
B: Fixed Panel

Size	A	B
800	410	220
900	540	320
1000	540	420

All sizes to suit a 550mm Radius Tray.
Extension profiles available. See Page 107.

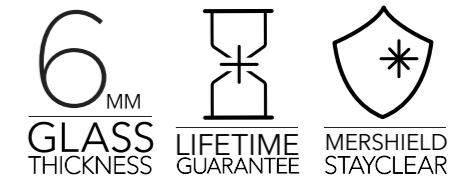

6 | series | *frameless*

An elegant range of enclosures designed to offer a frameless look for any bathroom space. The beautifully crafted hinges and stabilising bars would suit both contemporary or traditionally styled bathrooms.

Why choose 6 Series frameless?

Discreet designer stabilising bar

This range offers a designer bracing bar that blends seamlessly into the glass, ensuring a secure and frameless feature within your bathroom.

Luxury solid metal handle

This range ensures minimalist elegance in every detail, including the luxury solid handle that comes as standard.

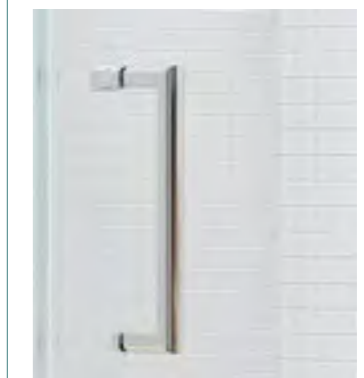

Fusion of elegance and functionality

This range offers a towering glass height of 2000mm while maintaining its luxurious frameless design.



6
MM
GLASS
THICKNESS

LIFETIME
GUARANTEE

MERSHIELD
STAYCLEAR

Hinge and Inline / With Side Panel

Stablising Bar

technical drawing.

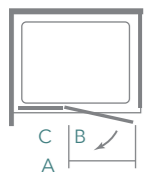

A: Door Opening
B: Door Swing
C: Fixed Panel

Extension profiles available. See Page 107.

Size	A	B	C	Size	A	B	C
760	440	460	160	1100	630	610	350
800	440	460	200	1200	590	650	450
800+	480	500	200	1200+	630	610	450
900	490	510	250	1400	590	650	650
900+	530	550	250	1400+	630	610	650
1000	540	560	300	1500	590	650	750
1000+	580	600	350	1500+	630	610	750
1100	590	650	350				

Hinge and Inline

The new 6 Series Frameless Hinge & Inline Door is the perfect fusion between minimalist elegance and practical functionality. The luxuriously frameless design combined with the precision engineered chrome hinge, makes this a real statement piece.

features.

- Height 2000mm
- 8mm toughened glass
- 6mm moving panel
- Mershield Stayclear easy clean protected glass
- Luxury solid metal handle
- Sleek designer bracing bar
- Lifetime Guarantee
- Reversible

Hinge & Inline in Recess					Add an MStone Tray		
Size	Tray Finish Adjustment	Order Code	Price £ Exc. VAT	Price £ Inc. VAT	Order Code*	Price £ Exc. VAT	Price £ Inc. VAT
760	720-760	S6F760REC	534.57	641.48	S6FB760REC	645.93	775.12
800	760-800	S6F800REC	544.87	653.84	S6FB800REC	668.75	802.50
800+	800-840	S6F800CORN	544.87	653.84	S6FB800CORN	668.75	802.50
900	860-900	S6F900REC	565.47	678.56	S6FB900REC	739.41	887.30
900+	900-940	S6F900CORN	565.47	678.56	S6FB900CORN	739.41	887.30
1000	960-1000	S6F1000REC	606.67	728.00	S6FB1000REC	803.13	963.75
1000+	1000-1040	S6F1000CORN	606.67	728.00	S6FB1000CORN	803.13	963.75
1100	1060-1100	S6F1100RECH	637.57	765.08	S6FB1100RECH	857.80	1029.36
1100+	1100-1140	S6F1100CORNH	637.57	765.08	S6FB1100CORNH	857.80	1029.36
1200	1160-1200	S6F1200RECH	658.17	789.80	S6FB1200RECH	864.62	1037.55
1200+	1200-1240	S6F1200CORNH	658.17	789.80	S6FB1200CORNH	864.62	1037.55
1400	1360-1400	S6F1400RECH	699.37	839.24	S6FB1400RECH	1009.37	1211.25
1400+	1400-1440	S6F1400CORNH	699.37	839.24	S6FB1400CORNH	1009.37	1211.25
1500	1460-1500	S6F1500RECH	730.27	876.32	S6FB1500RECH	1083.65	1300.38
1500+	1500-1540	S6F1500CORNH	730.27	876.32	S6FB1500CORNH	1083.65	1300.38

Hinge & Inline with a Side Panel					Add an MStone Tray		
Size	Tray Finish Adjustment	Order Code	Price £ Exc. VAT	Price £ Inc. VAT	Order Code*	Price £ Exc. VAT	Price £ Inc. VAT
800+	780-800	S6F800CORN	544.87	653.84	S6FB800CORN	668.75	802.50
900+	880-900	S6F900CORN	565.47	678.56	S6FB900CORN	739.41	887.30
1000+	980-1000	S6F1000CORN	606.67	728.00	S6FB1000CORN	803.13	963.75
1100+	1080-1100	S6F1100CORNH	637.57	765.08	S6FB1100CORNH	857.80	1029.36
1200+	1180-1200	S6F1200CORNH	658.17	789.80	S6FB1200CORNH	864.62	1037.55
1400+	1380-1400	S6F1400CORNH	699.37	839.24	S6FB1400CORNH	1009.37	1211.25
1500+	1480-1500	S6F1500CORNH	730.27	876.32	S6FB1500CORNH	1083.65	1300.38

Optional Side Panel to match + sizes only				
Size	Tray Finish Adjustment	Order Code*	Price £ Exc. VAT	Price £ Inc. VAT
760	720-760	S6F760SP	270.89	325.07
800	760-800	S6F800SP	277.07	332.48
900	860-900	S6F900SP	297.67	357.20

For Wetroom instal-uce min/max adjustment by 10mm.

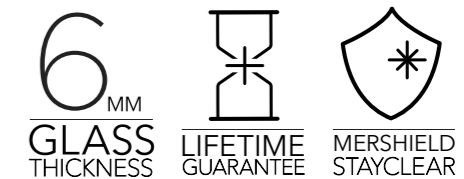

6 | series

The 6 Series range is the perfect choice if you are looking for a portfolio of shower enclosures to accommodate any space and design requirements.

Why choose 6 Series?

Easy clean double rollers



This feature on our 6 Series range makes your enclosure the easiest to clean on the market. Simply push and release for easy cleaning in those hard to reach areas.



Tested for quality & safety

All products are rigorously tested by us and by global health and safety experts to make sure they adhere to the highest quality standards (CE mark info page 109).

A great range at a great price

The Merlyn 6 Series range offers all the benefits, design and technology of the Series Collection but at more accessible prices. This range delivers on style, function and value for money.

Chrome dual handle

A luxurious chrome dual handle complements the look of this framed range of enclosures with a discreet inside handle and larger external handle for easy closing.



Every space covered

Not every space is the same, so Merlyn have designed a range of Inline Panels which can be added to standard enclosures to fit any width from 670mm to 1915mm. These ingenious semi-frameless panels, with a generous glass height of 1900mm, gives you options for almost any width you need.



Sliding Door / Shown with Side Panel

Sliding Door / Shown as Left Hand (L)

technical drawing.

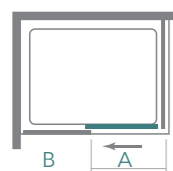

A: Door Opening
B: Fixed Panel

Extension profiles available. See Page 107.

Size	A	B
1000	380	420
1100	430	470
1200	480	520
1400	580	620
1500	580	720
1600	580	820
1700	580	920

Sliding Door

The 6 Series Sliding Door has been enhanced with designer handles and quick release double rollers for easy access cleaning. With exceptionally smooth opening, this enclosure which stands at 1900mm high is affordable yet incredibly stylish.

features.

- Height 1900mm
- 6mm toughened glass
- Translucent seals
- Full length chrome magnetic strips
- Easy clean double rollers
- Double handed
- Can be used with 2 optional minimalist Side Panels
- Reversible
- Wetroom compatible

Sliding Door					Add a Merlyn MStone Tray		
Size	Tray Finish Adjustment	Order Code	Price £ Exc. VAT	Price £ Inc. VAT	Order Code*	Price £ Exc. VAT	Price £ Inc. VAT
1000	950-1000	M68231	527.66	633.19	MS68231	724.11	868.94
1100	1050-1100	M68251	527.66	633.19	MS68251	747.89	897.47
1200	1150-1200	M68241	527.66	633.19	MS68241	734.11	880.93
1400	1350-1400	M68291	647.67	777.21	MS68291	957.68	1149.21
1500	1450-1500	M68261	689.78	827.74	MS68261	1043.16	1251.79
1600	1550-1600	M68271	728.75	874.49	MS68271	1144.62	1373.54
1700	1650-1700	M68281	728.75	874.49	MS68281	1225.00	1470.00

*Order code for ordering shower enclosure and tray. Please add 20mm to Tray Finish Adjustment when using a Side Panel.

Optional Side Panel				
Size	Tray Finish Adjustment	Order Code	Price £ Exc. VAT	Price £ Inc. VAT
700	680-705	M62201N	300.38	360.46
760 / 800	745-790	M62211N	270.34	324.41
900	875-900	M62221N	287.68	345.21
1000	975-1000	M62231N	318.87	382.64

For wetroom installation, please reduce Side Panel Tray Finish Adjustment by 20mm.

Optional Inline Panel				
Size	Tray Finish Adjustment	Order Code	Price £ Exc. VAT	Price £ Inc. VAT
140	115-140	M61125	235.65	282.78
215	190-215	M61200	247.49	296.99

Inline panels can be fitted to either or both sides of sliding door. See page 110 for space solutions.



Pivot Door / Shown as Left Hand (L)

technical drawing.

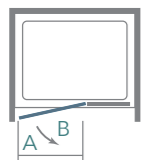

A: Door Opening
B: Door Swing

Size	A	B
700	410	410
760/800	480	480
900	590	590
1000	690	690

Note: Side Panel is 6mm glass
Extension profiles available. See Page 107.

Pivot Door

At 1900mm high the 6 Series Pivot Door is a chic space saving solution. The 8mm toughened safety glass door pivots on elegant chrome mechanisms and with the addition of the minimalist glass edged side panel, it's perfect for any corner situation.

features.

- Height 1900mm
- Double bales catch closing with definitive "Clunk" close
- Solid metal minimalist pivots
- Translucent seals
- Easy clean double rollers
- Double handed
- Reversible
- Wetroom compatible

Pivot Door					Add a Merlyn MStone Tray		
Size	Tray Finish Adjustment	Order Code	Price £ Exc. VAT	Price £ Inc. VAT	Order Code*	Price £ Exc. VAT	Price £ Inc. VAT
700	670-720	M61201	380.11	456.13	-	-	-
760/800	740-790	M61211	427.95	513.55	MS61211	539.32	647.18
900	850-900	M61221	448.64	538.36	MS61221	622.58	747.10
1000	950-1000	M61231	472.90	567.36	MS61231	669.36	803.23

*Order Code for ordering shower enclosure and tray.
Please add 10mm to Tray Finish Adjustment when using a Side Panel.

Optional Side Panel				
Size	Tray Finish Adjustment	Order Code	Price £ Exc. VAT	Price £ Inc. VAT
700	680-705	M62201	300.38	360.45
760 / 800	745-790	M62211	270.34	324.41
900	875-900	M62221	287.68	345.21
1000	975-1000	M62231	318.87	382.64

For wetroom installation, please reduce Tray Finish Adjustment by 20mm.

Optional Inline Panel				
Size	Tray Finish Adjustment	Order Code	Price £ Exc. VAT	Price £ Inc. VAT
140	115-140	M61125	235.65	282.78
215	190-215	M61200	247.49	296.99

Inline Panels can be fitted to either or both sides of sliding door. See page 110 for space solutions.



6^{MM}
GLASS
THICKNESS

LIFETIME
GUARANTEE

MERSHIELD
STAYCLEAR

Bifold Door / Shown with Side Panel

Bifold Door / In a Recess

Bifold Door

Where space is at a premium the 6 Series Bifold is the ultimate solution. This new version of a classic shape, offers a sleek frameless design with a discreet chrome hinge detail.

features.

- Height 1900mm
- Discreet chrome bifold hinge
- Sleek frameless door design
- Reversible
- Wetroom compatible

Bifold Door					Add a Merlyn MStone Tray		
Size	Tray Finish Adjustment	Order Code	Price £ Exc. VAT	Price £ Inc. VAT	Order Code*	Price £ Exc. VAT	Price £ Inc. VAT
700	670-720	M67201 N	590.15	708.18	-	-	-
760/800	740-790	M67211 N	590.15	708.18	M67211B	701.51	841.81
900	850-900	M67221 N	632.55	759.06	M67221B	806.50	967.80
1000	950-1000	M67231 N	665.27	798.32	M67231B	861.72	1034.07

*Order Code for ordering shower enclosure and tray.
Can be used with 2 optional minimalist Side Panels.
Please add 10mm to Tray Finish Adjustment when using a Side Panel.

Optional Side Panel				
Size	Tray Finish Adjustment	Order Code	Price £ Exc. VAT	Price £ Inc. VAT
700	680-705	M62201	300.38	360.46
760/800	745-790	M62211	270.34	324.41
900	875-900	M62221	287.68	345.22
1000	975-1000	M62231	318.87	382.64

For wetroom installation, please reduce Side Panel Tray Finish Adjustment by 20mm.

Optional Inline Panel				
Size	Tray Finish Adjustment	Order Code	Price £ Exc. VAT	Price £ Inc. VAT
140	115-140	M61125	235.65	282.78
215	190-215	M61200	247.49	296.99

Inline Panels can be fitted to either or both sides of sliding door. See page 110 for space solutions.

technical drawing.

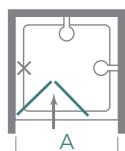

X: Do not put shower head here
A: Door Opening

Size	A
700	420
760/800	490
900	600
1000	650

Extension profiles available. See Page 107.



6^{MM}
GLASS
THICKNESS

LIFETIME
GUARANTEE

MERSHIELD
STAYCLEAR

1 Door Quadrant

The 6 Series Quadrants have it all - 1900mm high with a beautiful chrome elliptical frame, 6mm toughened glass, designer handles and quick release double rollers for easy access to clean - stylish yet very affordable.

features.

- Height 1900mm
- Translucent seals
- Easy clean double rollers
- Double handed
- Single sliding door
- Reversible
- Wetroom compatible

1 Door Quadrant					Add a Merlyn MStone Tray		
Size	Tray Finish Adjustment	Order Code	Price £ Exc. VAT	Price £ Inc. VAT	Order Code*	Price £ Exc. VAT	Price £ Inc. VAT
900	875-900	M63225	683.02	819.63	MS63225	856.97	1028.36

1 Door Offset Quadrant					Add a Merlyn MStone Tray		
Size	Tray Finish Adjustment	Order Code	Price £ Exc. VAT	Price £ Inc. VAT	Order Code*	Price £ Exc. VAT	Price £ Inc. VAT
900x760	875-900 735-760	M63222	758.56	910.28	MS63222 LorR	995.07	1194.08
1000x800	975-1000 775-800	M63233	899.87	1079.84	MS63233 LorR	1123.86	1348.63
1200x800	1175-1200 775-800	M63243	899.87	1079.84	MS63243 LorR	1135.10	1362.12
1200x900	1175-1200 875-900	M63241	899.87	1079.84	MS63241 LorR	1147.63	1377.15

*Order code for ordering shower enclosure with tray. For wetroom installation, please reduce Tray Finish Adjustment by 20mm. Tray for this product is handed. Select L for Left or R for Right when choosing.

technical drawing.

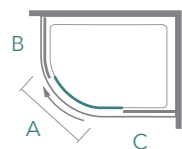

A: Door Panel
B: Curved Panel
C: Straight Panel

Size	A	B	C
900x760	405	460	280
900x900	480	540	250
1000x800	430	495	380
1200x800	430	495	580
1200x900	480	540	580

All sizes to suit a 550mm Radius Tray. Extension profiles available. See Page 107.



6^{MM}
GLASS
THICKNESS

LIFETIME
GUARANTEE

MERSHIELD
STAYCLEAR

2 Door Quadrant

The 6 Series Quadrants have it all, 1900mm high with a beautiful chrome elliptical frame, 6mm toughened glass, designer handles and quick release double rollers for easy access to clean - stylish yet very affordable.

features.

- Height 1900mm
- Translucent seals
- Full length chrome magnetic strips
- Easy clean double rollers
- Double handed
- Double sliding door
- Reversible
- Wetroom compatible

2 Door Quadrant					Add a Merlyn MStone Tray		
Size	Tray Finish Adjustment	Order Code	Price £ Exc. VAT	Price £ Inc. VAT	Order Code*	Price £ Exc. VAT	Price £ Inc. VAT
800	775-800	M63211	577.58	693.10	MS63211	736.50	883.80
900	875-900	M63221	577.58	693.10	MS63221	751.53	901.83
1000	975-1000	M63231	726.57	871.89	MS63231	950.56	1140.67

*Order code for ordering shower enclosure with tray.
For wetroom installation, please reduce Side Panel Tray Finish Adjustment by 20mm.

2 Door Quadrant

technical drawing.

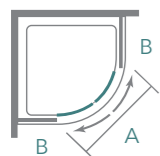

Size	A	B
800	375	225
900	540	325
1000	540	425

A: Door Opening
B: Fixed Panel

All sizes to suit a 550mm Radius Tray.
Extension profiles available. See Page 107.



6^{MM}
GLASS
THICKNESS

LIFETIME
GUARANTEE

MERSHIELD
STAYCLEAR

Corner Door

The 6 Series Corner door is a functional and contemporary enclosure. It is the perfect solution for bijoux en suites or awkward spaces as the doors slide back within the confines of the shower itself.

features.

- Height 1900mm
- Translucent seals
- Easy clean double rollers
- Double handed
- Double sliding doors
- Reversible
- Wetroom compatible

2 Door Quadrant					Add a Merlyn MStone Tray		
Size	Tray Finish Adjustment	Order Code	Price £ Exc. VAT	Price £ Inc. VAT	Order Code*	Price £ Exc. VAT	Price £ Inc. VAT
800	775-800	M65211	662.08	794.50	MS65211	785.96	943.16
900	875-900	M65221	728.66	874.40	MS65221	902.61	1083.13

*Order code for ordering shower enclosure with tray.
For wetroom installation, please reduce Tray Finish Adjustment by 20mm.

Corner Door

technical drawing.

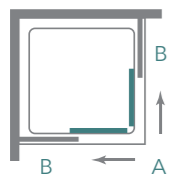

Size	A	B
800	395	310
900	465	360

A: Door Opening
B: Fixed Panel

Extension profiles available. See Page 107.



10_{MM}
GLASS
THICKNESS
8_{MM}
GLASS
THICKNESS
LIFETIME
GUARANTEE
MERSHIELD
STAYCLEAR

Wetrooms

Merlyn Wetrooms offers you the ultimate in versatility and luxury. Whether you are after the New York style loft appeal or you need to create a bathroom with inclusive design, then Showerwalls and Wetrooms are the solution for you.

Why choose Merlyn Wetrooms?

Choice of glass

Available in 10mm and 8mm glass and up to a height of 2015mm, the Merlyn Wetrooms offer you choice to suit what it is you want.

A showerwall even for small spaces

The Merlyn Single and Double Folding Showerwall are the solution to create a wetroom finish within bathrooms that have space restrictions. Merlyn help you have what you want.

A solution for every situation

The Merlyn Wetrooms provide several additional options to complement your showerwall for whatever you need to achieve within your bathroom.





10 Series Showerwall / With Wall Profile only



Showerwall / With Swivel Panel (D)



Showerwall / With Cube Panel (E)



Showerwall / With Vertical Post (F)

10^{MM}
GLASS
THICKNESS

LIFETIME
GUARANTEE

MERSHIELD
STAYCLEAR

Wetrooms

Luxurious Wetroom Panels, crafted with our signature 10mm glass. Each showerwall comes with a wall profile you can tailor with various options such as; stabilising bars, end, swivel or cube panels and flush wall and floor profiles. Pick and choose from the 9 additional options to give your wetroom the luxurious finish.

features.

- Height 2000mm
- 10mm toughened glass
- Mershield Stayclear easy clean protected glass
- Choice of additional options to tailor your wetroom to suit your space
- Suitable for recess or corner situation
- Suitable for wetroom and shower tray application
- Reversible
- Lifetime Guarantee

10 Series Showerwall (including Wall Profile only)						Showerwall with Straight Stabilising Bar (including Wall Profile)			
Size	Tray Finish Adjustment	Glass Type	Order Code	Price £ Exc.VAT	Price £ Inc. VAT	Additional Code*	Order Code*	Price £ Exc.VAT	Price £ Inc. VAT
300**	275-290	Clear	S10SW300	305.00	366.00	A	S10SW300H	469.3	563.16
400**	375-390	Clear	S10SW400	313.37	376.04	A	S10SW400H	477.67	573.20
500**	475-490	Clear	S10SW500	372.78	447.34	A	S10SW500H	537.08	644.50
600**	575-590	Clear	S10SW600	418.21	501.85	A	S10SW600H	582.51	699.01
700**	675-690	Clear	S10SW700	441.51	529.81	A	S10SW700H	605.81	726.97
800**	775-790	Clear	S10SW800	464.81	557.77	A	S10SW800H	629.11	754.93
900**	875-890	Clear	S10SW900	488.11	585.73	A	S10SW900H	652.41	782.89
1000	975-990	Clear	S10SW1000	499.76	599.71	A	S10SW1000H	664.06	796.87
1100	1075-1090	Clear	S10SW1100	534.71	641.65	A	S10SW1100H	699.01	838.81
1200	1175-1190	Clear	S10SW1200	569.65	683.58	A	S10SW1200H	733.95	880.74
1400	1375-1390	Clear	S10SW1400	627.90	753.48	A	S10SW1400H	792.20	950.64

*Order code for ordering shower enclosure with tray.
 **Please Note: These sizes are the only sizes we recommend for use as end panels. We recommend a minimum opening space of 500mm.

Additional Options				
	Size mm	Order Code**	Price £ Exc. VAT	Price £ Inc. VAT
A) Straight Stabilising Bar*	max 1 metre	SP0S8TRSET N	164.30	197.16
B) Angled Stabilising Bar	350	SP08SCU12320	92.22	110.66
C) T Bracket (to connect 2 stabilising bars)	N/A	SP0S8RTPSET	42.40	50.88
D) Swivel Panel 8mm glass	300	M8SW530 N	240.68	288.82
E) Cube Panel 8mm glass**	300	A0413F0 N	150.28	180.34
F) Vertical Post	max 3 metres	A0417C0 N	147.44	176.93
G) Flush Wall Profile	max 2000	SP02000FWP	33.78	40.54
H) Flush Floor Profile	max 1400	SP01400FFP	27.96	33.55
I) U channel	max 1400	MGVC35A	28.36	34.03
J) Glass to glass profile	2000	A04S0009	43.68	52.42

*Please Note: We recommend the use of a stabilising bar for any Showerwall over 900mm.
 **Cube Panel must be fitted on a flat tray/wetroom situation.



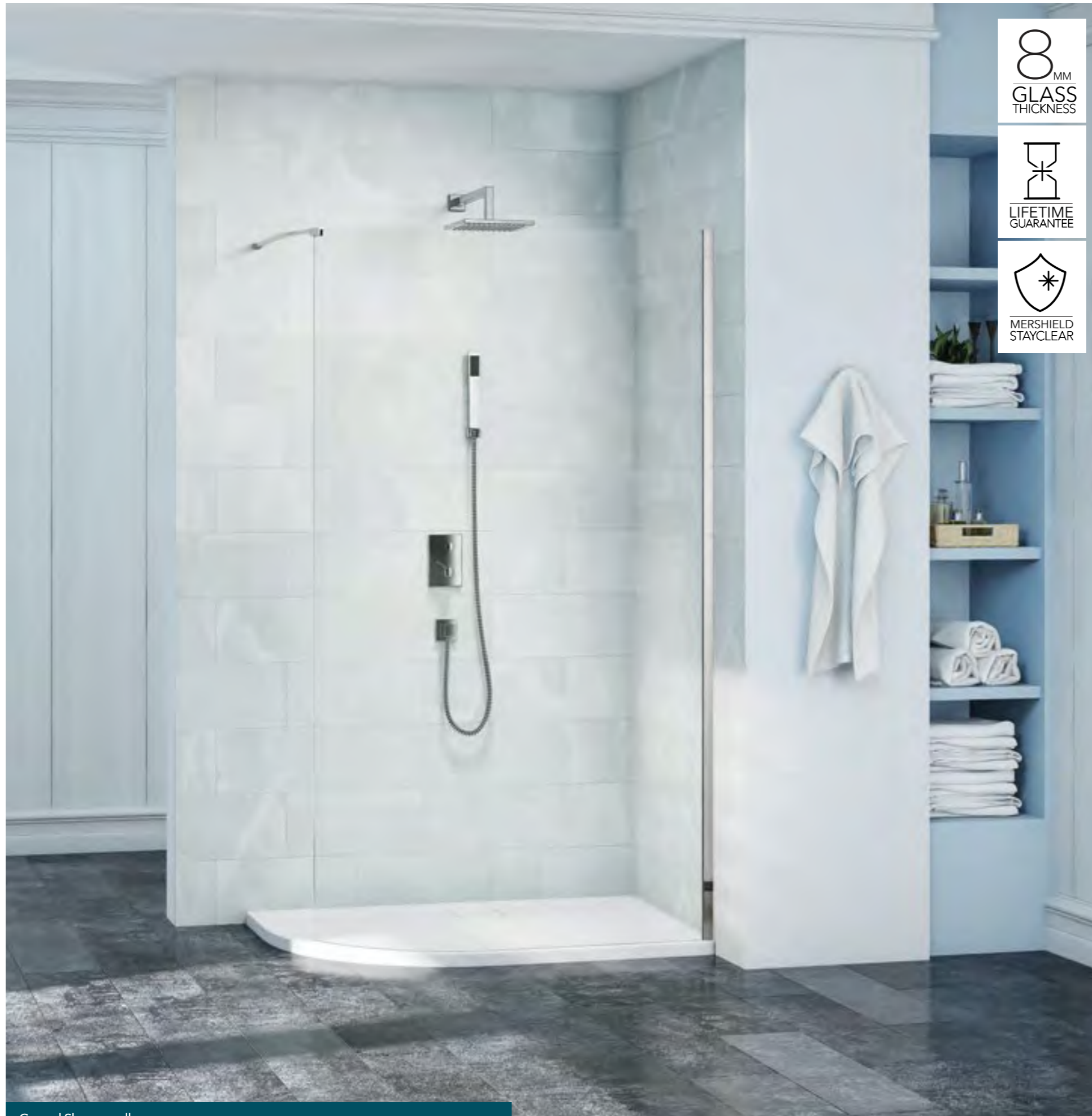

8
MM
GLASS
THICKNESS

LIFETIME
GUARANTEE

MERSHIELD
STAYCLEAR

Curved Showerwall

The beautiful curved glass of the new 8 Series Curved Showerwall follows the contour of your offset quadrant tray, giving a softer finish. The extra length of the curved panel also deflects water spray inwards. This frameless design boasts Mershield Stayclear, ensuring peace of mind with the Merlyn Lifetime Guarantee.

features.

- Height 2015mm including rail
- Minimalist frameless design
- Reversible
- Suitable for wetroom and shower tray application
- Can be used with 800mm and 900mm trays

Curved showerwall					Add a Merlyn MStone Tray			
Size	Tray Finish Adjustment	Order Code*	Price £ Exc. VAT	Price £ Inc. VAT	Tray Size	Order Code*	Price £ Exc. VAT	Price £ Inc. VAT
900	885-900	S8CURV900	729.00	874.80	900x900	S8CURV900B	965.50	1158.60
1000	985-1000	S8CURV1000	769.00	922.80	1000x900	S8CURV1000B L or R	992.99	1191.59
1200	1185-1200	S8CURV1200	839.00	1006.80	1200x900	S8CURV1200B L or R	1074.23	1289.08

*Order code for ordering shower enclosure with tray.

Curved Showerwall

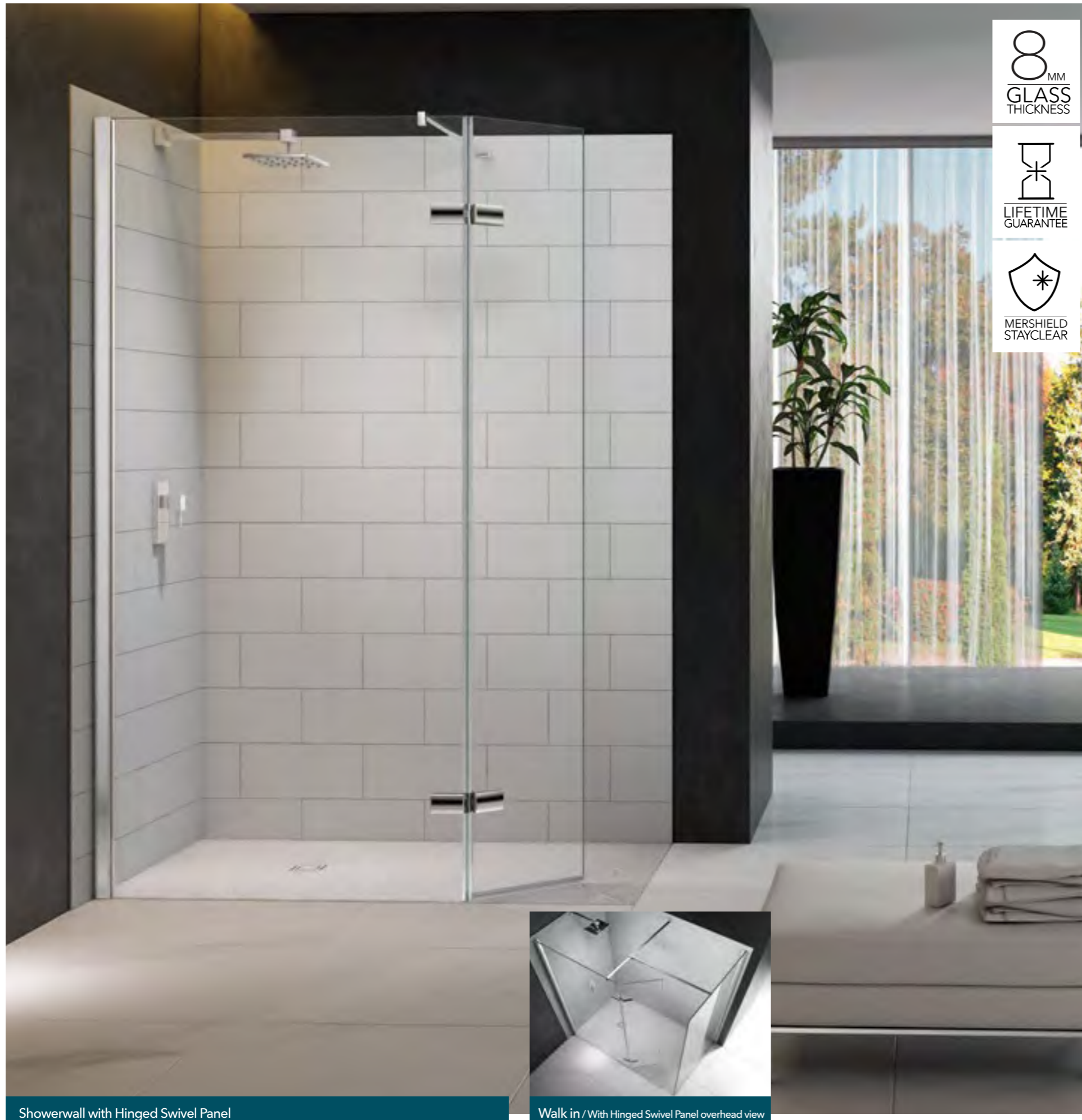

8 MM
GLASS
THICKNESS

LIFETIME
GUARANTEE

MERSHIELD
STAYCLEAR

Showerwall with Hinged Swivel Panel

Walk in / With Hinged Swivel Panel overhead view

Hinged Swivel Panel

The 8 Series Hinged Swivel Panel features 2 beautifully crafted designer hinges that give this door a stunning frameless and minimalist finish. The stylish yet understated model is flexible in terms of options and is available with or without an End Panel.

features.

- Height 2015mm including rail
- Minimalist frameless design
- Swivel Panel can be adjusted to deflect shower spray
- Suitable for wetroom and shower tray application
- Reversible

Showerwall with Hinged Swivel Panel						Add a Merlyn MStone Tray			
Size	Front Panel Size mm	Swivel Panel Size mm	Order Code	Price £ Exc.VAT	Price £ Inc. VAT	Tray Size	Order Code*	Price £ Exc. VAT	Price £ Inc. VAT
1050	700	350	M8SW251	640.70	768.83	1200x900	M8SW1100HB	864.69	1037.62
1250	900	350	M8SW261	676.92	812.30	1400x900	M8SW1200HB	999.68	1199.62
1350	1000	350	M8SW271	693.90	832.68	1500x900	M8SW1300HB	1030.30	1236.36
						1500x900	M8SW1400HB	1047.28	1256.73
						1600x900	M8SW1500HB	1109.77	1331.73

*Order code for ordering shower enclosure with tray
Please Note: We recommend a minimum opening space of 500mm.

Walk In with Hinged Swivel Panel						Add a Merlyn MStone Tray			
Area mm	Panel Size mm (Front+Swivel+End Panel)	Opening mm	Order Code	Price £ Exc. VAT	Price £ Inc. VAT	Tray Size	Order Code*	Price £ Exc. VAT	Price £ Inc. VAT
1200x800	700+350+800	500	M8SWS100H	1201.19	1441.43	1200x800	M8SW1100HB	1412.66	1695.19
1200x900	700+350+900	500	M8SWS400H	1227.47	1472.97	1200x800	M8SW600HB	1451.46	1741.75
1400x800	900+350+800	500	M8SWS200H	1237.41	1484.90	1400x800	M8SW200HB	1547.41	1856.89
1400x800	900+350+800	600		1500x800	M8SW300HB	1607.77	1929.32		
1400x900	900+350+900	500	M8SWS500H	1263.70	1516.44	1400x900	M8SW700HB	1586.46	1903.75
1500x900	900+350+900	600		1500x900	M8SW800HB	1634.06	1960.87		
1500x800	1000+350+800	500	M8SWS300H	1254.39	1505.27	1500x800	M8SW400HB	1607.77	1929.32
1600x800	1000+350+800	600		1600x800	M8SW500HB	1670.26	2004.32		
1500x900	1000+350+900	500	M8SWS600H	1280.68	1536.81	1500x900	M8SW900HB	1634.06	1960.87
1600x900	1000+350+900	600		1600x900	M8SW1000HB	1696.55	2035.86		

Please Note: We recommend a minimum opening space of 500mm.



Folding Showerwall / 8 Series



Folding Showerwall / 8 Series Double

Folding Showerwall - Single and Double

The 8 Series Folding Showerwall is an ingenious space saving solution for bathrooms with space restrictions. The hero of the bijoux bathroom. Folding away neatly and horizontally flush to the wall, this screen allows you to double your feeling of space in any small bathroom giving you that space you desire.

features.

- Height 1950mm
- Minimalist frameless design
- Suitable for wetroom situation only
- Reversible
- Space solution
- Minimalist designer hinges

Folding Showerwall				
Size	Adjustment	Order Code	Price £ Exc. VAT	Price £ Inc. VAT
760	680-700	M87111	655.41	786.49
800	720-740	M87211	678.05	813.66
900	820-840	M87221	722.19	866.63
1000	920-940	M87231	745.97	895.16

Please Note: We recommend fitting this product in a Wetroom situation only.

Double Folding Showerwall				
Size	Adjustment	Order Code	Price £ Exc. VAT	Price £ Inc. VAT
760x760	715-735	M86101H	1272.64	1527.17
800x800	755-775	M86102H	1316.60	1579.92
900x900	855-875	M86103H	1402.32	1682.79
1000x1000	955-975	M86104H	1448.48	1738.18

Please Note: We recommend fitting this product in a Wetroom situation only.



8^{MM}
GLASS
THICKNESS

LIFETIME
GUARANTEE

MERSHIELD
STAYCLEAR

Showerwall

The 8 Series Showerwall is stylish yet functional by design. With its frameless 8mm toughened safety glass, this panel stands at an impressive 2015mm high including rail and is suitable for either a recess with a corner situation. It is guaranteed to make a statement in any bathroom.

features.

- Height 2015mm including rail
- Suitable for wetroom and shower tray application
- Suitable for recess and corner situation
- Reversible

Showerwall					Add a Merlyn MStone Tray			
Size	Tray Finish Adjustment	Order Code	Price £ Exc. VAT	Price £ Inc. VAT	Tray Size	Order Code*	Price £ Exc. VAT	Price £ Inc. VAT
700	670-690	M8SW201	540.18	648.21	1200x900	MS8SW201	746.63	895.96
800	770-790	M8SW211	560.49	672.59	1400x900	MS8SW211	870.49	1044.59
900	870-890	M8SW221	586.78	704.14	1400x900	MS8SW221	896.78	1076.14
1000	970-990	M8SW231	593.96	712.75	1500x900	MS8SW231	947.34	1136.81
1200	1170-1190	M8SW241	626.22	751.46	1680x760	MS8SW241	1045.93	1255.11

*Order code for ordering shower enclosure with tray.

Additional Options				
	Size mm	Order Code	Price £ Exc. VAT	Price £ Inc. VAT
Corner Profile	2000	A04S0003	42.00	50.40

Please Note: We recommend a minimum entry opening of 500mm.

Showerwall

Corner Profile

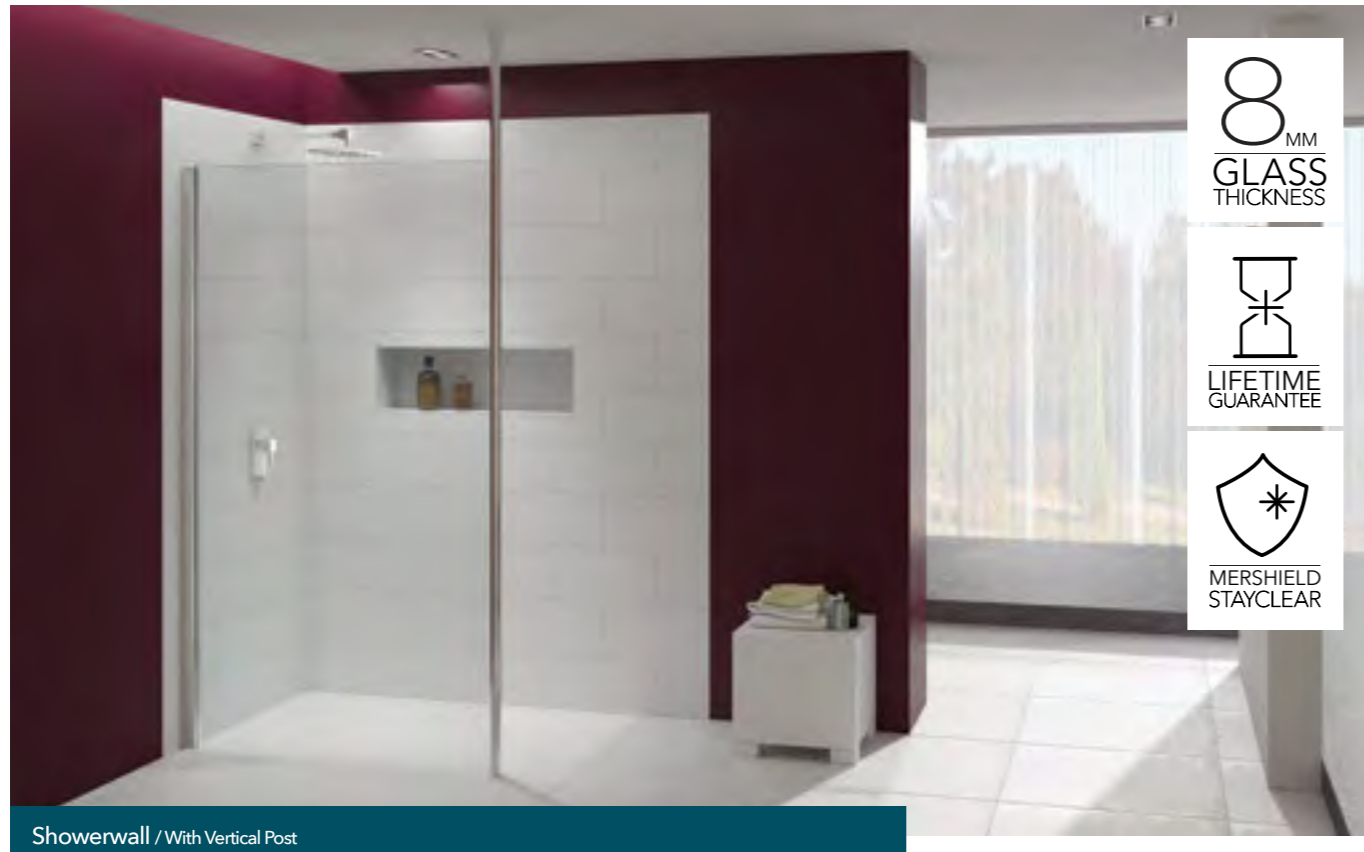

8 MM
GLASS
THICKNESS

LIFETIME
GUARANTEE

MERSHIELD
STAYCLEAR

Showerwall / With Vertical Post

Showerwall - with Vertical Post

The 8 Series Showerwall with Vertical Post is stylish yet functional. The simplicity of a large glass panel creating an elegant walk in shower in your bathroom is not only very practical but the addition of the Vertical Post also brings great height to any space.

features.

- Height 2000mm
- Suitable for wetroom and shower tray application
- 3 meter vertical post can be cut to fit suitable height
- Vertical Post can be retro-fitted to glass thickness of 6mm, 8mm and 10mm
- Suitable for Recess or corner situation
- Reversible

Showerwall with vertical posts					Add a Merlyn MStone Tray				
Size	Vertical Posts	Tray Finish Adjustment	Order Code	Price £ Exc. VAT	Price £ Inc. VAT	Tray Size	Order Code*	Price £ Exc. VAT	Price £ Inc. VAT
700	max 3 meters	695-715	M8SW201H	686.20	823.44	1200x900	M8SW201HB	910.19	1092.22
800	max 3 meters	795-815	M8SW211H	706.52	847.82	1400x900	M8SW211HB	1029.28	1235.14
900	max 3 meters	895-915	M8SW221H	732.80	879.36	1400x900	M8SW221HB	1055.56	1266.67
1000	max 3 meters	995-1015	M8SW231H	739.98	887.98	1500x900	M8SW231HB	1093.36	1312.03
1200	max 3 meters	1195-1215	M8SW241H	772.24	926.69	1680x760	M8SW241HB	1191.95	1430.34

*Order code for ordering shower enclosure with tray.

technical drawing.

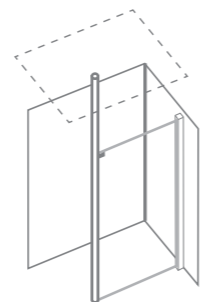

Vertical Pole
Supplied with high level Vertical Post. Post supplied 3 metre maximum length (designed to be adapted to size). Recommended opening min 500mm.

Vertical Post Only for retro fit to existing showerwalls (6mm, 8mm or 10mm)

Vertical Posts	Order Code*	Price £ Exc. VAT	Price £ Inc. VAT
max 3 metres	A0417C0 N	151.86	182.23

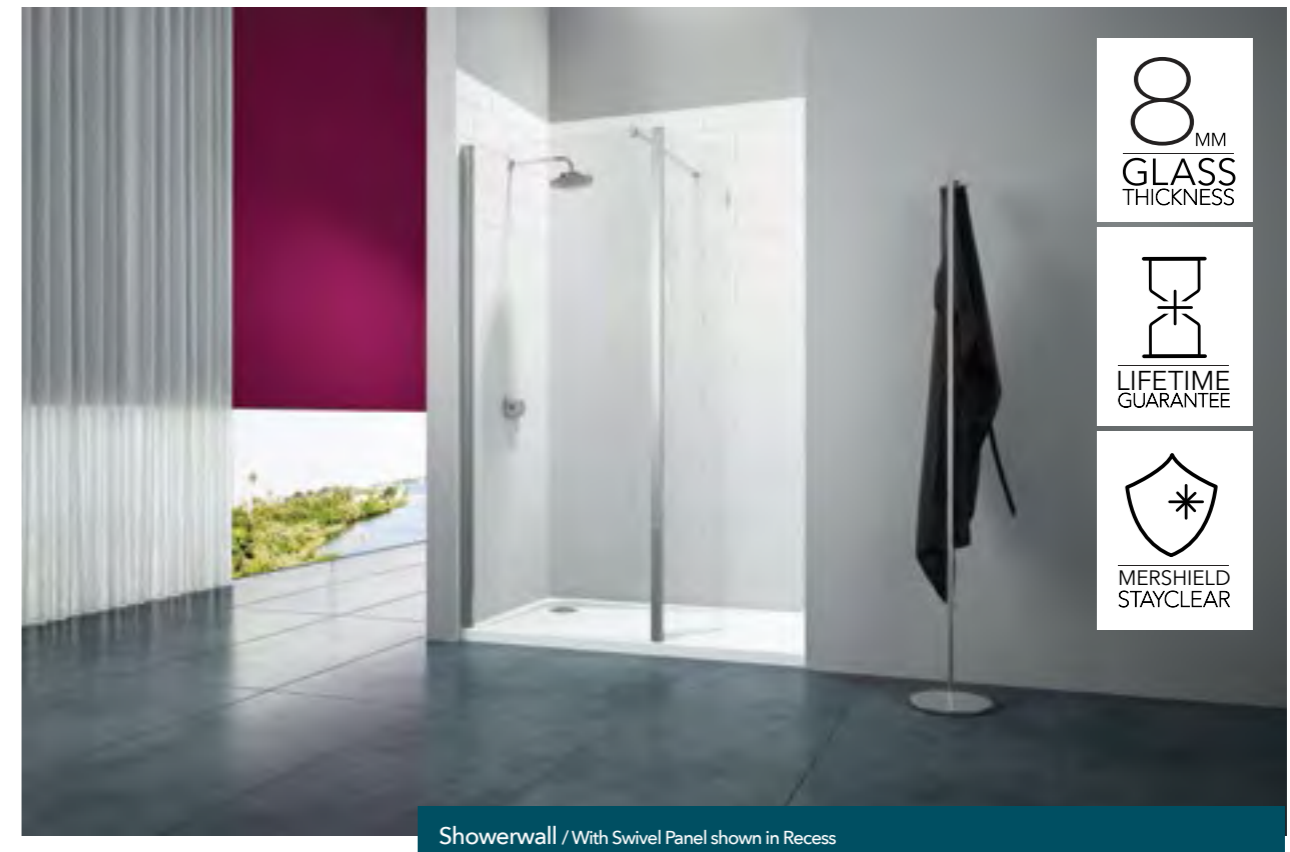

8 MM
GLASS
THICKNESS

LIFETIME
GUARANTEE

MERSHIELD
STAYCLEAR

Showerwall / With Swivel Panel shown in Recess

Showerwall - with Swivel Panel

The 8 Series Showerwall with Swivel Panel is stylish yet functional by design the ingenious 300mm swivel panel can be adjusted to deflect shower-spray.

features.

- Height 2015mm including rail
- Reversible
- Swivel Panel can be adjusted to deflect shower spray
- Suitable for wetroom and shower tray application
- Suitable for recess of corner situation

technical drawing.

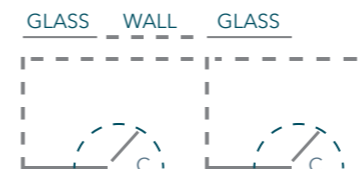

C: Swivel Panel

Radius of Swivel Panel x 350mm.
Recommended opening is 350mm.

Swivel Panel Only for retro fit to existing showerwalls (6mm, 8mm or 10mm)

Swivel Panel Size	Order Code*	Price £ Exc. VAT	Price £ Inc. VAT
300	M8SWS30	255.12	306.14

Showerwall with Swivel Panel					Add a MStone Tray				
Shower-wall	Swivel Panel	Tray Finish Adjustment	Order Code	Price £ Exc. VAT	Price £ Inc. VAT	Tray Size	Order Code*	Price £ Exc. VAT	Price £ Inc. VAT
700	300	670-690	M8SW201SV	629.81	755.57	1200x900	MS8SW201SV	853.80	1024.56
800	300	770-790	M8SW211SV	650.12	780.15	1400x900	MS8SW211SV	972.88	1167.46
900	300	870-890	M8SW221SV	676.41	811.59	1400x900	MS8SW221SV	999.17	1199.00
1000	300	970-990	M8SW231SV	683.59	820.30	1500x900	MS8SW231SV	1036.97	1244.36
1200	300	1170-1190	M8SW241SV	715.85	859.02	1680x760	MS8SW241SV	1135.56	1362.67

*Order code for ordering shower enclosure with tray.



Walk In

Walk In

The 8 Series Walk In is stylish yet functional by design. The simplicity of large glass panels forms a luxurious walk-in shower in your bathroom. It is not only very practical but the ease of walking into your shower with no doors to negotiate needs little explanation.

features.

- Height 2015mm including rail
- Suitable for wetroom and shower tray application
- Reversible

Walk In					Add a Merlyn MStone Tray			
Front Panel	End Panel	Order Code*	Price £ Exc. VAT	Price £ Inc. VAT	Tray Size	Order Code*	Price £ Exc. VAT	Price £ Inc. VAT
700	800	M80243	1100.67	1320.81	1200x800	MS80243	1312.14	1574.57
700	900	M80241	1126.96	1352.35	1200x900	MS80241	1350.95	1624.14
900	800	M80293	1147.27	1376.73	1400x800	MS80293	1457.27	1748.73
					1500x800	MS80263	1470.03	1764.04
900	900	M80291	1173.57	1408.28	1400x900	MS80291	1526.95	1832.34
					1500x900	MS80261	1449.67	1739.61
1000	800	M80273	1154.44	1385.33	1600x800	MS80273	1570.31	1884.38
1000	900	M80271	1180.74	1416.88	1600x900	MS80271	1596.61	1915.94
1200	800	M80281	1186.71	1424.05	1700x800	MS80283	1682.96	2019.55

*Order code for ordering shower enclosure with tray.

technical drawing.

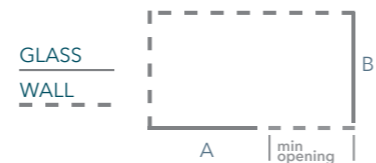

A: Front Panel
B: End Panel

Recommended opening min 500mm

A: Front Panel
B: End Panel

Recommended opening min 500mm



Walk in / With Swivel Panel

Walk In - with Swivel Panel

The 8 Series Walk In with Swivel Panel is stylish yet functional by design - the clever 300mm swivel panel can be adjusted to deflect shower spray.

features.

- Height 2015mm including rail
- Reversible
- Suitable for shower tray application
- Suitable for recess of corner situation

technical drawing.

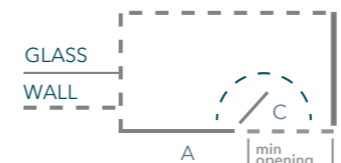

A: Front Panel
B: End Panel
C: Swivel: Panel

Radius Swivel Panel is 350mm.
Recommended opening min 500mm.

Swivel Panel only for retrofit to existing Showerwalls				
Swivel Panel Size	Order Code*	Price £ Exc. VAT	Price £ Inc. VAT	
300	M8SWS30	255.12	306.14	

Walk In						Add a Merlyn MStone Tray			
Front Panel	End Panel	Swivel Panel	Order Code	Price £ Exc. VAT	Price £ Inc. VAT	Tray Size	Order Code*	Price £ Exc. VAT	Price £ Inc. VAT
700	800	300	M80243SV	1190.30	1428.36	1200x800	MS80243SV	1401.77	1682.12
700	900	300	M80241SV	1216.58	1459.90	1200x900	MS80241SV	1440.57	1728.68
900	800	300	M80293SV	1236.90	1484.28	1400x800	MS80293SV	1546.90	1856.28
						1500x800	MS80263SV	1877.20	2252.64
900	900	300	M80291SV	1263.20	1515.84	1400x900	MS80291SV	1590.28	1908.33
						1500x900	MS80261SV	1590.28	1908.33
1000	800	300	M80273SV	1236.90	1484.28	1600x800	MS80273SV	1652.77	1983.33
1000	900	300	M80271SV	1263.20	1515.84	1600x900	MS80271SV	1679.07	2014.89
1200	800	300	M80283SV	1269.59	1523.51	1700x800	MS80283SV	1765.84	2119.01

*Order code for ordering shower enclosure with tray.

SecureSeal.
by MERLYN



The ultimate leak free bath screens

SecureSeal by Merlyn offers functional and easy to use designs to complement any bathroom space. It has been designed with the same unrelenting attention to detail demonstrated across all Merlyn products.

Why choose SecureSeal?

Glass screen heights

With a screen height of 1500mm and glass of 6mm this bath screen offers you great quality together with it's functionality.

Leak free Sealing Arm

Leak Free Sealing arm The leak free sealing arm gives you peace of mind to enjoy a leak free shower experience.

Fixed panel storage option

All sizes within this range of bath screens offer you the choice of adding our Fixed Panel, giving you greater storage and functionality.



Tested for quality & safety

All products are rigorously tested by us and by global health and safety experts to make sure they adhere to the highest quality standards (CE mark info page 109).

Space solutions

With the option of a Single, 4 Fold or 5 Fold, the SecureSeal by Merlyn offers you choice to suit your bathroom space.

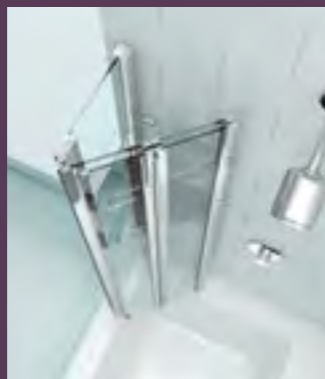

This is the SecureSeal Leak Free Sealing Arm

SecureSeal Lock

SecureSeal
bath screens

How SecureSeal works

The SecureSeal by Merlyn has been designed with a Leak Free Sealing arm which extends from the profile to create a complete seal between the bath and screen. When not in use, the arm simply folds away back into the profile.

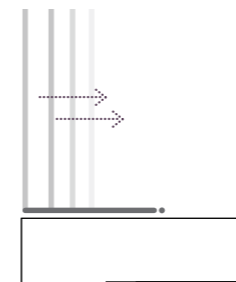

01. Extend
Extend screen and locate panels.

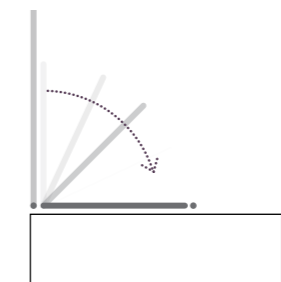

02. Pull Down
Pull down arm from storage position.

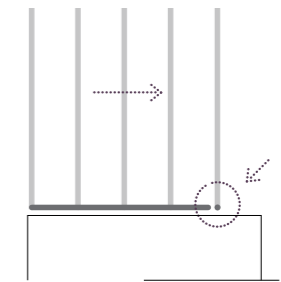

03. Lock In
Fully extend and clip into position for a secure fit and tight seal.

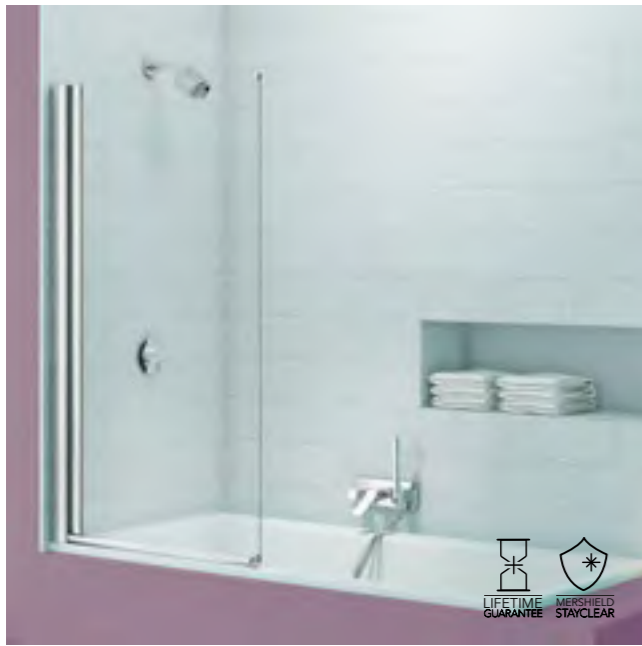

SecureSeal Single Panel

Single Panel				
Size	Adjustment	Order Code	Price £ Exc. VAT	Price £ Inc. VAT
800x1500	780-800	MS1	209.13	250.95



A: Moving Panels (screen width when folded into the bath 712mm)
 Recommended shower head position

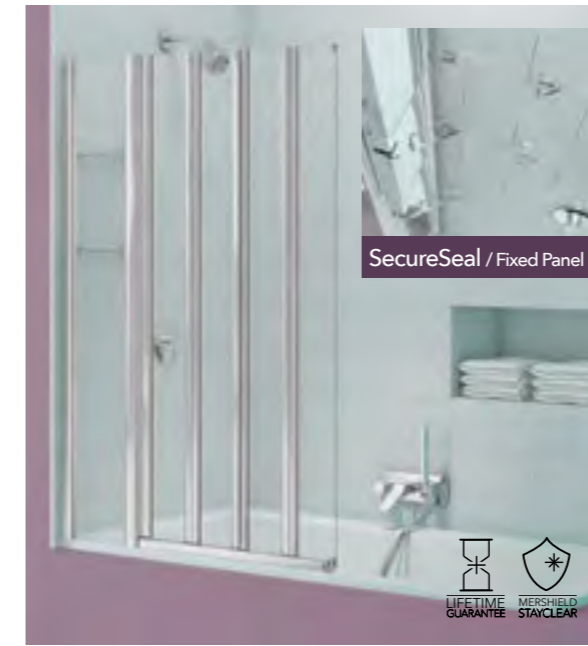

SecureSeal 4 Fold - with Storage

4 Fold with storage				
Size	Adjustment	Order Code	Price £ Exc. VAT	Price £ Inc. VAT
800x1500	780-800	MS4	349.13	418.95

Optional SecureSeal Fixed Panel				
Size	Adjustment	Order Code	Price £ Exc. VAT	Price £ Inc. VAT
300x1500	300-320	MSFP	165.38	198.46



A: Moving Panels (screen width when folded into the bath 228mm) B: Fixed Panel
 Recommended shower head position



SecureSeal Single Panel - with Storage

Single Panel with storage				
Size	Adjustment	Order Code	Price £ Exc. VAT	Price £ Inc. VAT
800x1500	780-800	MS1	209.13	250.95

Optional SecureSeal Fixed Panel				
Size	Adjustment	Order Code	Price £ Exc. VAT	Price £ Inc. VAT
300x1500	300-320	MSFP	165.38	198.46



A: Moving Panels (screen width when folded into the bath 712mm) B: Fixed Panel
 Recommended shower head position



SecureSeal 5 Fold

5 Fold				
Size	Adjustment	Order Code	Price £ Exc. VAT	Price £ Inc. VAT
1000x1500	980-1000	MS5	392.88	471.45



A: Moving Panels (screen width when folded into the bath 228mm)
 Recommended shower head position



SecureSeal 4 Fold

4 Fold				
Size	Adjustment	Order Code	Price £ Exc. VAT	Price £ Inc. VAT
800x1500	780-800	MS4	349.13	418.95



A: Moving Panels (screen width when folded into the bath 228mm)
 Recommended shower head position



SecureSeal 5 Fold - with Storage

5 Fold with storage				
Size	Adjustment	Order Code	Price £ Exc. VAT	Price £ Inc. VAT
1000x1500	980-1000	MS5	392.88	471.45

Optional SecureSeal Fixed Panel				
Size	Adjustment	Order Code	Price £ Exc. VAT	Price £ Inc. VAT
300x1500	300-320	MSFP	165.38	198.46



A: Moving Panels (screen width when folded into the bath 228mm) B: Fixed Panel
 Recommended shower head position



Bath Screens



Bath Screens

Innovative design and contemporary aesthetics bring this bathroom favourite to life. This modern collection has been created with the same superb materials and unrelenting attention to detail demonstrated across all Merlyn ranges.

Why choose Merlyn Bath Screens?

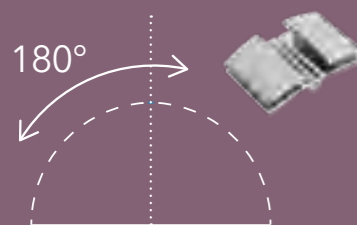

180° inwards swing
The signature piece of this range, the Two Panel Hinged Bath Screen features a secure 180° inwards swing which means you can position the glass where you can comfortably deflect water into the bath and not on to the floor!

Tested for quality & safety

All products are rigorously tested by us and by global health and safety experts to make sure they adhere to the highest quality standards (CE mark info page 109).

Rise and fall

All Merlyn Bath Screens have a rise and fall hinge to make it easier for you to open.

Product Information

- Merlyn Bath Screens are not designed to fit on baths with stepped fronts, roll top rims or integral soap dishes.
- Fitting of screen on baths which have raised head rests or shapes is not recommended.
- There must be no items causing obstruction with the seal and bath, as any of the above may cause leaks.
- When choosing your Bath Screen, please ensure that if your bath has bath handles and that they do not interfere with the bath rim area where your screen will be placed.
- When choosing an in-swing or folding Bath Screen, please ensure your swing area is not interfering with any brassware or internal shower features. Similarly, when choosing an out-swing, please ensure the out-swing area is free from any obstructions.
- The Merlyn MB7 2 Panel Hinged Bath Screen is handed so please ensure you state whether you require a right or left handed configuration when ordering.
- It is recommended that the shower head position is situated on the same wall to which the Bath Screen is fixed and in the centre of the shower area.

Cleaning

- It is important to clean your Merlyn Bath Screen after every use. Wipe down all the glass and metal parts with a soft cloth.
- Do not allow limescale to build up in hard water areas.
- Ensure that any residual water on the glass is removed after every use.
- Clean the glass regularly using soapy water.
- Do not use abrasive products on any surfaces.

12 Bath Screens to choose from

Whether you are looking for a fresh modern angular style shower screen or a minimalist curved frameless screen, we have a great choice of styles, panel options, open and close features in this range of Merlyn Bath Screens.

Great space saving features

Featuring both design and functionality the 2 Panel Curved Bath Screen is the ultimate in space efficiency. With a sleek chrome towel rail and fitted internal shelves, this piece combines style with purpose for in bath showering.

HydraSEAL

Merlyn have created an exciting new feature called HydraSEAL, which has been added to 5 of our featured bath screens. HydraSEAL acts as an extra barrier to reduce water escaping from your bath screen during your showering experience. HydraSEAL is available on our MB1, MB2, MB3A, MB3B and MB3 bath screens.



Bath Screens

Please see page 106 for important tray information.

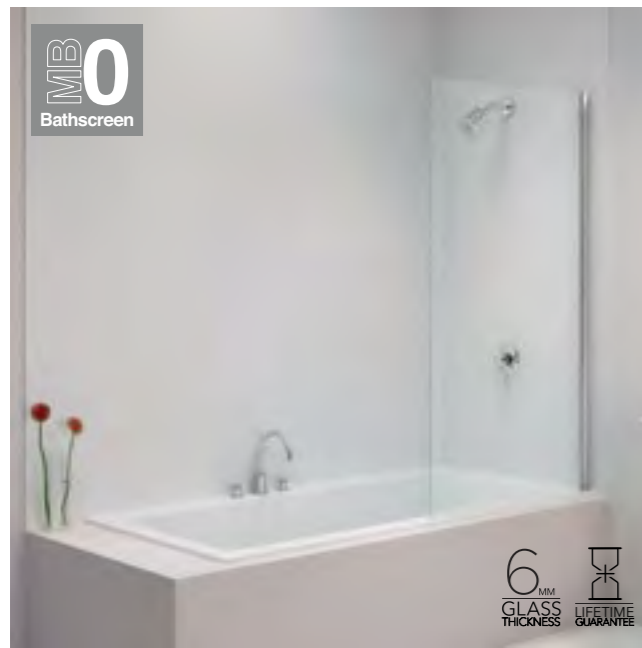

Fixed Square

Fixed Square				
Size	Panel	Order Code	Price £ Exc. VAT	Price £ Inc. VAT
800x1500	1	MB0	108.60	130.32

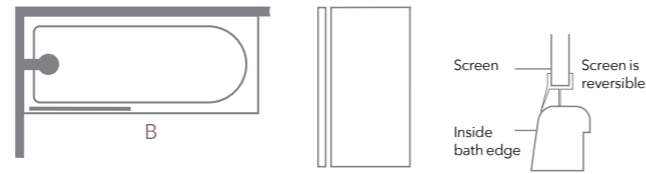

Please ensure product is fitted with moving panel seals in line with bath inside edge.

○ Recommended shower head position

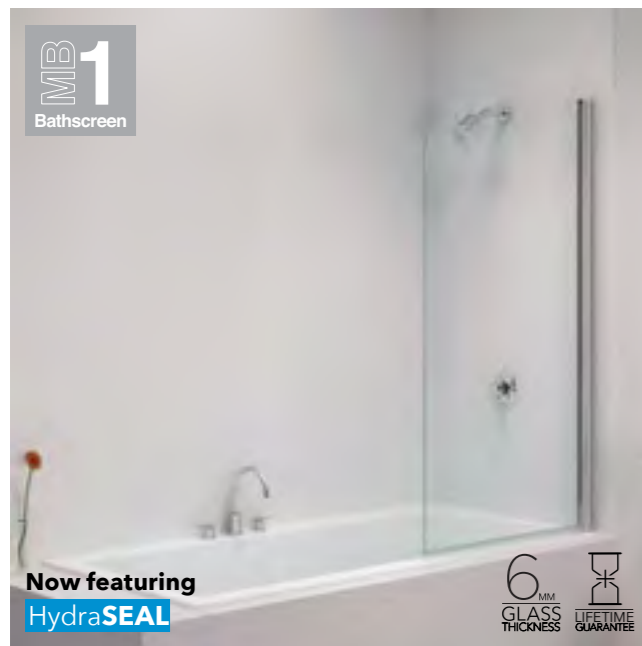

Single Curved

Single Curved				
Size	Panel	Order Code	Price £ Exc. VAT	Price £ Inc. VAT
800x1500	1	MB1	148.23	177.88



Please ensure product is fitted with moving panel seals in line with bath inside edge.

Door Swing: 90° in and out
B: Radius of Screen Swing = 733mm

○ Recommended shower head position



Single Square

Single Square				
Size	Panel	Order Code	Price £ Exc. VAT	Price £ Inc. VAT
800x1500	1	MB2	175.33	210.40



Please ensure product is fitted with moving panel seals in line with bath inside edge.

Door Swing: 90° in and out
B: Radius of Screen Swing = 733mm

○ Recommended shower head position

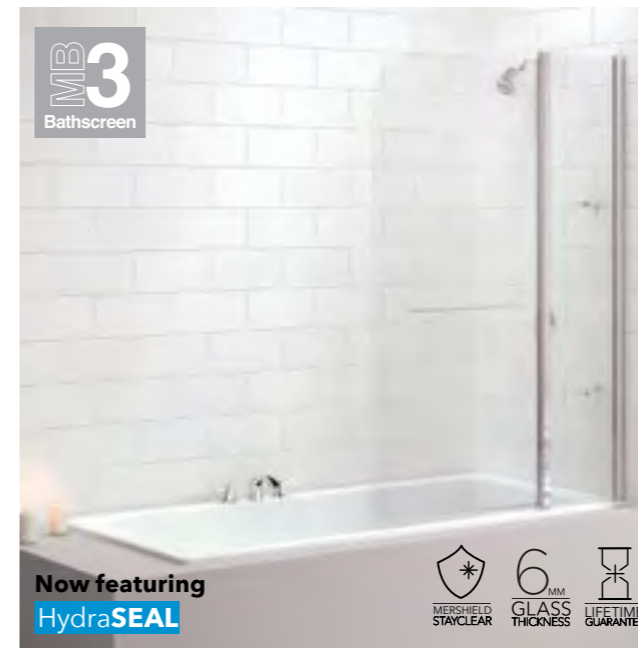

2 Panel Curved

2 Panel Curved				
Size	Panel	Order Code	Price £ Exc. VAT	Price £ Inc. VAT
1150x1500	2	MB3	414.29	497.15



Please ensure product is fitted with moving panel seals in line with bath inside edge.

Door Swing: 90° in and out
A: Fixed Panel B: Radius of Screen Swing = 733mm

○ Recommended shower head position

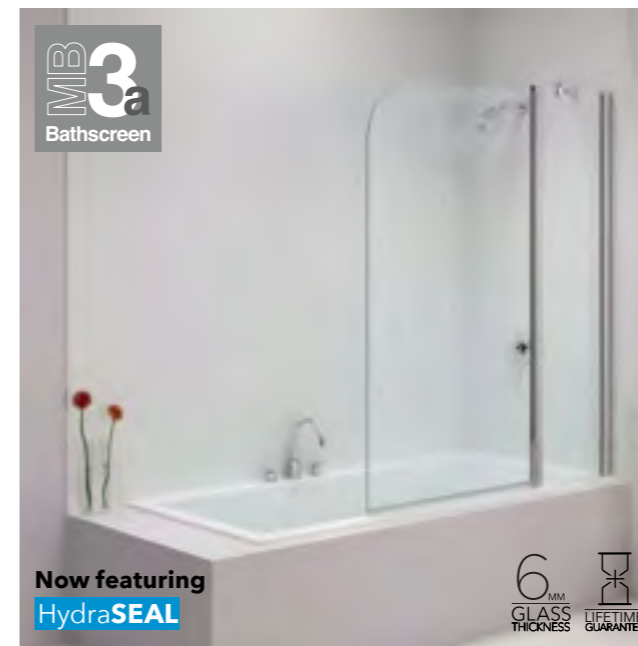

2 Panel Folding Curved

2 Panel Folding Curved				
Size	Panel	Order Code	Price £ Exc. VAT	Price £ Inc. VAT
900x1500	2	MB3A	244.90	293.88



Please ensure product is fitted with moving panel seals in line with bath inside edge.

Door Swing: 90° in and out
A: Fixed Panel B: Radius of Screen Swing = 483mm

○ Recommended shower head position

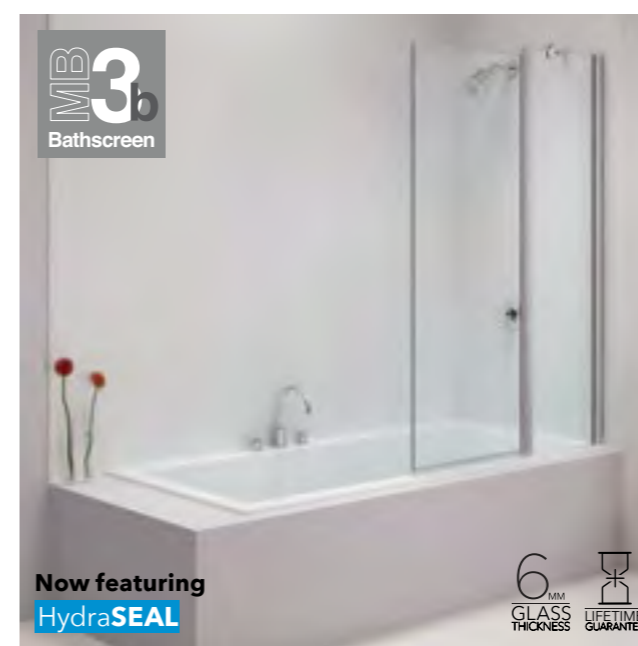

2 Panel Folding Square

2 Panel Folding Square				
Size	Panel	Order Code	Price £ Exc. VAT	Price £ Inc. VAT
900x1500	2	MB3B	244.90	293.88



Please ensure product is fitted with moving panel seals in line with bath inside edge.

Door Swing: 90° in and out
A: Fixed Panel B: Radius of Screen Swing = 483mm

○ Recommended shower head position



Bath Screens



4 Fold

4 Fold				
Size	Panel	Order Code	Price £ Exc. VAT	Price £ Inc. VAT
850x1400	4	MB4	290.93	349.12

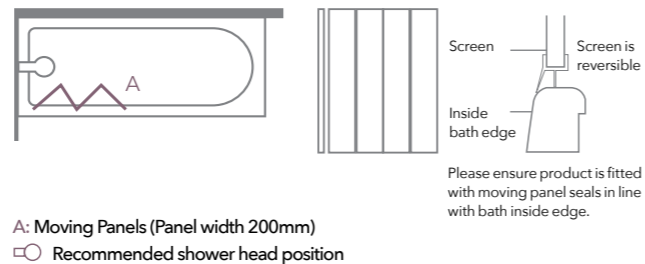

2 Panel Hinged

2 Panel Hinged				
Size	Panel	Order Code	Price £ Exc. VAT	Price £ Inc. VAT
900x1500	2	MB7L (Left handed)	475.03	570.04
900x1500	2	MB7R (Right handed)	475.03	570.04

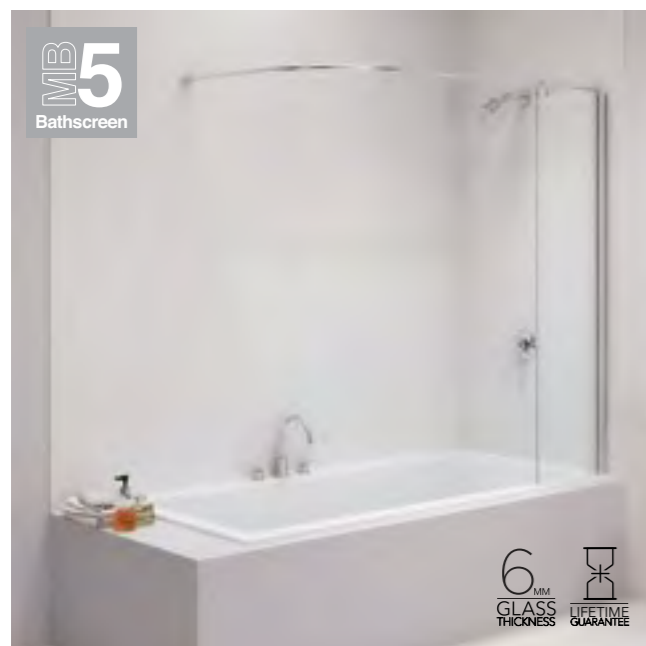
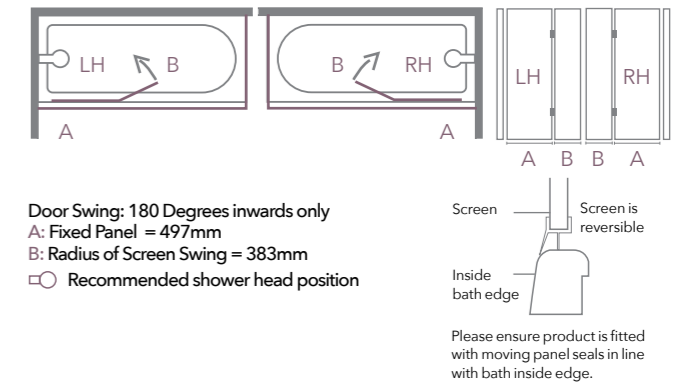

Curtain Rail

Curtain Rail				
Size	Panel	Order Code	Price £ Exc. VAT	Price £ Inc. VAT
300x1500	1	MB5	194.93	233.92

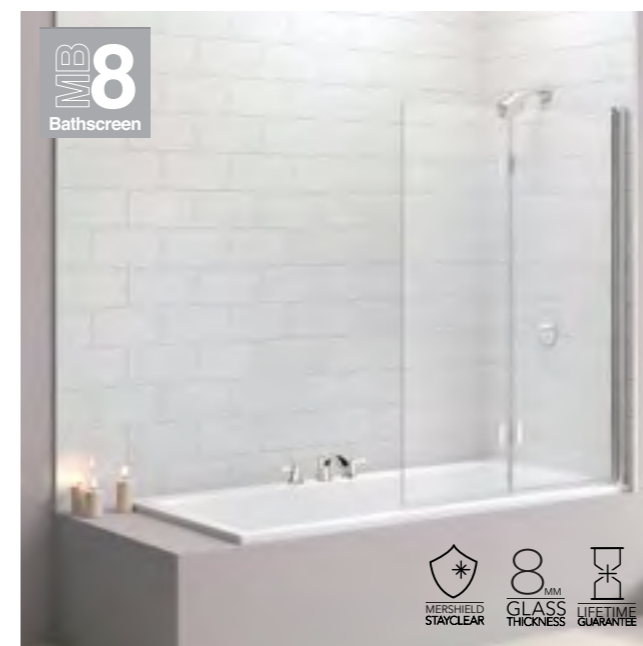
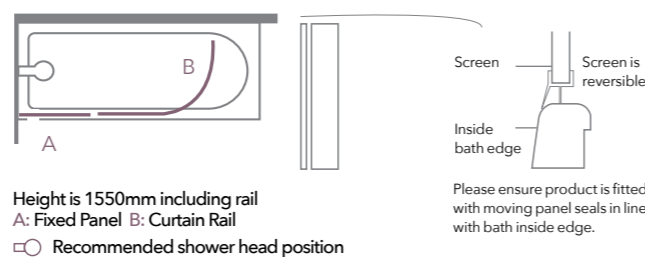

2 Panel Folding

2 Panel Folding				
Size	Panel	Order Code	Price £ Exc. VAT	Price £ Inc. VAT
1100x1500	2	MB8	472.37	566.84

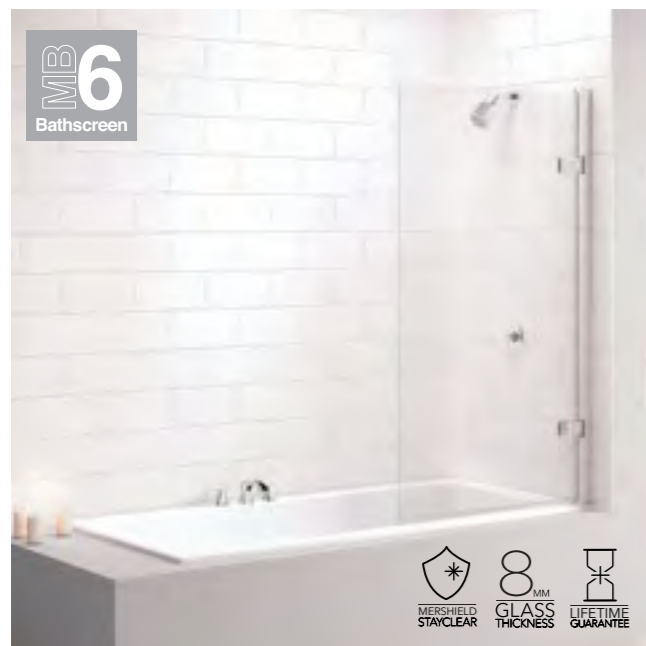
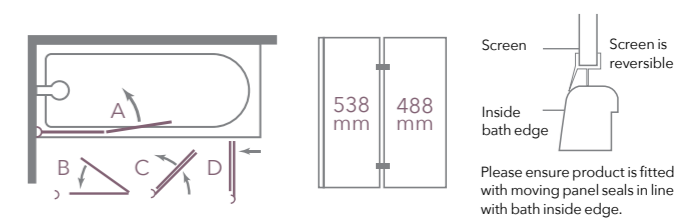

Hinged Square

Hinged Square				
Size	Panel	Order Code	Price £ Exc. VAT	Price £ Inc. VAT
850x1500	1	MB6	389.70	467.64

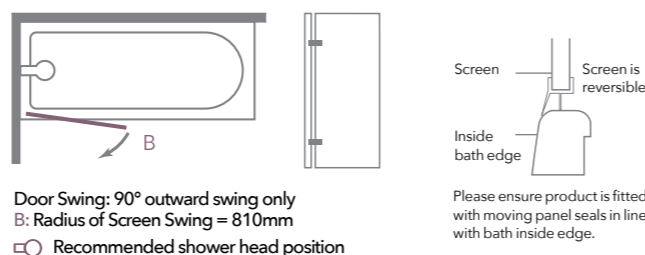

3 Panel Folding

3 Panel Folding				
Size	Panel	Order Code	Price £ Exc. VAT	Price £ Inc. VAT
1400x1500	3	MB9	590.75	708.90

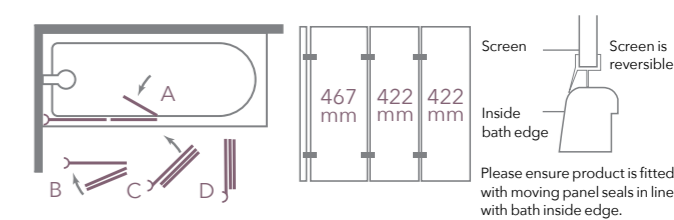

TRUESTONE®

Luxurious textured slate trays

Beautifully handcrafted and ultra-low slate trays, elegant in appearance and luxurious to touch. With 3 finishes to choose from - White, Slate Black and Fossil Grey. These trays will bring an element of natural beauty and a truly designer finish to your bathroom.

Why choose TrueStone Trays?



Slate Black TrueStone Tray

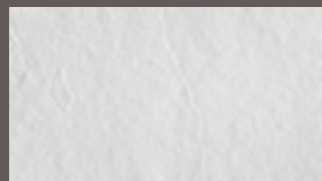

White



Slate Black



White TrueStone Tray

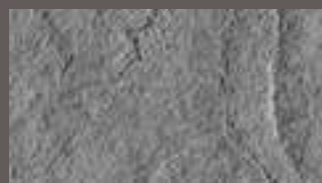

Fossil Grey



Fossil Grey TrueStone tray



Ultra slim tray 30mm



Branded waste cover



White TrueStone Tray

Feature Highlights

- Ultra slim: Only 30mm in height
- Handcrafted from High grade stone resin
- 3 colour options - White and Slate Black & Fossil Grey
- Integrated discreet waste
- Luxurious textured finish
- Can be fitted on or level with floor
- Comes with 90mm fast flow waste

Rectangular Tray

Rectangular Tray (comes with Merlyn 90mm fast flow waste)

Size	Colour	Order Code	Price £ Exc. VAT	Price £ Inc. VAT
1000x800	Slate Black	T108RTG	450.88	541.06
1000x800	White	T108RTW	450.88	541.06
1000x800	Fossil Grey	T108RTF	450.88	541.06
1200x800	Slate Black	T128RTG	534.16	640.99
1200x800	White	T128RTW	534.16	640.99
1200x800	Fossil Grey	T128RTF	534.16	640.99
1200x900	Slate Black	T129RTG	599.92	719.90
1200x900	White	T129RTW	599.92	719.90
1200x900	Fossil Grey	T129RTF	599.92	719.90
1400x800	Slate Black	T148RTG	593.64	712.37
1400x800	White	T148RTW	593.64	712.37
1400x800	Fossil Grey	T148RTF	593.64	712.37
1400x900	Slate Black	T149RTG	653.12	783.74
1400x900	White	T149RTW	653.12	783.74
1400x900	Fossil Grey	T149RTF	653.12	783.74
1500x800	Slate Black	T158RTG	628.13	753.76
1500x800	White	T158RTW	628.13	753.76

Rectangular Tray continued...

Size	Colour	Order Code	Price £ Exc. VAT	Price £ Inc. VAT
1500x800	Fossil Grey	T158RTF	628.13	753.76
1500x900	Slate Black	T159RTG	799.45	959.34
1500x900	White	T159RTW	799.45	959.34
1500x900	Fossil Grey	T159RTF	799.45	959.34
1600x800	Slate Black	T168RTG	670.96	805.15
1600x800	White	T168RTW	670.96	805.15
1600x800	Fossil Grey	T168RTF	670.96	805.15
1600x900	Slate Black	T169RTG	866.06	1039.27
1600x900	White	T169RTW	866.06	1039.27
1600x900	Fossil Grey	T169RTF	866.06	1039.27
1700x800	Slate Black	T178RTG	736.40	883.68
1700x800	White	T178RTW	736.40	883.68
1700x800	Fossil Grey	T178RTF	736.40	883.68
1700x900	Slate Black	T179RTG	894.62	1073.54
1700x900	White	T179RTW	894.62	1073.54
1700x900	Fossil Grey	T179RTF	894.62	1073.54

Please see page 106 for important tray information.

Please ensure that the shower head is not positioned directly over the waste as this may restrict flow rate.

TrueStone
trays



TRUESTONE®

Square Tray

Square Tray (comes with Merlyn 90mm fast flow waste)

Size	Colour	Order Code	Price £ Exc. VAT	Price £ Inc. VAT
900x900	Slate Black	T90RTG	424.70	509.64
900x900	White	T90RTW	474.67	569.60
900x900	Fossil Grey	T900F	474.67	569.60

TRUESTONE®

Quadrant Tray

Quadrant Tray (comes with Merlyn 90mm fast flow waste)

Size	Colour	Order Code	Price £ Exc. VAT	Price £ Inc. VAT
900x900	Slate Black	T90QG	424.70	509.64
900x900	White	T90QW	424.70	509.64
900x900	Fossil Grey	T900F	424.70	509.64

TRUESTONE®

Offset Quadrant Tray

Offset Quadrant Tray (comes with Merlyn 90mm fast flow waste)

Size	Colour	Order Code	Price £ Exc. VAT	Price £ Inc. VAT
1200x900	Slate Black	T129HG L or R	653.12	783.74
1200x900	White	T129HW L or R	653.12	783.74
1200x900	Fossil Grey	T129HW L or R	653.12	783.74

This product is handed please choose L for left and R for right when ordering.



Left Handed (L) Right Handed (R)

Please see page 106 for important tray information.

Sleek minimalist design

This tray is sleek and ultra slim, creating a modern and contemporary feel for any bathroom. At only 25mm high this tray can be fitted flush to the floor encompassing all the benefits of a wetroom floor and accessibility but without the costly wetroom installation. The discreet integrated waste cover ensures it is aesthetically pleasing to the eye but highly functional.

Level25 Trays

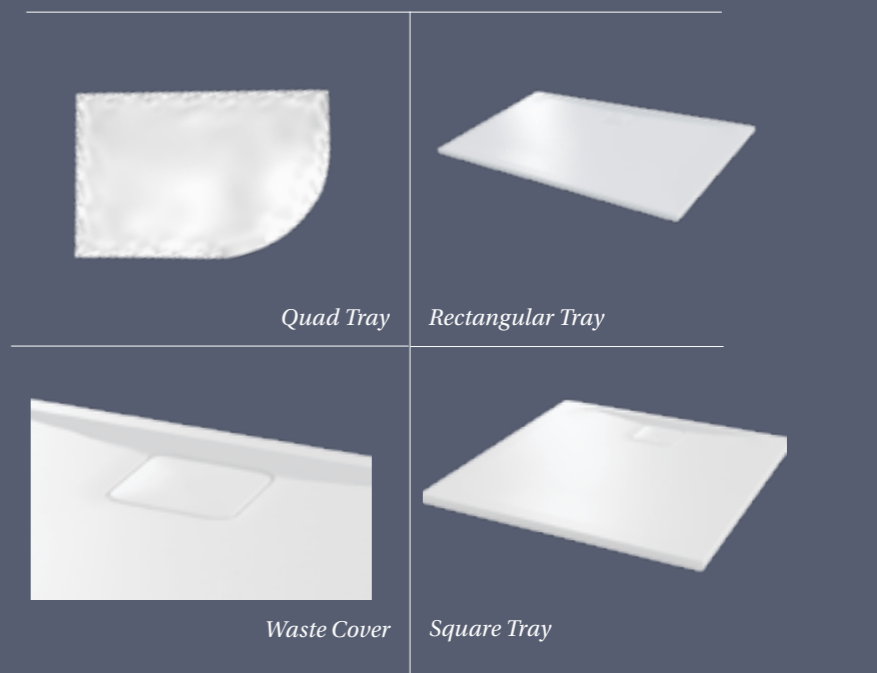

Feature Highlights

- Ultra slim 25mm low level tray
- Sleek minimalist design
- Discreet integrated waste cover
- Can be fitted on or level with floor
- Comes with 90mm fast flow waste
- Shower tray 25 year guarantee
- Available in square, rectangular and quadrant

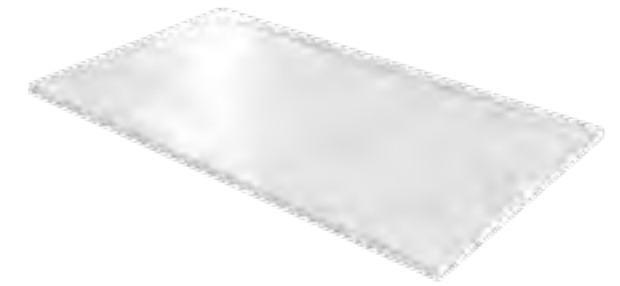

LEVEL25[®]
Square Tray

Square Tray (comes with Merlyn 90mm fast flow waste)

Size	Order Code	Price £ Exc. VAT	Price £ Inc. VAT
900x900	L90SQ	246.05	295.26



Waste Cover

Note: Please ensure that the shower head is not positioned directly over the waste as this may restrict water flow rate.



LEVEL25[®]
Rectangular Tray

Rectangular Tray (comes with Merlyn 90mm fast flow waste)

Size	Order Code	Price £ Exc. VAT	Price £ Inc. VAT
1000x800	L108RT	246.05	295.26
1000x900	L109RT	268.52	322.22
1100x800	L118RT	268.52	322.22
1100x900	L119RT	268.52	322.22
1200x800	L128RT	268.52	322.22
1200x900	L129RT	279.75	335.70
1300x800	L138RT	399.93	479.92
1300x900	L139RT	399.93	479.92
1400x800	L148RT	399.93	479.92
1400x900	L149RT	399.93	479.92
1500x800	L158RT	430.30	516.36
1500x900	L159RT	430.30	516.36
1600x800	L168RT	448.28	537.94
1600x900	L169RT	448.28	537.94
1700x800	L178RT	510.07	612.08
1700x900	L179RT	513.44	616.13

LEVEL25[®]
Quadrant Tray

Square Tray (comes with Merlyn 90mm fast flow waste)

Size	Order Code	Price £ Exc. VAT	Price £ Inc. VAT
900x900	L90Q	287.83	345.40

LEVEL25[®]
Offset Quadrant Tray

Square Tray (comes with Merlyn 90mm fast flow waste)

Size	Order Code	Price £ Exc. VAT	Price £ Inc. VAT
1200x900	L129QL	394.83	473.80
1200x900	L129QR	394.83	473.80

Please see page 106 for important tray information.

MSTONE



Function with style

The MStone double skin stone resin tray is sleek and sophisticated in design. A highly engineered tray providing rigidity and strength, combined with a relatively low weight. MStone trays are ideal for 'low level' installation. Alternatively, you can raise your tray. In such cases you will need the MStone shower tray panel kit. MStone panel kits are available separately.

Why choose MStone Trays?



Fast flow waste

90mm fast flow waste, includes hair trap and chrome cover.



Adjustable leg system

Graduated adjustable leg system. Bottom acrylic capped ABS layer.



Easy fit tray panel

Graduated adjustable leg and easy fit tray panel kit.



MStone Tray

1. Top Acrylic capped ABS layer
2. Stone Resin
3. Bottom ABS layer (encapsulates the tray)



Feature Highlights

- Double skinned for added rigidity
- 50mm high to achieve minimalist design
- 130mm high including tray panel set
- ABS capped acrylic sheets which has anti-bacterial properties
- Comes with 90mm fast flow waste
- More than 30 sizes available
- Available as low level or with tray panel kits for easy installation
- Shower tray Lifetime Guarantee*

*This guarantee covers manufacturing defects only.

Rectangular Tray

Rectangular Tray (comes with Merlyn 90mm fast flow waste)

Size	Tray Panel Kit (Order Separately)	Order Code	Price £ Exc. VAT	Price £ Inc. VAT
900x760	Kit 4	D976RT D976RT	173.94	208.73
1000x800	Kit 4	D108RT	196.46	235.75
1100x760	Kit 4	D1176RT	220.23	264.28
1100x800	Kit 4	D118RT	208.97	250.76
1200x700	Kit 4	D127RT	206.45	247.74
1200x760	Kit 4	D1276RT	206.45	247.74
1200x800	Kit 4	D128RT	211.47	253.76
1200x900	Kit 4	D129RT	223.99	268.79
1400x800	Kit 3	D148RT	310.00	372.00
1400x900	Kit 3	D149RT	322.76	387.31
1500x700	Kit 3	D157RT	353.38	424.06
1500x800	Kit 3	D158RT	353.38	424.06
1500x900	Kit 3	D159RT	353.38	424.06
1600x800	Kit 3	D168RT	415.87	499.04
1600x900	Kit 3	D169RT	415.87	499.04
1685x700	Kit 3	D1776RT	419.71	503.65
1700x760	Kit 3	D1776RT	419.71	503.65
1700x800	Kit 3	D178RT	496.25	595.50

Tray Panel Kit (including Legs)

1700x700	Kit 3	DRK3	85.07	102.08
1700x760	Kit 4	DRK4	85.07	102.08

Please see page 106 for important tray information.



Waste is centered for 1700 x 800 tray - D178RT

MStone trays



MSTONE

Square Tray

Square Tray (comes with Merlyn 90mm fast flow waste)

Size	Tray Panel Kit (Order Separately)	Order Code	Price £ Exc. VAT	Price £ Inc. VAT
760	Kit 4	D76SQ	111.36	133.63
800	Kit 4	D80SQ	123.88	148.66
900	Kit 4	D90SQ	173.94	208.73

Tray Panel Kit (including Legs)

Kit 4	DRK4	85.07	102.08
-------	------	-------	--------

MSTONE

Quadrant Tray

Quadrant Tray (comes with Merlyn 90mm fast flow waste)

Size	Tray Panel Kit (Order Separately)	Order Code	Price £ Exc. VAT	Price £ Inc. VAT
800	Kit 2	D80Q	158.92	190.70
900	Kit 2	D90Q	173.94	208.73
1000	Kit 5	D100Q	226.95	272.34

Tray Panel Kit (including Legs)

Kit 2	DRK2	85.07	102.08
Kit 5	DRK5	85.07	102.08

MSTONE

Offset Quadrant Tray

Offset Quadrant Tray (comes with Merlyn 90mm fast flow waste)

Size	Tray Panel Kit (Order Separately)	Order Code	Price £ Exc. VAT	Price £ Inc. VAT
900 X 760	Kit 1	D976QL	236.50	283.80
900 X 760	Kit 1	D976QR	236.50	283.80
1000 X 800	Kit 1	D108QL	223.99	268.79
1000 X 800	Kit 1	D108QR	223.99	268.79
1200 X 800	Kit 1	D128QL	235.23	282.28
1200 X 800	Kit 1	D128QR	235.23	282.28
1200 X 900	Kit 1	D129QL	247.76	297.31
1200 X 900	Kit 1	D129QR	247.76	297.31

Tray Panel Kit (including Legs)

Kit 1	DRK1	85.07	102.08
-------	------	-------	--------

Waste Complete

DWAS	20.00	24.00
------	-------	-------

Image above shown as Left Handed (L)
Please choose L for Left or R for Right when ordering.



Left Handed (L)

Right Handed (R)

Please see page 106 for important tray information.

Merlyn shower wiper

Introducing the Merlyn shower wiper to help you keep your enclosure sparkling for years to come. Includes a designer chrome branded holder to keep it within your reach.

Order Code	Price £ Exc. VAT	Price £ Exc. VAT
MG201WIPER	37.42	44.90



Merlyn glass shelf

Order Code	Price £ Exc. VAT	Price £ Exc. VAT
DWHSHELF	86.82	104.19

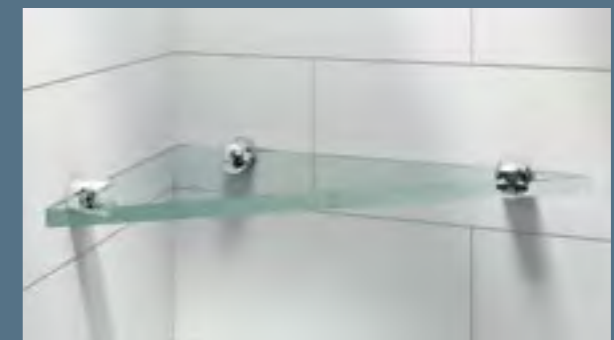

www.merlynshowering.com

Product Information

We have produced this product section to help you with your purchasing decision. For further information please contact your local stockist, details of which can be found at www.merlynshowering.com

Product information

All products are manufactured in accordance with EN14428 and utilise toughened safety glass to EN 12150.

All shower trays are manufactured in accordance with EN14428.

All doors feature adjustable wall profiles to compensate for out-of-true walls and have micro adjustment features for fine tuning to obtain a perfect fit and operating action.

All enclosures, wetrooms and panels are Power Shower approved - will retain water under normal showering conditions.

Water retention is maintained in all products under normal showering conditions.

A selection of Merlyn enclosures are frameless in design. Spray/mist may escape therefore we would recommend use of these enclosures with tiled floors.

Opened cartons can not be returned. Returns carry a €40 box charge or €60 per unit where the sale is less than 30 days old. Returns over 30 days old will not be accepted.

All products are supplied complete with full installation instructions and the necessary fixings.

Check with your dealer for accurate matching of material samples. Product descriptions do not imply the use of precious or valuable materials.

Our policy of reviewing product design and development on a regular basis means Merlyn reserve the right to change product specifications and prices without notice.

Only shower enclosures, panels, MStone shower trays and bath screens are covered by the Lifetime Guarantee. Please contact the Merlyn sales team for more details.

Glass shattering and parts subject to wear are not covered by the Lifetime Guarantee.

For full details on all product ranges please contact Merlyn Showering on 0808 1011429 or log onto www.merlynshowering.com.

Trays shown in this catalogue are for illustrative purposes only.

Images are for illustration purposes only. The colours and finishes shown in the catalogue are as accurate as possible within the limits of the printing process. The positioning of all showering heads in the brochure is for illustrative purposes only.

All descriptions, specifications and particulars contained in this brochure are intended merely to represent a general idea of the products described herein and none of these form part of any contract to give rise to any independent or collateral liability upon the company.

Cleaning

- It is important to clean your Merlyn shower door and tray after every use. Wipe down all the glass and metal parts with a soft cloth.
- Do not allow lime scale to build up in hard water areas.
- Ensure that any residual water on the glass is removed after every use.
- Clean the glass regularly using soapy water.
- Do not use abrasive products on any surfaces.
- Install the enclosure in a well ventilated area.
- For more information on Mersfield Stayclear glass please see page 08 of this brochure.

Information and maintenance

Always read the instructions on the packaging, chrome is vulnerable to acid attack and some strong household cleaners including strong disinfectants, denture cleaners, hair dyes, wine making chemicals and photographic chemicals may contain acid. These materials may have a varying effect on the surface from black spots/streaks (which cannot be removed) to pitting the surface. Contact with these materials should be avoided.

Important shower tray information

- It is up to the designer or installer to ensure that the tray and enclosure combination is arranged in such a way that water retention meets the customers needs.
- The waste has the capacity to carry away 29L/Min. High powered systems may exceed this. Please check with the manufacturer.
- Please ensure that the shower head is not positioned directly over the waste as this may restrict water flow rate.
- Please ensure that the colour and size of shower tray are as per your order before installation.
- You must inspect the product thoroughly before installation. Fitting the product is acceptance of quality.
- The trays are handmade from natural material. Please allow for height variances due to manufacturing tolerances.
- For open ended shower screens please consult your installer.
- Shower trays must be fitted as per the fitting instruction. Deviation from the pre installation checks or fitting installation will void the guarantee.

Important

Although shower door and enclosure sizes are related to tray sizes it is important to note that most shower trays are tiled down to the rim, often over an 'up-stand'. The finished installation space may be less than the nominal tray size. Merlyn shower units are made to suit this remaining space.

Tray Finish min-max

The Tray Finish applies when fitting a door and a tray. These are the minimum and maximum dimensions that a shower door or enclosure will fit using standard wall profiles.

Tray finish

To find the correct Tray Finish dimension:
In a recess: Measure from the finished, tiled wall to the opposite finished, tiled wall.

In a corner: Measure from the finished, tiled wall to the edge of the tray.

Note: If the wall/walls are leaning in, this will further reduce your Tray Finish.

Adjustment

This is the min and max adjustment of the actual enclosure. These are the adjustment dimensions of the actual door excluding the tray. Therefore, these are the dimensions to follow when installing a enclosure in a wetroom application without a tray.

The guide below may be helpful in taking measurements to determine the shower door or enclosure size required. Dimensions given in this publication are in millimetres, are approximate and may vary with adjustment. They are subject to change without notice.

Please note that when a tray is fitted it is essential that the tray is level before any doors or enclosures are fitted.

Recess Location

Take the measurements after the tray is installed and the walls are tiled.

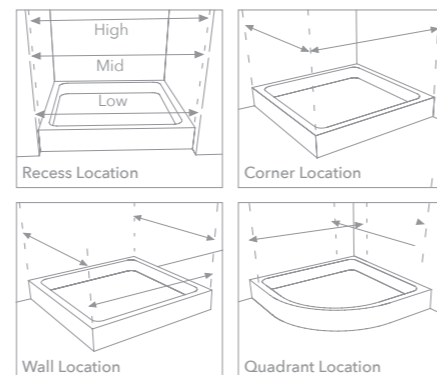

Extension Profiles

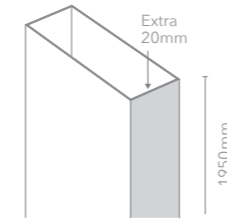

10 Series Sliding Door

Order Code	Height	Price £ Exc. VAT	Price £ Inc. VAT
M108EXTSL	1950	79.81	95.77

Series 10 extension profile: extra 20mm.
Sliding Door can only be used with one extension profile.

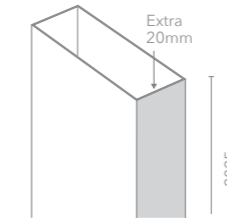

10 Series Pivot - Hinged Side

Order Code	Height	Price £ Exc. VAT	Price £ Inc. VAT
M108EXTPVH	2025	79.81	95.77

Series 10 extension profile: extra 20mm.
Series 10 Pivot Hinge Side extension to be fitted on the same side as the door hinge.

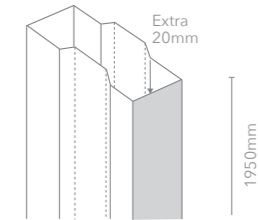

8 Series

Order Code	Height	Price £ Exc. VAT	Price £ Inc. VAT
M8EXT20	1950	60.95	64.61

Series 8 extension profile: extra 20mm.

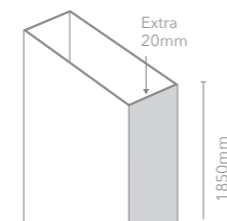

10 Series Quadrant

Order Code	Height	Price £ Exc. VAT	Price £ Inc. VAT
M108EXTQU	1850	79.81	95.77

Series 10 extension profile: extra 20mm.

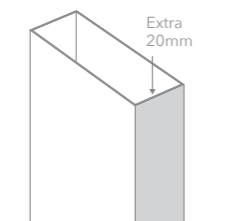

8 Series Frameless - Hinge and Quadrant Doors

Order Code	Height	Price £ Exc. VAT	Price £ Inc. VAT
A0614A0	2000	65.72	78.86

8 Series Frameless extension profile: extra 20mm.

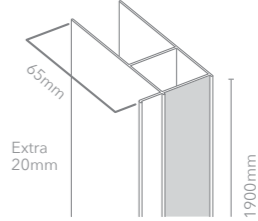

6 Series

Order Code	Height	Price £ Exc. VAT	Price £ Inc. VAT
M6EXT	1900	56.10	67.32

Series 6 extension profile: extra 20mm.
No extension profile available for: Showerwall.

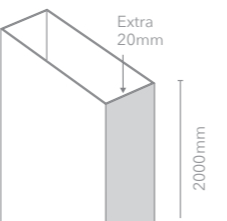

10 Series Pivot

Order Code	Height	Price £ Exc. VAT	Price £ Inc. VAT
M108EXTPV	2000	79.81	95.77

Series 10 extension profile: extra 20mm.
Series 10 Pivot Hinge Side extension should not be fitted on the same side as the door hinge.

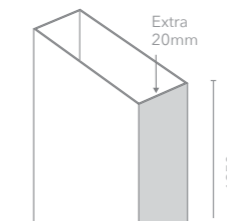

8 Series Frameless - Hinged Bifold Door

Order Code	Height	Price £ Exc. VAT	Price £ Inc. VAT
M8FBEXT20	1950	62.26	74.71

8 Series Frameless extension profile: extra 20mm.

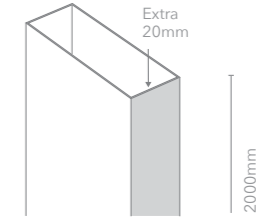

6 Series Frameless

Order Code	Height	Price £ Exc. VAT	Price £ Inc. VAT
S6FEXT	2000	59.74	71.69

6 Series Frameless extension profile: extra 20mm.

Product Information

Waste Positions

TrueStone Trays

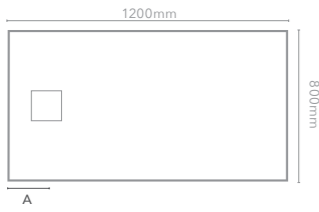

Size	Waste Position (A)	Waste Position (B)
1000x800	270	400
1200x800	250	400
1200x900	250	450
1400x800	350	400
1400x900	350	450
1500x800	400	400
1500x900	400	450
1600x800	450	400
1600x900	450	450
1700x800	500	400
1700x900	500	450

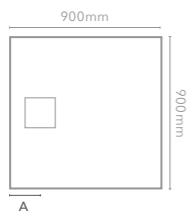

Size	Waste Position (A)	Waste Position (B)
900x900	270	450

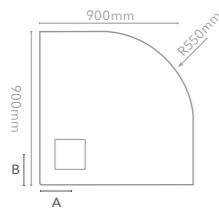

Size	Waste Position (A)	Waste Position (B)
900x900	270	200

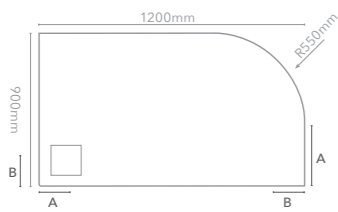

Size	Waste Position (A)	Waste Position (B)
1200x900	270	200

Please Note: For all trays, waste dimensions are to the centre of waste.

Level 25 Trays

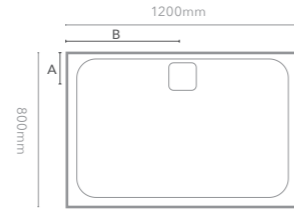

Size	Waste Position (A)	Waste Position (B)
1000x800	121.5	500
1000x900	121.5	500
1100x800	121.5	550
1100x900	121.5	550
1200x800	121.5	600
1200x900	121.5	600
1400x800	121.5	700
1400x900	121.5	700
1500x800	121.5	750
1500x900	121.5	750
1600x800	121.5	800
1600x900	121.5	800
1700x800	121.5	850
1700x900	121.5	850

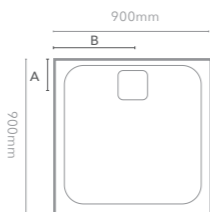

Size	Waste Position (A)	Waste Position (B)
900x900	121.5	450

MStone & Merlyn Upstand Trays

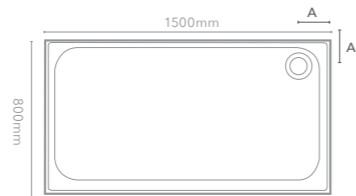

Size	Waste Position (A)	Waste Position (B)
900x760	147	
1000x800	147	
1100x760	147	
1100x800	147	
1200x700	147	
1200x760	147	
1200x800	147	
1200x900	147	
1400x800	147	
1400x900	147	
1500x700	147	
1500x800	147	
1500x900	147	
1600x800	147	
1600x900	147	
1685x700	147	
1680x760	147	

MStone & Merlyn Upstands Trays Continued...

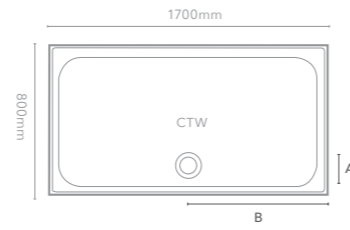

Size	Waste Position (A)	Waste Position (B)
1700x800	850	147

Waste is centred for 1700x800 tray - D178RT

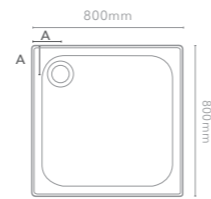

Size	Waste Position (A)	Waste Position (B)
760	147	
800	147	
900	147	

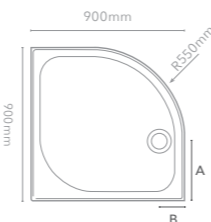

Size	Waste Position (A)	Waste Position (B)
800	250	130
900	350	130
1000	350	130

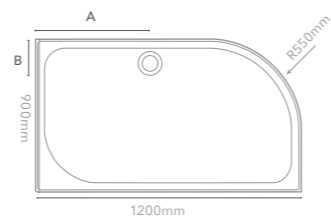

Size	Waste Position (A)	Waste Position (B)
900x760L	250	130
900x760R	250	130
1000x800L	350	130
1000x800R	350	130
1200x800L	450	130
1200x800R	450	130
1200x900L	450	130
1200x900R	450	130
1400x800L	510	300
1400x800R	510	300

CE & EN Information

The CE marking on Merlyn enclosures is a declaration that the product complies with the essential requirements of the relevant European health, safety and environmental protection legislation.

The CE marking on a product indicates to government officials that the product may be legally placed of the non conforming products by customs and enforcement authorities.

The European Union's "new approach directives" are mandatory on all member countries to enact through national legislation. This legislation requires manufacturers to display a CE marking on their product, packaging and accompanying literature. Where a new approach directive is in force, it is (with few exceptions) an offence to place a product on the market without a CE marking.

The manufacturer is legally responsible for ensuring that the product conforms to the requirements of the directive.

CE marking is one important measure that the EU has adopted to establish the single market and foster economic development for the member states. The objective of the directives is to simplify the movement of goods into and within the EU.

Packaging guide

Please note from our packaging guide the number of boxes your door will be supplied in, depending on its size and model.

Side Panels are supplied in a separate, extra box.

If the enclosure ordered is not listed in the guide, the product, installation guide and fixing kit are supplied in 1 box.

Some products are handed, please state Right Hand (R) or Left Hand (L) when ordering.

This may eventually lead to the free movement of goods throughout Europe as more and more European countries are expected to join the EU.

The European Commission thus refers to the CE marking as a "Passport" which allows products to be freely circulated within the EU single market.

Often consumers will consider CE marking on a product as an indication of conformance to laid down minimum standards and therefore, a minimum level of safety which other products may lack. CE marking is for many consumers a "Symbol of Safety."

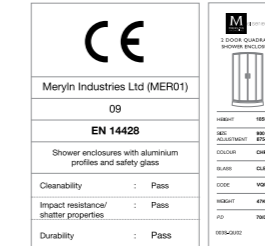

Merlyn invests heavily in its product development and as such guarantees that its glass fully complies with regulations and is manufactured in accordance with BS EN

14428. The rigorous testing of the glass ensures that the endurance, stability and water retention criteria meet high industry

Grey boxes denote location of installation guide and fixing kit



Please Note

Prices were correct at time of print March 2018. V.A.T. at the rate of 20%. E&OE. Due to circumstances beyond our control, prices may be altered including changes to the rate of V.A.T.

Due to our policy of continuous improvement, we reserve the right to amend prices, specifications and designs without prior notice. Images are for illustrated purposes only. The colours and finishes shown in the catalogue are as accurate as possible within the limits of the printing process. All descriptions, specifications and particulars contained in this brochure are intended merely to represent a general idea of the products described herein and none of these form part of any contract to give rise to any independent or collateral liability upon the company.

10 Series Sliding Door	10 Series Pivot Door & Inline Panel	10 Series 1 Door Offset Quadrant	10 Series 1 Door Quadrant	8 Series Frameless Hinge & Inline
<p>Fixed Flat Panel Moving Panel (Door) Left or Right</p>	<p>Pivot Door Inline Panel</p>	<p>Curved Fixed Panel Left or Right Moving Panel (Door) Fixed Flat Panel</p>	<p>Curved Fixed Panel Left or Right Moving Panel (Door) Fixed Flat Panel</p>	<p>Fixed Panel Left or Right Moving Panel (Door)</p> <p>*900 Hinge and Inline is supplied in one box</p>
8 Series Frameless 1 Door Quadrant	8 Series Frameless 1 Door Offset Quadrant	8 Series Frameless Sliding Door	8 Series 1 Door Quadrant	8 Series 2 Door Quadrant
<p>Moving Panel (Door), Hinged Fixed Panel Magnetic Fixed Panel</p>	<p>Moving Panel (Door), Hinged Fixed Panel Magnetic Fixed Panel</p>	<p>Fixed Panel Moving Panel (Door)</p>	<p>Fixed Panel Moving Panel (Door)</p>	<p>Fixed Panel Moving Panel (Door)</p>
8 Series Sliding Door	8 Series Infold Door & Inline Panel	8 Series Walk In	6 Series 1 Door Offset Quadrant	6 Series Framless Hinge & Inline
<p>Fixed Panel Moving Panel (Door)</p>	<p>Fixed Panel</p>	<p>Curved Fixed Panel, Straight Fixed Panel</p>	<p>Curved Fixed Panel, Straight Fixed Panel</p>	<p>Fixed Panel Moving Panel with hardware</p>

*1000, 1100 & 1200 are packaged in one box

6 Series enclosures come in 1 box, with the exception of the 1 Door Offset Quadrant as noted and Sliding Doors of 1400mm or more.

Inline Panel - *Space Solutions*

Our 6 Series range includes the option of additional Inline Panels to ensure the 6 Series can be used in any space from 670mm to 1915mm. Simply choose the adjustment for your space and we will create the ideal combination for you.

Inline Panels

6 Series Inline Panels			
Adjustment/ Wetroom Min-Max	Order Code	Price £ Exc. VAT	Price £ Inc. VAT
140	M61125	235.65	282.78
215	M61200	247.49	296.99

Sliding Door *- and Inline panel*

Sliding Door					
Size	Size of Door Supplied	Order Code	Inline Panel Supplied	Price £ Exc. VAT	Price £ Inc. VAT
950-1000	1000	M68231	-	527.66	633.19
1050-1100	1100	M68251	-	527.66	633.19
1065-1140	1000	M68231P1H	140	763.10	915.72
1140-1215	1000	M68231P2H	215	775.15	930.18
1150-1200	1200	M68241	-	527.66	633.19
1165-1240	1100	M68251P1H	140	763.31	915.97
1240-1315	1100	M68251P2H	215	775.15	930.18
1265-1340	1200	M68241P1H	140	763.31	915.97
1340-1415	1200	M68241P2H	215	775.15	930.18
1350-1400	1400	M68291	-	647.67	777.20
1360-1460	1100	M68251PPH	140+215	1010.81	1212.97
1450-1500	1500	M68261	-	689.78	827.74
1465-1540	1400	M68291P1H	140	883.34	1060.01
1540-1615	1400	M68291P2H	215	895.17	1074.20
1550-1600	1600	M68271	-	728.75	874.50
1565-1640	1500	M68261P1H	140	925.44	1110.53
1640-1715	1500	M68261P2H	215	937.29	1124.75
1650-1700	1700	M68281	-	728.75	875.50
1665-1740	1600	M68271P1H	140	964.40	1157.28
1740-1815	1600	M68271P2H	215	976.24	1171.49
1765-1840	1700	M68281P1H	140	964.40	1157.28
1840-1915	1700	M68281P2H	215	976.24	1171.49

Please add 20mm to size when using with a Side Panel.
Optional Side Panel available: See Page 58.

Pivot Door *- and Inline panel*

Pivot Door					
Size	Size of Door Supplied	Order Code	Inline Panel Supplied	Price £ Exc. VAT	Price £ Inc. VAT
670-720	700	M61201 N	-	380.11	456.13
690-740	700	M61201H	EXT	431.03	517.24
740-790	760/800	M61211 N	-	427.95	513.54
785-860	700	M61201P1H	140	615.78	738.94
850-900	900	M61221 N	-	448.64	538.37
860-935	700	M61211P1H	215	627.62	753.14
930-1005	760/800	M61211P2H	215	675.45	810.54
950-1000	1000	M61231 N	-	459.90	567.48
965-1040	900	M61221P1H	140	684.30	821.16
1040-1115	900	M61221P2H	215	696.14	835.37
1065-1140	1000	M61231P1H	140	708.57	850.28
1140-1215	1000	M61231P2H	215	720.41	864.49

Please add 20mm to size when using a Side Panel
Optional Side Panel available: See page 60

Bifold Door *- and Inline panel*

Sliding Door					
Size	Size of Door Supplied	Order Code	Inline Panel Supplied	Price £ Exc. VAT	Price £ Inc. VAT
670-720	700	M67201 N	-	590.15	708.18
690-740	700	M67201H	EXT	641.06	769.27
740-790	760/800	M67211 N	-	590.15	708.18
785-860	700	M67201PH	140	825.80	990.96
850-900	900	M67221 N	-	632.55	759.06
860-935	700	M67201P2H	215	837.64	1005.17
930-1005	760/800	M67211P2H	215	837.64	1005.17
950-1000	1000	M67231 N	-	665.27	798.32
965-1040	900	M67221P1H	140	868.21	1041.85
1040-1115	900	M67221P2H	215	880.05	1056.06
1065-1140	1000	M67231P1H	140	899.98	1079.98
1140-1215	1000	M67231P2H	215	912.78	1095.34

Please add 20mm to size when using with a Side Panel.
Optional Side Panel available: See Page 62.

Inline Panel - *Space Solutions*

Our 8 Series range includes the option of additional Inline Panels to ensure the 8 Series can be used in any space from 650mm to 1900mm. Simply choose the adjustment for your space and we will create the ideal combination for you.

Inline Panels

8 Series Inline Panels			
Adjustment/ Wetroom Min-Max	Order Code*	Price £ Exc. VAT	Price £ Inc. VAT
150	M8P140	248.52	298.22
210	M8P2200	260.23	312.28

Sliding Door *- and Inline Panel*

Sliding Door					
Size	Size of Door Supplied	Order Code	Inline Panel Supplied	Price £ Exc. VAT	Price £ Inc. VAT
950-990	1000	M88231	-	739.76	887.71
1050-1090	1100	M88251	-	739.76	887.71
1080-1140	1000	M88231P1H	150	982.48	1178.98
1140-1200	1000	M88231P2H	210	993.96	1192.75
1150-1190	1200	M88241	-	739.76	887.71
1180-1240	1100	M88251P1H	150	982.48	1178.98
1240-1300	1100	M88251P2H	210	993.96	1192.75
1280-1340	1200	M88241P1H	150	982.48	1178.98
1340-1400	1200	M88241P2H	210	993.96	1192.75
1250-1290	1300	M88240	-	899.25	1079.10
1350-1390	1400	M88291	-	935.19	1122.23
1370-1450	1100	M88251H	150+210	1236.67	1484.00
1450-1490	1500	M88261	-	967.67	1161.20
1480-1540	1400	M88291P1H	150	1177.90	1413.48
1540-1600	1400	M88291P2H	210	1189.38	1427.25
1550-1590	1600	M88271	-	979.60	1175.52
1580-1640	1500	M88261P1H	150	1210.39	1452.57
1640-1700	1500	M88261P2H	210	1221.86	1466.23
1650-1690	1700	M88281	-	1027.32	1232.78
1680-1740	1600	M88271P1H	150	1222.31	1466.78
1740-1800	1600	M88271P2H	210	1233.79	1480.55
1780-1840	1700	M88281P1H	150	1270.04	1524.05
1840-1900	1700	M88281P2H	210	1281.51	1537.82

Please add 20mm to size when using with a Side Panel.
Optional Side Panel available: See Page 40.

Hinge Door *- and Inline Panel*

Sliding Door					
Size	Size of Door Supplied	Order Code	Inline Panel Supplied	Price £ Exc. VAT	Price £ Inc. VAT
650-690	700	M81201	-	675.79	810.94
670-710	700	M81201H	EXT	751.85	902.23
710-750	760	M81210	-	677.15	812.58
750-790	800	M81211	-	677.15	812.58
780-840	700	M81201PH	150	692.69	831.22
840-900	700	M81210P1H	210	959.99	1151.99
850-890	900	M81221	-	749.65	899.58
900-960	760	M81210P2H	210	694.08	832.89
950-990	1000	M81231	-	793.67	952.40
940-1000	800	M81211PH	210	961.36	1153.63
980-1040	900	M81221P1H	150	768.39	922.07
1040-1100	900	M81221P2H	210	1016.93	1220.31
1080-1140	1000	M81231P1H	150	813.51	976.22
1140-1200	1000	M81231P2H	210	1060.96	1273.15

Please add 20mm to size when using with a Side Panel.
Optional Side Panel available: See Page 42.

Infold Door *- and Inline Panel*

Sliding Door					
Size	Size of Door Supplied	Order Code	Inline Panel Supplied	Price £ Exc. VAT	Price £ Inc. VAT
650-690	700	M84401	-	715.90	859.08
670-710	700	M84401H	EXT	772.17	926.61
710-750	760	M84410	-	727.84	873.41
750-790	800	M84411	-	742.15	890.58
780-840	700	M84401P1H	150	958.62	1150.34
840-900	700	M84401P2H	210	970.05	1164.06
850-890	900	M84421	-	752.76	903.31
900-960	760	M84410P1H	210	982.03	1178.44
950-990	1000	M84431	-	819.37	983.25
940-1000	800	M84411P2H	210	996.80	1196.16
980-1040	900	M84421P1H	150	995.47	1194.57
1040-1100	900	M84421P2H	210	1006.90	1208.28
1080-1140	1000	M84431P1H	150	1062.09	1274.51
1140-1200	1000	M84431P2H	210	1073.56	1288.27

Please add 20mm to size when using with a Side Panel.
Optional Side Panel available: See Page 44.

MERLYN

series

MERLYN

Unit 8, Purcellsinch Industrial Park, Dublin Road, Kilkenny, Ireland, R95 HP71.

T 0808 1011 429 / F 0808 1011 428

www.merlynshowering.com