**THE
ONE
BOOK**

SHOWER &
TAP GUIDE

JANUARY
2018 EDITION





NEW PRODUCT



ALL PRESSURE

For all pressure systems



HIGH PRESSURE

For high pressure systems



EARTHWISE™

Product either comes pre-fitted with a flow regulator or a regulator can be fitted to reduce water wastage and help protect the environment.



THERMOSTATIC CONTROL

Accurately controls the water temperature to remain below a pre-set level to prevent the risk of scalding



HANDSET FUNCTION

Identifies the number of spray functions from the shower handset or shower head



1/4 & 1/2 TURN CERAMIC DISC

This technology ensures a smooth 'on' and 'off' operation



EASY FIT

Easy fit connections make fitting a bar valve quick and easy



BACK NUTS

Product is supplied complete with metal back nuts



PULL OUT RINSER

Features a pull out rinser for extra versatility in the kitchen



SENSOR RANGE

Battery or mains operated sensor taps for the ultimate in hygiene and water conservation



TAMPER PROOF

The specialist design of these products reduces vandalism and risk from flooding



TWIST FREE HOSE

Product features 360° swivel hose adapter to make showering easier



WITH AIR

Mixing air and water, to enable water saving with no compromise on experience



INCLUSIVE DESIGN

Products which are easy to use by all the family



TMV APPROVED

Tested to TMV2 or TMV3 Buildcert standards for thermostatic performance, reducing the risk of scalding by accurately controlling the water temperature



red dot design award



Best Design Awards Winner 2015



METHVEN

Methven – we make water amazing.

We believe that how a shower performs is just as important as how it looks. That's why we blend ingenious innovation with beautiful human design. A pioneer in bathroom plumbing, we are renowned globally for breakthrough shower and tap design and product development, distinctive aesthetics and environmental-mindedness. Our dedication to water conservation and quality products has been recognised with a host of global awards for design and innovation.



Deva has over 25 years of supplying showers and taps in the UK and offers a wide range of quality products at the right price.

This brochure includes all the vital information you need when specifying our products and the easy to use new-look icons allow you to quickly identify each products benefits. For more information visit our websites or contact us direct.



NEXT DAY DELIVERY

ON ORDERS RECEIVED
BEFORE 4PM (3PM ON FRIDAYS)[†]



FREEPHONE 0800 195 1602



FAX ORDER LINE: 01942 680 190

EMAIL: sales@uk.methven.com

OPENING TIMES:

8am - 5pm Monday - Friday

Showers 18

Tapware 50

Showers 64

Shower Flow Regulators 85

Bathroom Taps 90

Tap Flow Regulators 93

Kitchen Taps 120

Commercial 130

Wastes & Spares 154

Index 165



Creating amazing water
experiences since

1886

Creating amazing water experiences is what we do every day at Methven, and have done since 1886 when George Methven first started as a producer of brass and iron hardware in Dunedin, New Zealand.

Today, Methven is world renowned for beautifully designed, award-winning showers, taps and valves. It all stems from our knowledge of water. Our unique history as an island nation has taught us to take care of nature's most precious resource.

Over the years we have learned how to harness its power to cleanse, calm, refresh and invigorate. And it's this expertise - combined with our passion for design and innovation - that fuels our ongoing mission to create amazing water experiences, just for you.





Lake Wakitipu
Queenstown, NZ



Committed to the environment

At Methven we're committed to protecting the planet and reducing our environmental impact to help conserve the earth's natural resources.

Water is the earth's most precious commodity. Currently around one fifth of the world lives in a water scarce region. And with water usage growing at twice the population rate, its preservation will only become more vital in years to come.

That's why at Methven we make taking care of water a primary focus in every product we develop.

For example, did you know that your shower uses around 30% of your household water consumption? So we've developed innovative technologies - such as Satinjet and Aurajet - that deliver a luxurious shower experience, all whilst actually using less water.

Methven. Conserving energy and water to protect
the planet for generations to come.



METHVEN

Aurajet™

The next generation of showering has arrived.

Introducing Aurajet™. Our most advanced, most invigorating shower experience ever, that turns conventional showering on its head.

Invisible nozzles generate individual jets of water that collide against precisely angled surfaces hidden within the contours of the unique halo-shaped showerhead.

The result is a stunning fan of luxuriously dense droplets that delivers a highly efficient shower with 20% more spray force and twice the amount of water contact on your skin than a conventional shower*. All this adds up to an enveloping warmth that has to be felt to be believed, and a heavenly experience that puts you in a great space, every time you shower.





20%

MORE SPRAY FORCE*

2x

**THE AMOUNT OF
SKIN CONTACT***

* Compared to a Methven Conventional Shower at 9L per minute.



OUR SHOWERING TECHNOLOGIES

METHVEN

Aurajet™

The next generation of showering has arrived.

Aurajet™. Our most advanced, most invigorating shower experience ever, that turns conventional showering on its head.

Invisible nozzles generate individual jets of water that collide against precisely angled surfaces hidden within the contours of the unique halo-shaped showerhead.

An engineered polymer with hydrophobic properties resists the build-up of limescale. The result is a stunning fan of luxuriously dense droplets that delivers a highly efficient shower with:

- **20% more spray force***
- **2 x the amount of skin contact***



Twice the coverage

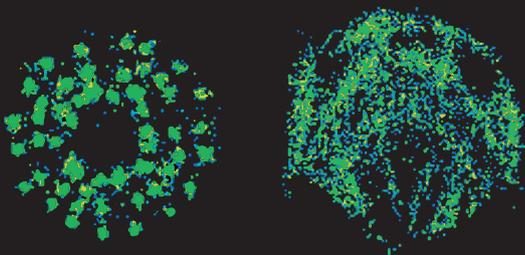

TRADITIONAL SHOWER SPRAY

AURAJET® SPRAY

Better stimulation of nerve endings

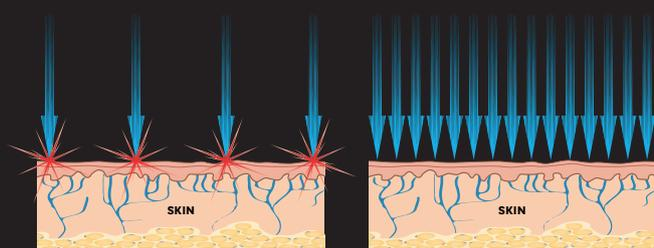

TRADITIONAL SHOWER SPRAY

AURAJET® SPRAY

The water flow rate is optimised at 9 litres per minute to be water efficient without compromising the luxurious spray performance

* Compared to a Methven Conventional Shower. Flow rate of both products at 9L per minute and tested as per AS 3662-2013 Appendix H.

METHVEN

Satinjet®

A sensation only your skin can truly understand.

Turn an everyday ritual into a shower experience with award-winning Satinjet® technology from Methven.

Unlike conventional showers, Satinjet® uses unique twin-jet technology to create optimum water droplet size and pressure, with over 300,000 droplets per second. The result is an immersive, full-body shower sensation that transforms your regular shower into an experience like no other.

And because we know everyone has their own idea of the perfect shower, Methven has crafted a range of Satinjet® showers you can match to your individual needs – from gentle and enveloping to powerful and invigorating.

Satinjet® from Methven – prepare yourself for a truly sensational shower experience.





CONFIDENCE IN METHVEN / ACCREDITATIONS



Certificate Number 868
ISO 9001

ISO 9001 ACCREDITED

We believe that quality of service, before and after sale, is of the utmost importance. It's for this reason that we constantly strive to improve both our service to you and our product offering by listening to your comments and suggestions. By doing this it has helped us achieve and retain the renowned ISO9001 since 1995 – proving to you that we are a quality assured company.



Certificate Number 868
ISO 14001

ISO 14001 ACCREDITED

We believe in looking after the environment by actively seeking to reduce energy consumption, while improving energy efficiency and using renewable or recyclable materials wherever we can. Besides developing our own ideas, whether they are new innovations in design or environmental issues, we also work closely with trade bodies to further ensure you're getting the best products and service possible. In recognition of our focus on the environment, we have achieved ISO 14001 accreditation; demonstrating our commitment towards environmental issues and our pledge to reducing the impact our business has on the environment.



FREE RIBA APPROVED SEMINARS

We also offer free continuing professional development training on water saving, sustainability and regulatory requirements in partnership with the Royal Institute of British Architects (RIBA) Enterprises. For more information call 0800 195 1602 or email cpd@uk.methven.com.



BATHROOM MANUFACTURERS ASSOCIATION (BMA)

Methven UK are members of the Bathroom Manufacturers Association. They ensure the industry has a recognised voice with UK government, industry regulators and European standards bodies. The BMA provide an authoritative voice for the industry on all matters affecting manufacturing and supply.



WRAS WATER REGULATIONS ADVISORY SCHEME

WRAS approves water fittings and materials to meet the minimum requirements of the Water Supply (Water Fittings) Regulations 1999 in England and Wales, the Water Byelaws 2000 in Scotland and the Water Regulations in Northern Ireland.



METHVEN APPROVED PLUMBERS SCHEME (MAPS)

Methven operate a nationwide network of approved plumbers to provide specialist on-site support should you require it. For more information call 0800 195 1602.



TMV BUILDCERT APPROVAL

TMV Buildcert approval is the recognised standard of thermostatic control. Approval at TMV2 indicates suitability for use in the domestic home, whilst TMV3 approval indicates suitability for commercial installations such as care homes and hospitals.

METHVEN SUPPORTS THE EUROPEAN WATER LABEL SCHEME

water label

L/Min	Water Use	without savings device	with savings device
Max. 6			6
Max. 8			
Max. 10		10	
Max. 13			
> 13			

www.europeanwaterlabel.eu

To save water, the savings device supplied must be fitted. Always refer to the manufacturer's instructions for guidance.

water label

L/Min	6	✓
L/Min	10	✗

Type of measurement: Flow rate value identifies exact litres per minute usage.

Performance Bands: Rated 6 to 13 and above.

Actual capacity or performance of the product with flow rate saving.

Actual capacity or performance of the product without flow rate saving.

We offer a comprehensive range of showers and bathroom taps which meet industry standards for water efficiency. The scheme identifies products which when installed and used correctly, will use less water, saving energy and money. Look for the Water Label across our product range which identifies products that offer a water saving option.

Visit: www.europeanwaterlabel.eu for more information.

CONFIDENCE IN US

The confidence we have in our products mean we are delighted to offer a comprehensive set of warranties for all of our products in our Methven and Deva brands. All details are laid out below, for full terms and conditions please visit our website at www.methven.com or contact us on 0800 195 1602.



METHVEN

METHVEN BRAND WARRANTY (SUBJECT TO THE TERMS AND CONDITIONS)		
PRODUCT	PARTS	LABOUR
AURAJET™ Shower heads and handsets	LIFETIME REPLACEMENT*	
SATINJET® & AIRSTREAM Shower heads and handsets	5 YEARS	
TAPWARE	20 YEARS	2 YEARS
THERMOSTATIC VALVES	5 YEARS	2 YEARS
SHOWER ACCESSORIES	1 YEAR	
REPLACEMENT COMPONENTS AND PARTS	1 YEAR	



DEVA BY METHVEN BRAND WARRANTY (SUBJECT TO THE TERMS AND CONDITIONS)		
PRODUCT	PARTS	LABOUR
CHROME TAPWARE**	12 YEARS	2 YEARS
SHOWER VALVES	5 YEARS	2 YEARS
SHOWER ACCESSORIES	1 YEAR	
ELECTRICAL PRODUCTS (INCLUDING SENSOR TAPS)	2 YEARS	2 YEARS

* For the lifetime of the original purchaser

** All other finishes 5 Years Parts, 2 Years Labour

Any product that has not been fitted in a private dwelling located in the United Kingdom or the Republic of Ireland will be subject to our Commercial Warranty of 12 months parts and labour, as set out in Condition 8 of Methven's Terms and Conditions of Sale. For full terms and conditions see www.methven.com

METHVEN

“For me design is absolutely everything. Not just how it looks, it’s about how it feels, functions and the experience you get from it.”

George Clarke

Methven UK
Brand Ambassador



George Clarke is an architect, creative director of George Clarke + Partners, and a founder of TV production company Amazing Productions.

"I was filming for Amazing Spaces in New Zealand and walked through one of the bathrooms. Automatically my eye just got drawn to the shower head. For me, design is absolutely everything. Not just about how it looks, it's about how it feels, functions and the experience you get from it.

When I turned the Methven shower on, it was really beautiful. It felt like a really different, more comfortable, quality experience.

What's really clever for me about Methven is the technology, the R&D and innovation that's gone into it. Their team of engineers are obsessed about how water actually comes out of a shower head, what direction the jets are being pushed in, and how you can change the dynamics of that water to give you a unique shower experience. Mind-blowing.

When I found out about their history, I was staggered. When you see new products, innovative design, some things that even look a bit futuristic you tend to associate that with a new company, and think that they're the new kids on the block. Methven have been going for 130 years. That gives me a massive amount of trust and loyalty to the brand. You know that they've got all that experience and knowledge behind them to design and make really beautiful products.

I never under-estimate what that heritage means, not only to the business, but to the things that they make. Methven having that level of innovation and that passion for a unique shower experience meant it was a no-brainer for me to join them".

George Clarke – Methven UK Brand Ambassador

Taking geometric styling and softens the appearance with slightly rounded edges for a truly unique and contemporary look. RUA features our innovative Aurajet® technology delivering 20% more spray force and twice the skin contact of a conventional shower.*

*compared to a Methven conventional shower



ULTRA WIDE COVERAGE

A full-bodied spray for all-over warmth and maximum body contact.

Aurajet® RUA HANDSET

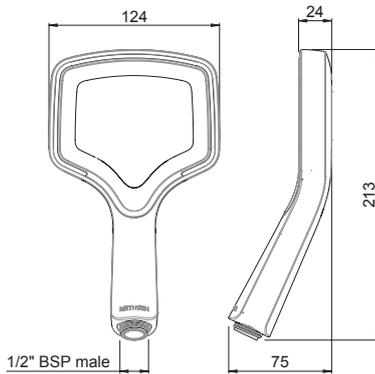

INLET CONNECTIONS:
1/2" BSP

WORKING PRESSURE:
1.0 – 5.0 bar

- Limescale resistant - hydrophobic properties resists the build up of limescale
- Water efficient without compromising performance



water label L/Min 7.5

RUHSCPUK Chrome Ex.VAT £87.45 Inc.VAT £104.94

RUHSCPWHUK Chrome & White Ex.VAT £87.45 Inc.VAT £104.94

Aurajet® RUA HAND SHOWER

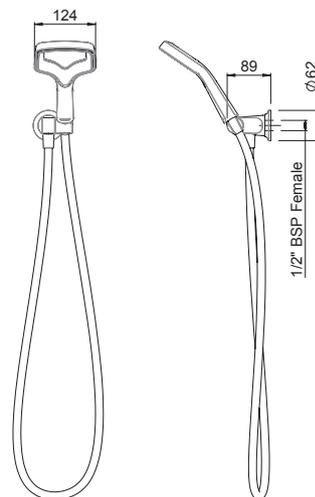
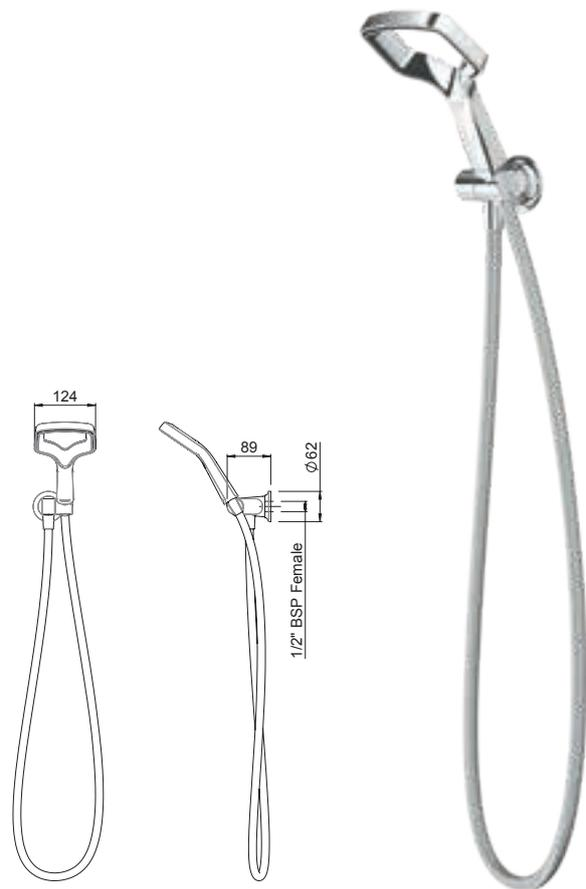

INLET CONNECTIONS:
1/2" BSP

WORKING PRESSURE:
1.0 – 5.0 bar

- Limescale resistant - hydrophobic properties resists the build up of limescale
- Water efficient without compromising performance
- Quick fit connector for easy installation
- Comes complete with 15mm (1/2" BSP) threaded connection



water label L/Min 7.5

RUWOBGPUK Chrome Ex.VAT £166.95 Inc.VAT £200.34

RUWOBGPWHUK Chrome & White Ex.VAT £166.95 Inc.VAT £200.34

Methven was founded in New Zealand in 1886 as a manufacturer of high quality brassware. Over the years we have learned a lot about water, how to treat this precious natural resource with care and harness its power to cleanse, calm, refresh and invigorate. Today, we are renowned for world-leading technology, beautiful design, and award winning showers, taps and valves. We continue our mission to create amazing water experiences for you.



Aurajet[®] RUA RAIL SHOWER

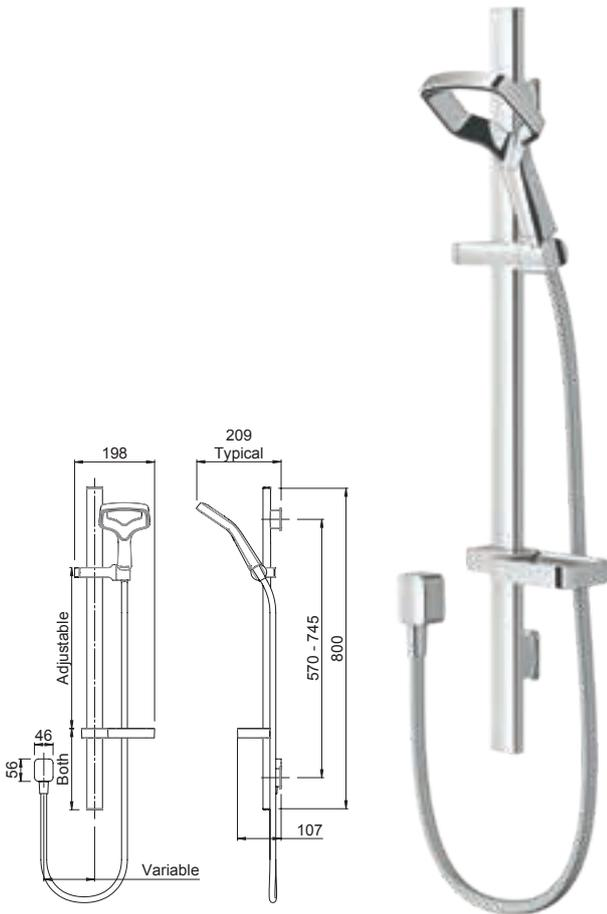

INLET CONNECTIONS:
1/2" BSP

WORKING PRESSURE:
1.0 - 5.0 bar

- Limescale resistant – hydrophobic properties resists the build up of limescale
- Water efficient without compromising performance
- Riser rail features adjustable brackets - ideal for retrofit
- Easy to use handset slider
- Comes complete with 15mm (1/2" BSP) threaded connection



water label L/Min 7.5

RUSRCPUK Chrome Ex.VAT £195.22 Inc.VAT £234.26

RUSRCPHUK Chrome & White Ex.VAT £195.22 Inc.VAT £234.26

Aurajet[®] RUA COOL TO TOUCH BAR MIXER SHOWER KIT

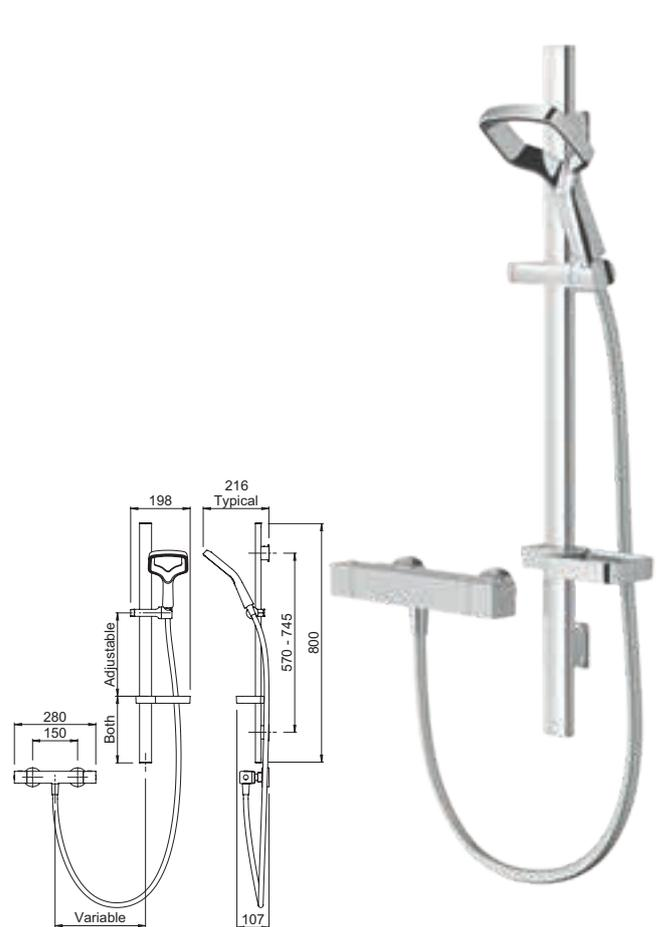

VALVE:
Thermostatic

OPERATION:
Separate flow and temperature controls

INLET CONNECTIONS:
15mm compression

WORKING PRESSURE:
1.0 - 5.0 bar

- Limescale resistant – hydrophobic properties resists the build up of limescale
- Safe cool to touch body
- 38°C hot stop with override facility
- Includes easy fit connections
- Riser rail features adjustable brackets – ideal for retrofit



water label L/Min 7.5

RUCTSCPUK Chrome Ex.VAT £294.15 Inc.VAT £352.98

RUCTSCPHUK Chrome & White Ex.VAT £294.15 Inc.VAT £352.98

A triumph of imagination, featuring intriguing sculptural contours coupled with modern elegant forms that bravely defy convention. Aio features our innovative Aurajet® technology delivering 20% more spray force and twice the skin contact of a conventional shower.*

*compared to a Methven conventional shower



ULTRA WIDE COVERAGE

A full-bodied spray for all-over warmth and maximum body contact.

Aurajet® AIO SHOWER SYSTEM

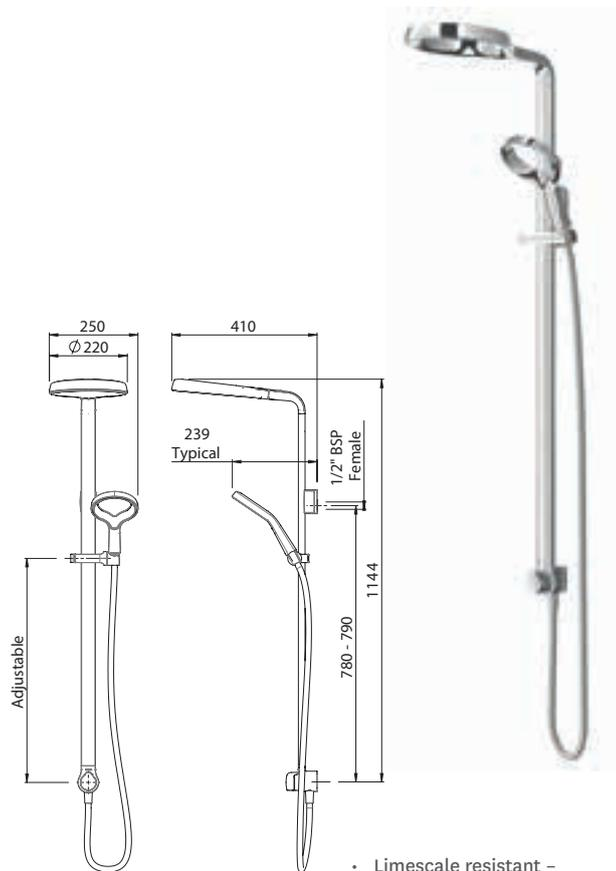

INLET CONNECTIONS:

1/2" BSP

WORKING PRESSURE:

1.0 – 5.0 bar

- Limescale resistant – hydrophobic properties resists the build up of limescale
- Water efficient without compromising performance
- Integrated diverter
- Rotary ceramic diverter cartridge
- Quick fit connector between head & rail for easy installation
- Comes complete with 15mm (1/2" BSP) threaded connection
- Fitted with 12 l/min flow regulator in overhead and 9 l/min in handset
- Twin with a Tahī, Kaha or Kiri single outlet shower valve

water label L/Min **12.0**



AOSSCPUK Chrome

Ex.VAT £560.87 Inc.VAT £673.04

AOSSCPWHUK Chrome & White

Ex.VAT £560.87 Inc.VAT £673.04

Aurajet® AIO OVERHEAD SHOWER

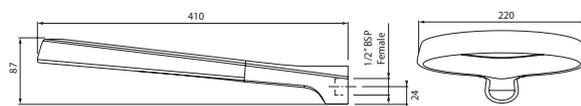

INLET CONNECTIONS:

1/2" BSP

WORKING PRESSURE:

1.0 – 5.0 bar

- Limescale resistant – hydrophobic properties resists the build up of limescale
- Water efficient without compromising performance
- Ultra wide spray coverage
- Quick fit connector for easy installation
- Fitted with 12 l/min flow regulator
- Comes complete with 15mm (1/2" BSP) threaded connection



water label L/Min **12.0**

AOSSCPUK Chrome

Ex.VAT £233.15 Inc.VAT £279.78

AOSSCPWHUK Chrome & White

Ex.VAT £233.15 Inc.VAT £279.78



Methven was founded in New Zealand in 1886 as a manufacturer of high quality brassware. Over the years we have learned a lot about water, how to treat this precious natural resource with care and harness its power to cleanse, calm, refresh and invigorate. Today, we are renowned for world-leading technology, beautiful design, and award winning showers, taps and valves. We continue our mission to create amazing water experiences for you.



Aurajet[®] AIO HANDSET

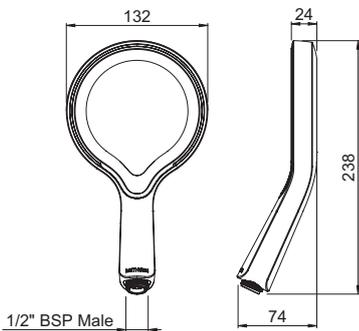

INLET CONNECTIONS:
1/2" BSP

WORKING PRESSURE:
1.0 – 5.0 bar

- Limescale resistant – hydrophobic properties resists the build up of limescale
- Water efficient without compromising performance



water label L/Min 9.0

AOHSCPUK Chrome

Ex.VAT £83.34 Inc.VAT £100.01

AOHSCPWHUK Chrome & White

Ex.VAT £83.34 Inc.VAT £100.01

Aurajet[®] AIO WALL SHOWER ON SHORT ARM

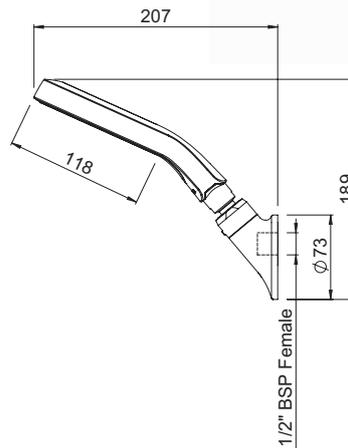

INLET CONNECTIONS:
1/2" BSP

WORKING PRESSURE:
1.0 – 5.0 bar

- Limescale resistant – hydrophobic properties resists the build up of limescale
- Quick fit connector for easy installation
- Ball joint creates a greater range of rotational and angular adjustment
- Water efficient without compromising performance
- Comes complete with 15mm (1/2" BSP) threaded connection



water label L/Min 9.0

AOSACPUK Chrome

Ex.VAT £144.19 Inc.VAT £173.03

AOSACPWHUK Chrome & White

Ex.VAT £144.19 Inc.VAT £173.03

A triumph of imagination, featuring intriguing sculptural contours coupled with modern elegant forms that bravely defy convention. Aio features our innovative Aurajet® technology delivering 20% more spray force and twice the skin contact of a conventional shower.*

*compared to a Methven conventional shower



ULTRA WIDE COVERAGE

A full-bodied spray for all-over warmth and maximum body contact.

Aurajet® AIO HI RISE SHOWER

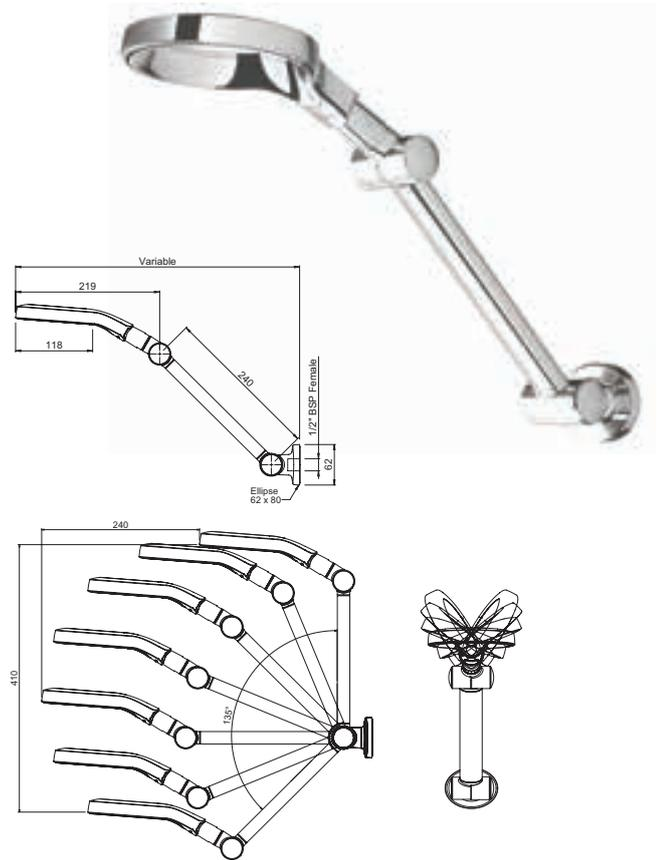

INLET CONNECTIONS:
1/2" BSP
WORKING PRESSURE:
1.5 – 5.0 bar

- Limescale resistant – hydrophobic properties resists the build up of limescale
- Hold firm arm offering a wide range of movement
- Water efficient without compromising performance
- Comes complete with 15mm (1/2" BSP) threaded connection



water label **L/Min 9.0**

AOHRCPUK Chrome

Ex.VAT £219.10 Inc.VAT £262.92

AOHRCPWHUK Chrome & White

Ex.VAT £219.10 Inc.VAT £262.92

Aurajet® AIO HAND SHOWER

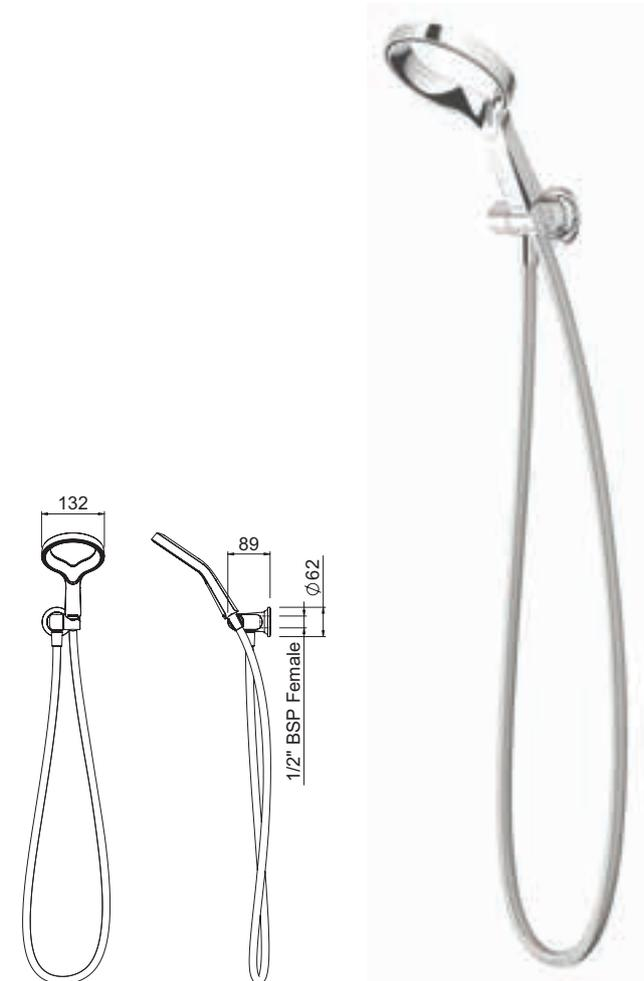

INLET CONNECTIONS:
1/2" BSP
WORKING PRESSURE:
1.0 – 5.0 bar

- Limescale resistant – hydrophobic properties resists the build up of limescale
- Quick fit connector for easy installation
- Water efficient without compromising performance
- Comes complete with 15mm (1/2" BSP) threaded connection



water label **L/Min 9.0**

AOWBCPUK Chrome

Ex.VAT £159.18 Inc.VAT £191.02

AOWBCPWHUK Chrome & White

Ex.VAT £159.18 Inc.VAT £191.02

Methven was founded in New Zealand in 1886 as a manufacturer of high quality brassware. Over the years we have learned a lot about water, how to treat this precious natural resource with care and harness its power to cleanse, calm, refresh and invigorate. Today, we are renowned for world-leading technology, beautiful design, and award winning showers, taps and valves. We continue our mission to create amazing water experiences for you.



Aurajet[®] AIO RAIL SHOWER

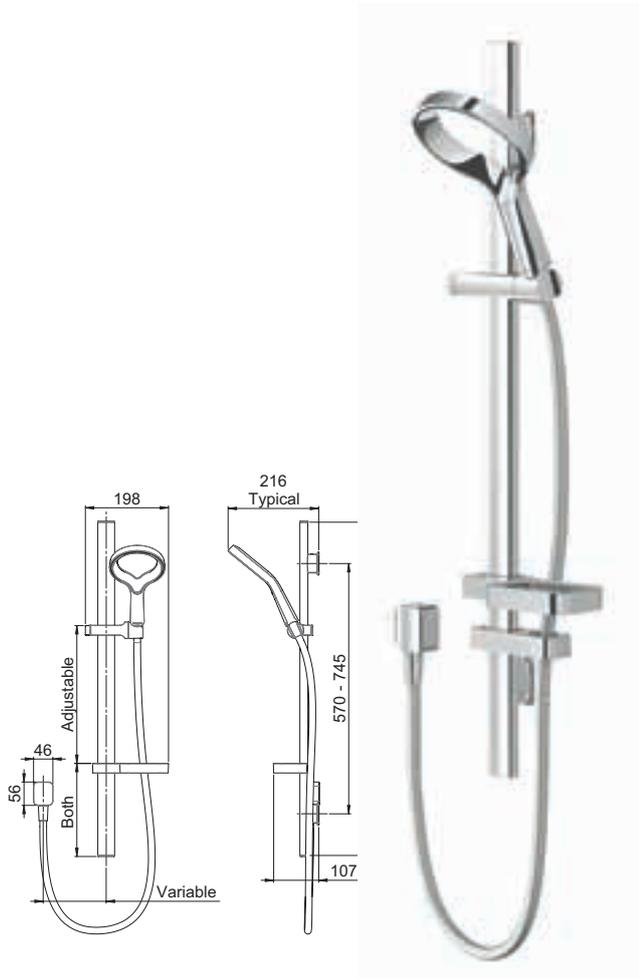

INLET CONNECTIONS:
½" BSP
WORKING PRESSURE:
1.0 – 5.0 bar

- Limescale resistant – hydrophobic properties resists the build up of limescale
- Water efficient without compromising performance
- Riser rail features adjustable brackets – ideal for retrofit
- Easy to use handset slider
- Comes complete with 15mm (½" BSP) threaded connection



water label L/Min 9.0

AOSRCPUK Chrome Ex.VAT £186.33 Inc.VAT £223.60

AOSRCPWHUK Chrome & White Ex.VAT £186.33 Inc.VAT £223.60

Aurajet[®] AIO COOL TO TOUCH BAR MIXER SHOWER KIT

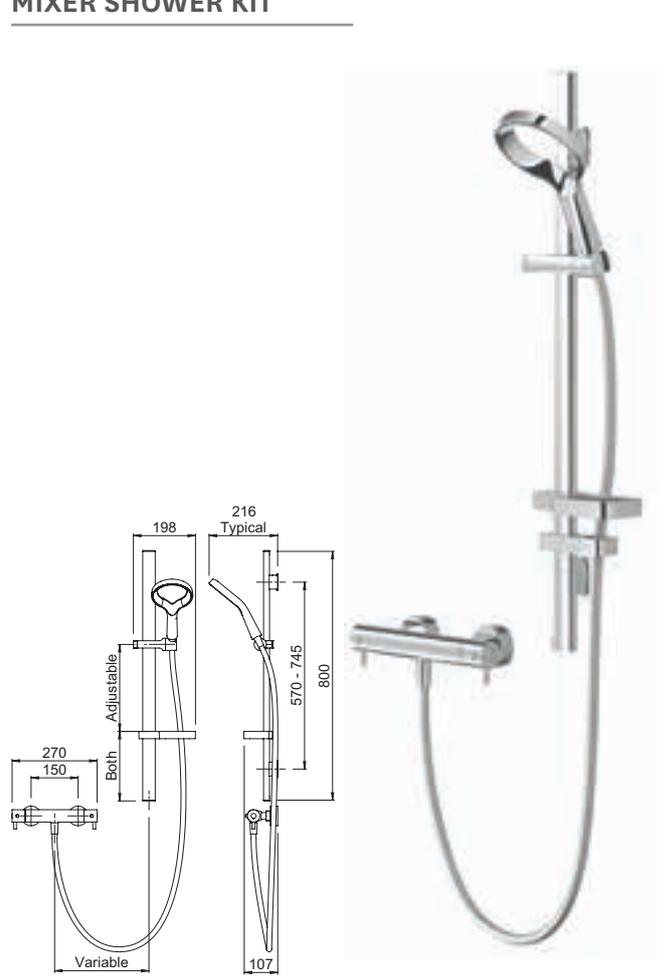

VALVE:
Thermostatic
OPERATION:
Separate flow and temperature controls
INLET CONNECTIONS:
15mm Compression
WORKING PRESSURE:
1.0 – 5.0 bar

- Limescale resistant – hydrophobic properties resists the build up of limescale
- Safe cool to touch body
- 38°C hot stop with override facility
- Eco flow control with override facility
- Includes easy fit connections
- Riser rail features adjustable brackets – ideal for retrofit
- Easy to use handset slider



water label L/Min 9.0

AOCTSCPUK Chrome Ex.VAT £279.97 Inc.VAT £335.96

AOCTSCPWHUK Chrome & White Ex.VAT £279.97 Inc.VAT £335.96

Tahi's contemporary geometric styling and sophisticated design complements the finest of architectural design settings. Featuring slim lines and intuitive design, Tahi is simple elegance in every sense.



ULTRA WIDE COVERAGE

A full-bodied spray for all-over warmth and maximum body contact.

Satinjet® TAHI HANDSET

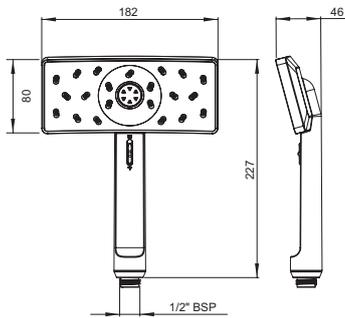

INLET CONNECTIONS:
1/2" BSP
WORKING PRESSURE:
1.5 - 5.0 bar

- Two types of spray - Satinjet body shower or massage
- Change spray pattern by simply sliding the switch



water label **L/Min 9.0**

SJT23 Chrome & Graphite

Ex.VAT **£65.54** Inc.VAT **£78.65**

Satinjet® TAHI SHOWER SYSTEM

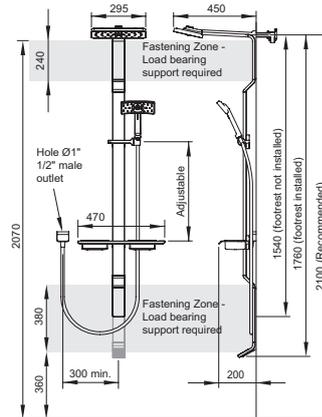

INLET CONNECTIONS:
1/2" BSP
WORKING PRESSURE:
1.5 - 5.0 bar

- Dual friction lock technology allowing easy adjustment of handset and shelf height
- Overhead shower can be rail integrated or separately mounted
- Change the spray pattern on the handset by simply sliding the switch
- Comes complete with 1/2" BSP threaded connection



water label **L/Min 11.0**

SJT006 Chrome & Graphite

Ex.VAT **£889.52** Inc.VAT **£1,067.42**

Methven was founded in New Zealand in 1886 as a manufacturer of high quality brassware. Over the years we have learned a lot about water, how to treat this precious natural resource with care and harness its power to cleanse, calm, refresh and invigorate. Today, we are renowned for world-leading technology, beautiful design, and award winning showers, taps and valves. We continue our mission to create amazing water experiences for you.



TAHI CONCEALED MIXER VALVE (SINGLE OUTLET)

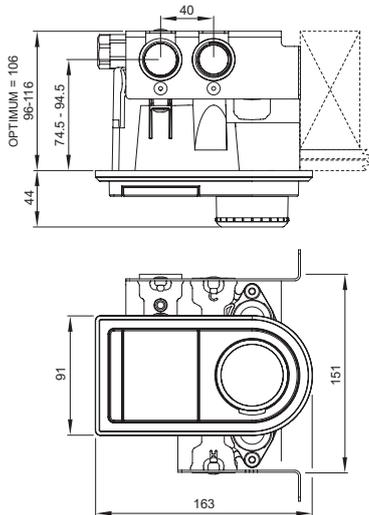

VALVE:
Thermostatic
OPERATION:
Separate flow and temperature controls
INLET CONNECTIONS:
3/4" Female
WORKING PRESSURE:
0.5 - 5.0 bar

- 38°C temperature hot stop with override facility
- Discreet low profile installation
- Easy to use lift lever flow control



TAHI 1000 Chrome

Ex.VAT £468.17 Inc.VAT £561.80

TAHI CONCEALED MIXER VALVE (2 OUTLETS)

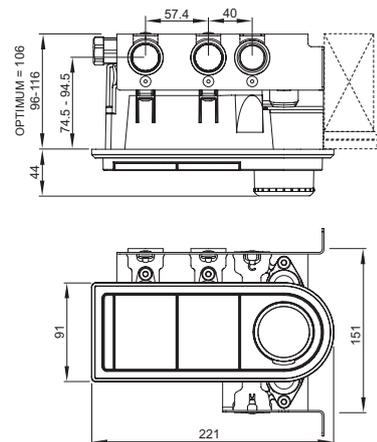

VALVE:
Thermostatic
OPERATION:
Separate flow and temperature controls
INLET CONNECTIONS:
3/4" Female
WORKING PRESSURE:
0.5 - 5.0 bar

- 38°C temperature hot stop with override facility
- Discreet low profile installation
- Easy to use lift lever flow control



TAHI 2000 Chrome

Ex.VAT £561.80 Inc.VAT £674.16

Kaha's crisp continuous chrome edge seamlessly blends with soft curves to create unmistakable yet timeless design style. Rounded, thin and tapering lines finish this softer, slightly organic style. The modern, dynamic design accents of Kaha will establish a distinctive presence in any home.



ULTRA WIDE COVERAGE

A full-bodied spray for all-over warmth and maximum body contact.

Satinjet® KAHA HANDSET

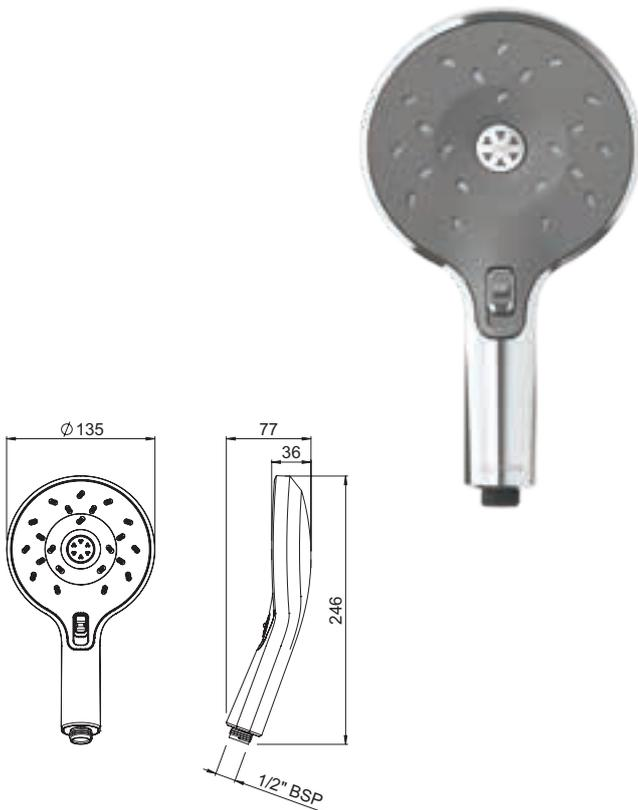

INLET CONNECTIONS:
1/2" BSP
WORKING PRESSURE:
0.35 – 5.0 bar

- Two types of spray – Satinjet body shower or massage
- Change spray pattern by simply sliding the switch
- Supplied with 9L/min flow regulator

Satinjet® KAHA SHOWER HEAD

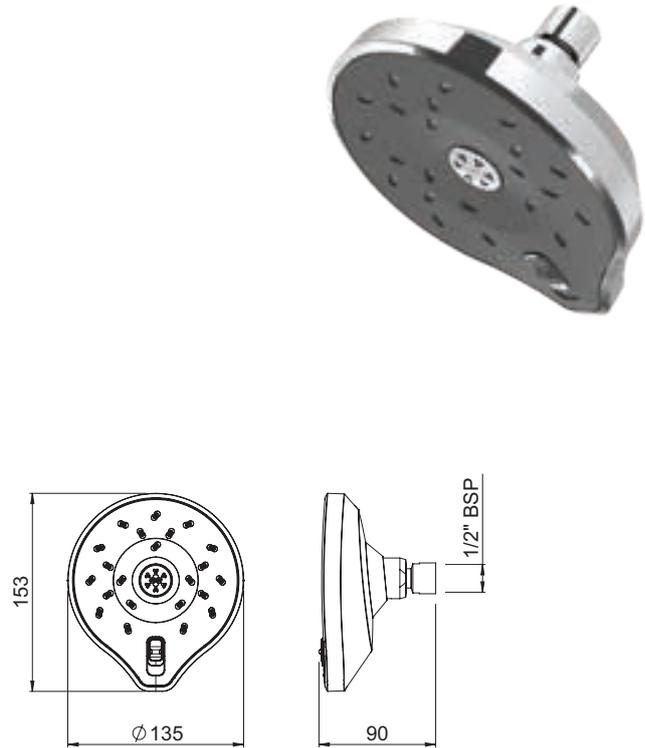

INLET CONNECTIONS:
1/2" BSP
WORKING PRESSURE:
0.35 – 5.0 bar

- Two types of spray – Satinjet body shower or massage
- Change spray pattern by simply sliding the switch
- Supplied with 9 l/min flow regulator
- Swivel joint



water label	L/Min	9.0	<input checked="" type="checkbox"/>
	L/Min	20.9	<input type="checkbox"/>

KOHPCPUK Chrome & Graphite Ex.VAT £65.54 Inc.VAT £78.65

KOHPCWHUK Chrome & White Ex.VAT £65.54 Inc.VAT £78.65



water label	L/Min	9.0	<input checked="" type="checkbox"/>
	L/Min	20.0	<input type="checkbox"/>

KOWSCPUK Chrome & Graphite Ex.VAT £70.23 Inc.VAT £84.28

Methven was founded in New Zealand in 1886 as a manufacturer of high quality brassware. Over the years we have learned a lot about water, how to treat this precious natural resource with care and harness its power to cleanse, calm, refresh and invigorate. Today, we are renowned for world-leading technology, beautiful design, and award winning showers, taps and valves. We continue our mission to create amazing water experiences for you.



KAHA CONCEALED MIXER VALVE (SINGLE OUTLET)



KAHA 1VA Chrome (ABS plate)

KAHA 1V Chrome (Brass plate)

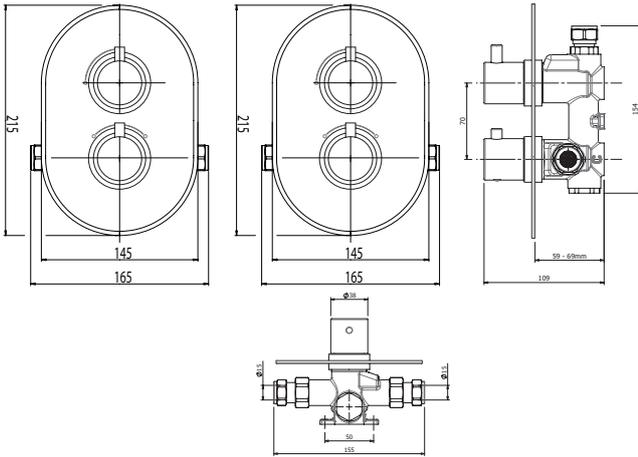

VALVE:
Thermostatic
OPERATION:
Separate flow and temperature controls
INLET CONNECTIONS:
15mm Compression
WORKING PRESSURE:
0.2 – 5.0 bar

- 38°C temperature hot stop with override facility
- Available with brass or ABS concealing plate
- Concealed shower spindle extension available see page 160



water label	L/Min	14.0	✓
	L/Min	34.0	✗

KAHA 1V Chrome (Brass plate)

Ex.VAT £279.97 Inc.VAT £335.96

KAHA 1VA Chrome (ABS plate)

Ex.VAT £235.80 Inc.VAT £282.96

KAHA CONCEALED MIXER VALVE (2 OUTLETS)



KAHA 2VDIVA Chrome (ABS plate)

KAHA 2VDIV Chrome (Brass plate)

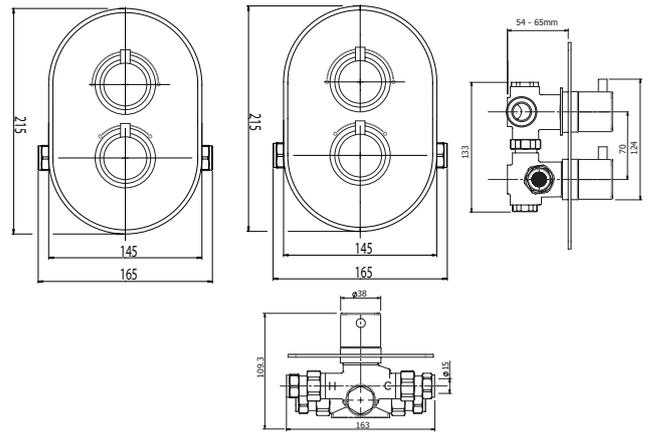

VALVE:
Thermostatic
OPERATION:
Separate flow and temperature controls
INLET CONNECTIONS:
15mm Compression
WORKING PRESSURE:
0.5 – 5.0 bar

- Diverter cartridge to two outlets
- 38°C temperature hot stop with override facility
- Available with brass or ABS concealing plate
- Concealed shower spindle extension available see page 160



water label	L/Min	14.0	✓
	L/Min	30.5	✗

KAHA 2VDIV Chrome (Brass plate)

Ex.VAT £326.78 Inc.VAT £392.14

KAHA 2VDIVA Chrome (ABS plate)

Ex.VAT £282.61 Inc.VAT £339.13

Kaha's crisp continuous chrome edge seamlessly blends with soft curves to create unmistakable yet timeless design style. Rounded, thin and tapering lines finish this softer, slightly organic style. The modern, dynamic design accents of Kaha will establish a distinctive presence in any home.



ULTRA WIDE COVERAGE

A full-bodied spray for all-over warmth and maximum body contact.

KAHA CONCEALED MIXER VALVE (3 OUTLETS)



KAHA 3VDIVA Chrome (ABS)

KAHA 3VDIV Chrome (Brass)

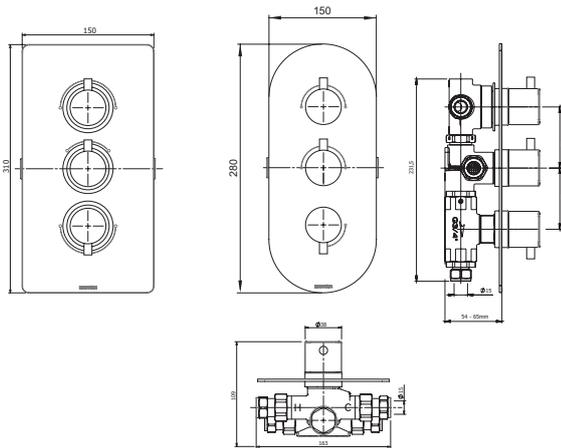

VALVE:

Thermostatic

OPERATION:

Separate flow and temperature controls

INLET CONNECTIONS:

15mm Compression

WORKING PRESSURE:

1.0 – 5.0 bar

- Diverter cartridge to two outlets and separate stopcock for bathfill
- 38°C temperature hot stop with override facility
- Available with brass or ABS concealing plate
- Rectangular ABS concealing plate
- Concealed shower spindle extension available see page 160



water label	L/Min	20.0	✓
	L/Min	32.0	✗

KAHA 3VDIV Chrome (Brass)

Ex.VAT £420.42 Inc.VAT £504.50

KAHA 3VDIVA Chrome (ABS plate)

Ex.VAT £376.25 Inc.VAT £451.50

METHVEN Satinjet®

A sensation only your skin can truly understand.



Turn an everyday ritual into a shower experience with award-winning Satinjet® technology from Methven.

Unlike conventional showers, Satinjet® uses unique twin-jet technology to create optimum water droplet size and pressure, with over 300,000 droplets per second. The result is an immersive, full-body shower sensation that transforms your regular shower into an experience like no other.



Waipori offers a widespread Satinjet spray coverage for relaxation and cleansing. Curved edges and faces soften the geometric styling of Waipori, making it a modern and attractive alternative to square styles. The range is characterised by tapering lines, subtly rounded faces and distinctive arcs.



WIDE SPRAY

A well balanced wide spray that is pampering, yet practical enough to be used by the whole family.

**Satinjet®
WAIPORI HANDSET**

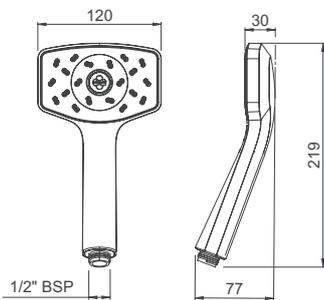

INLET CONNECTIONS:
1/2" BSP
WORKING PRESSURE:
0.35 - 5.0 bar

- Supplied with 9l/min flow regulator



water label	L/Min	9.0		
	L/Min	20.3		

WAHPCPUK Chrome & Graphite Ex.VAT £37.45 Inc.VAT £44.94

WAHSPWHUK Chrome & White Ex.VAT £37.45 Inc.VAT £44.94

**Satinjet®
WAIPORI SHOWER KIT**

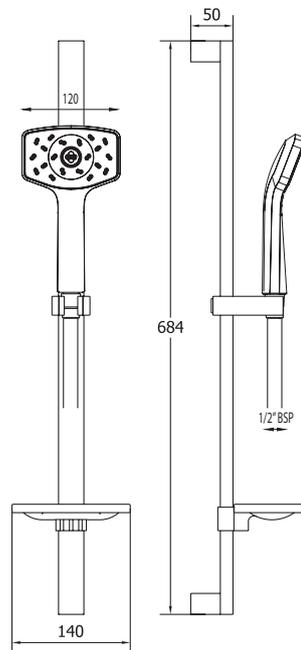

INLET CONNECTIONS:
1/2" BSP
WORKING PRESSURE:
0.35 - 5.0 bar

- Supplied with 9l/min flow regulator
- Smooth easy clean 1.5m hose



water label	L/Min	9.0		
	L/Min	20.3		

WK1 Chrome & Graphite Ex.VAT £61.80 Inc.VAT £74.16

Waipori offers a widespread Satinjet spray coverage for relaxation and cleansing. Curved edges and faces soften the geometric styling of Waipori, making it a modern and attractive alternative to square styles. The range is characterised by tapering lines, subtly rounded faces and distinctive arcs.



WIDE SPRAY

A well balanced wide spray that is pampering, yet practical enough to be used by the whole family.

Satinjet° WAIPORI SHOWER HEAD

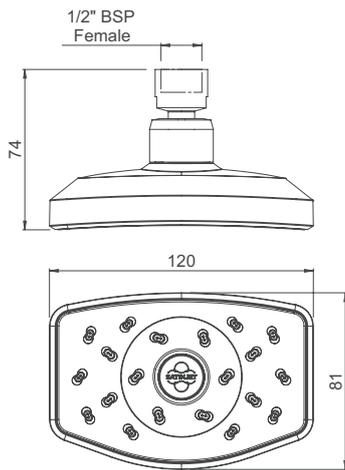

INLET CONNECTIONS:
1/2" BSP
WORKING PRESSURE:
0.35 – 5.0 bar

- Supplied with 9l/min flow regulator
- Swivel joint



water label	L/Min	9.0		
	L/Min	19.8		

WASRCPUK Chrome & Graphite

Ex.VAT £37.45 Inc.VAT £44.94

Satinjet° WAIPORI COOL TO TOUCH BAR SHOWER

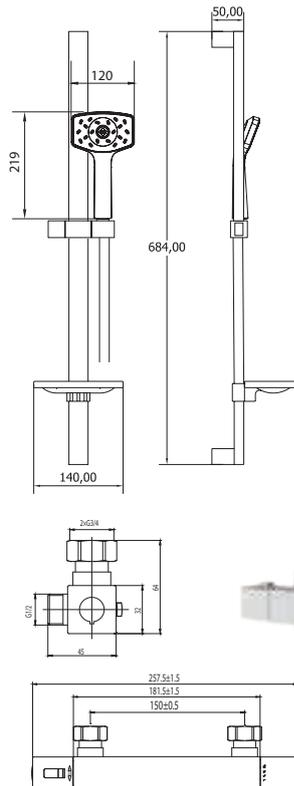

VALVE:
Thermostatic
OPERATION:
Separate flow and temperature controls
INLET CONNECTIONS:
15mm Compression
WORKING PRESSURE:
0.5 – 5.0 bar

- Safe cool to touch body
- 38°C temperature hot stop with override facility
- Smooth easy clean 1.5m hose
- Supplied with 9l/min flow regulator



water label	L/Min	9.0		
	L/Min	20.3		

WCTS Chrome & Graphite

Ex.VAT £176.97 Inc.VAT £212.36

Methven was founded in New Zealand in 1886 as a manufacturer of high quality brassware. Over the years we have learned a lot about water, how to treat this precious natural resource with care and harness its power to cleanse, calm, refresh and invigorate. Today, we are renowned for world-leading technology, beautiful design, and award winning showers, taps and valves. We continue our mission to create amazing water experiences for you.



Satinjet®
WAIPORI COOL TO TOUCH BAR SHOWER WITH DIVERTER



VALVE:
Thermostatic
OPERATION:
Separate flow and temperature controls
INLET CONNECTIONS:
15mm Compression
WORKING PRESSURE:
1.5 - 5.0 bar

- Safe cool to touch body
- 38°C temperature hot stop with override facility
- Integral diverter to fixed head and handset
- Smooth easy clean 1.5m hose
- Supplied with 9l/min flow regulator



water label	L/Min	9.0	✓
	L/Min	20.3	✗

WCTSDEF Chrome & Graphite Ex.VAT £454.92 Inc.VAT £545.90

METHVEN
Satinjet®

A sensation only your skin can truly understand.



Turn an everyday ritual into a shower experience with award-winning Satinjet® technology from Methven.

Unlike conventional showers, Satinjet® uses unique twin-jet technology to create optimum water droplet size and pressure, with over 300,000 droplets per second. The result is an immersive, full-body shower sensation that transforms your regular shower into an experience like no other.



Fusing product functionality with architectural design, the Kiri range makes a statement with its crisp, sleek and modern design. Smooth beveled edges intersect with rectangular and circular forms to give Kiri its characteristic design signature. Featuring award winning Satinjet technology, the Kiri range delivers a superior, rejuvenating shower experience.

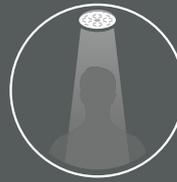

REGULAR SPRAY WIDTH

A powerful and direct spray, making you feel alive and full of energy – great for everyday showering.

Satinjet® KIRI HANDSET



INLET CONNECTIONS:
1/2" BSP
WORKING PRESSURE:
0.35 – 5.0 bar

- Supplied with 9l/min flow regulator



SJK23 Chrome & Graphite

Ex.VAT £28.09 Inc.VAT £33.71

Satinjet® KIRI LOW FLOW HANDSET

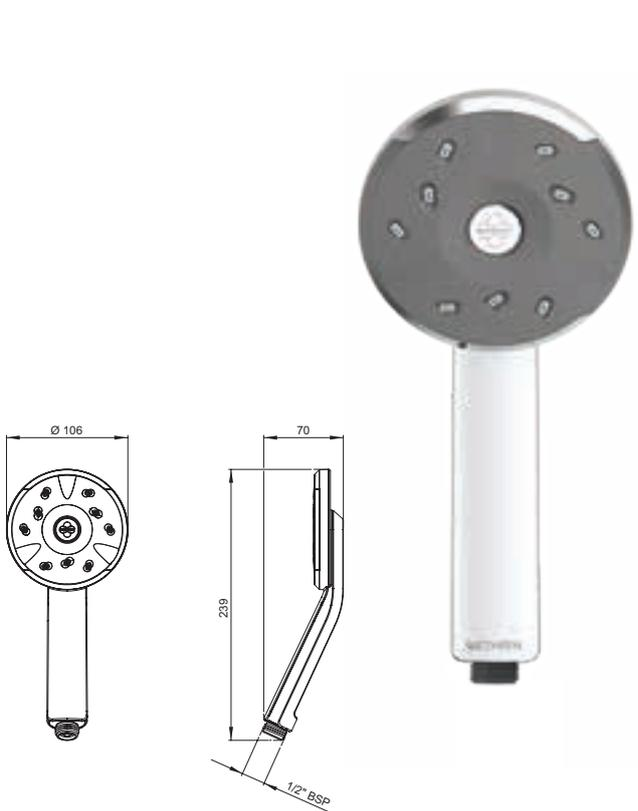

INLET CONNECTIONS:
1/2" BSP
WORKING PRESSURE:
1.0 – 5.0 bar

- Delivers a great shower at a lower flow rate



SJK23-LF Chrome & Graphite

Ex.VAT £28.09 Inc.VAT £33.71

Methven was founded in New Zealand in 1886 as a manufacturer of high quality brassware. Over the years we have learned a lot about water, how to treat this precious natural resource with care and harness its power to cleanse, calm, refresh and invigorate. Today, we are renowned for world-leading technology, beautiful design, and award winning showers, taps and valves. We continue our mission to create amazing water experiences for you.



Satinjet® KIRI SHOWER KIT

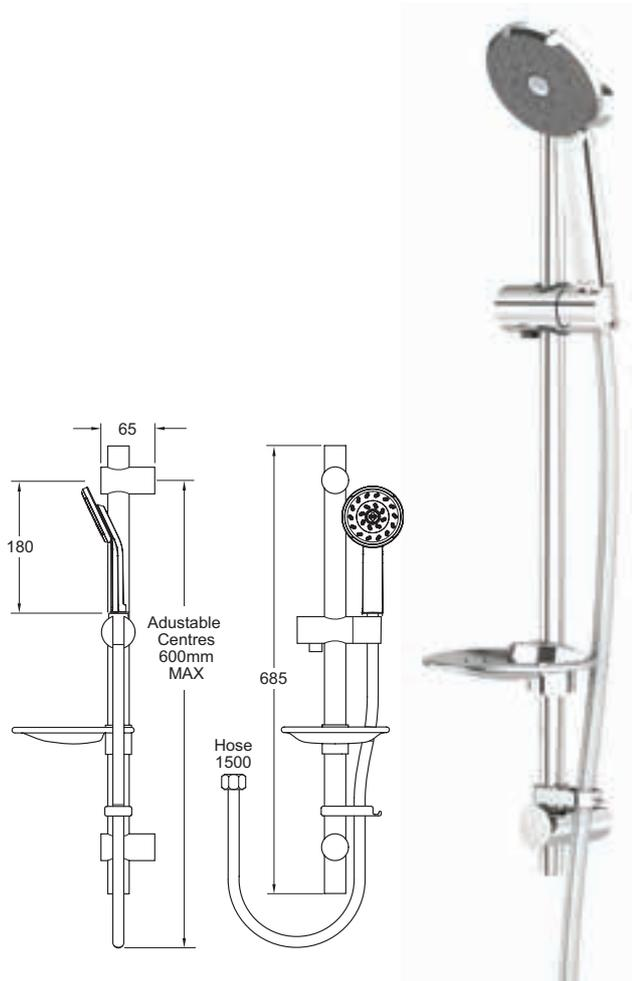

INLET CONNECTIONS:
1/2" BSP
WORKING PRESSURE:
0.35 - 5.0 bar

- Riser rail features adjustable brackets - ideal for retrofit
- Smooth easy clean 1.5m hose
- Supplied with 9l/min flow regulator



water label	L/Min	9.0	✓
	L/Min	22.5	✗

KK1 Chrome & Graphite

Ex.VAT £55.25 Inc.VAT £66.30

Satinjet® KIRI SHOWER HEAD



INLET CONNECTIONS:
1/2" BSP
WORKING PRESSURE:
0.35 - 5.0 bar

- Swivel joint
- Supplied with 9l/min flow regulator



water label	L/Min	9.0	✓
	L/Min	22.0	✗

SJK005 Chrome & Graphite

Ex.VAT £28.09 Inc.VAT £33.71

Fusing product functionality with architectural design, the Kiri range makes a statement with its crisp, sleek and modern design. Smooth beveled edges intersect with rectangular and circular forms to give Kiri its characteristic design signature. Featuring award winning Satinjet technology, the Kiri range delivers a superior, rejuvenating shower experience.



REGULAR SPRAY WIDTH

A powerful and direct spray, making you feel alive and full of energy – great for everyday showering.

Satinjet® KIRI LOW FLOW SHOWER HEAD

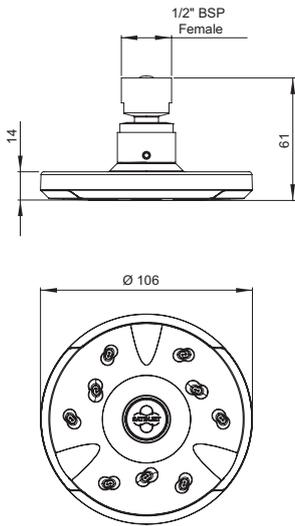

INLET CONNECTIONS:
1/2" BSP

WORKING PRESSURE:
1.0 – 5.0 bar

- Swivel joint
- Delivers a great shower at a lower flow rate



SJK005-LF Chrome & Graphite Ex.VAT £28.09 Inc.VAT £33.71

Satinjet® KIRI SATINJET® WALL MOUNTED SHOWERHEAD

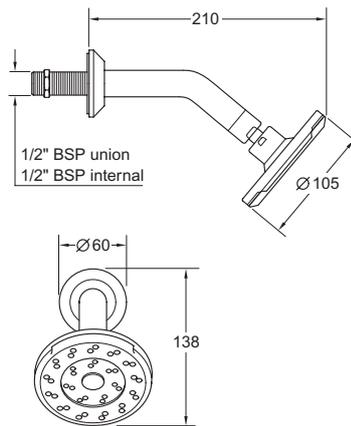

INLET CONNECTIONS:
1/2" BSP

WORKING PRESSURE:
0.35 – 5.0 bar

- Swivel joint
- Supplied with 9 l/min flow regulator



SJK 002 Chrome & Graphite Ex.VAT £55.25 Inc.VAT £66.30

Methven was founded in New Zealand in 1886 as a manufacturer of high quality brassware. Over the years we have learned a lot about water, how to treat this precious natural resource with care and harness its power to cleanse, calm, refresh and invigorate. Today, we are renowned for world-leading technology, beautiful design, and award winning showers, taps and valves. We continue our mission to create amazing water experiences for you.



KIRI CONCEALED MIXER VALVE (SINGLE OUTLET)



KIRI 1VA Chrome (ABS plate)

KIRI 1V Chrome (Brass plate)

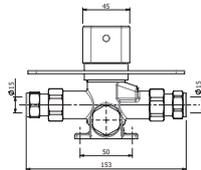
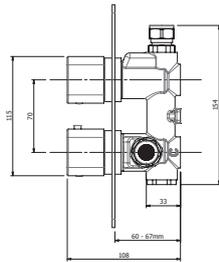
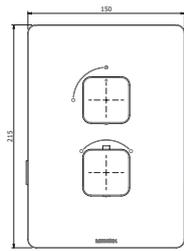
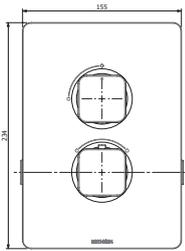

KIRI CONCEALED MIXER VALVE (2 OUTLETS)



KIRI 2VDIVA Chrome (ABS plate) KIRI 2VDIV Chrome (Brass plate)

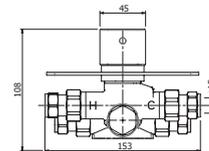
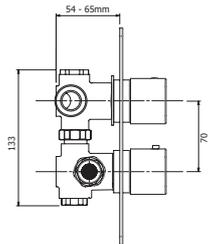
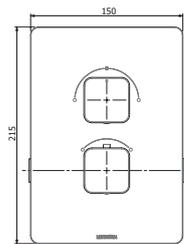
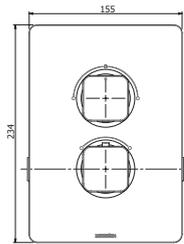

VALVE:
Thermostatic
OPERATION:
Separate flow and temperature controls
INLET CONNECTIONS:
15mm Compression
WORKING PRESSURE:
0.2 – 5.0 bar

- 38°C temperature hot stop with override facility
- Available with brass or ABS concealing plate
- Concealed shower spindle extension available see page 160

VALVE:
Thermostatic
OPERATION:
Separate flow and temperature controls
INLET CONNECTIONS:
15mm Compression
WORKING PRESSURE:
0.5 – 5.0 bar

- Diverter cartridge to two outlets
- 38°C temperature hot stop with override facility
- Available with brass or ABS concealing plate
- Concealed shower spindle extension available see page 160



water label	L/Min	14.0	✓
	L/Min	34.0	✗

KIRI 1V Chrome (Brass plate)

Ex.VAT £279.97 Inc.VAT £335.96

KIRI 1VA Chrome (ABS plate)

Ex.VAT £235.80 Inc.VAT £282.96



water label	L/Min	14.0	✓
	L/Min	30.5	✗

KIRI 2VDIV Chrome (Brass plate)

Ex.VAT £326.78 Inc.VAT £392.14

KIRI 2VDIVA Chrome (ABS plate)

Ex.VAT £282.61 Inc.VAT £339.13

Fusing product functionality with architectural design, the Kiri range makes a statement with its crisp, sleek and modern design. Smooth beveled edges intersect with rectangular and circular forms to give Kiri its characteristic design signature. Featuring award winning Satinjet technology, the Kiri range delivers a superior, rejuvenating shower experience.



REGULAR SPRAY WIDTH

A powerful and direct spray, making you feel alive and full of energy – great for everyday showering.

KIRI CONCEALED MIXER VALVE (3 OUTLETS)



KIRI 3VDIVA Chrome (ABS)

KIRI 3VDIV Chrome (Brass)

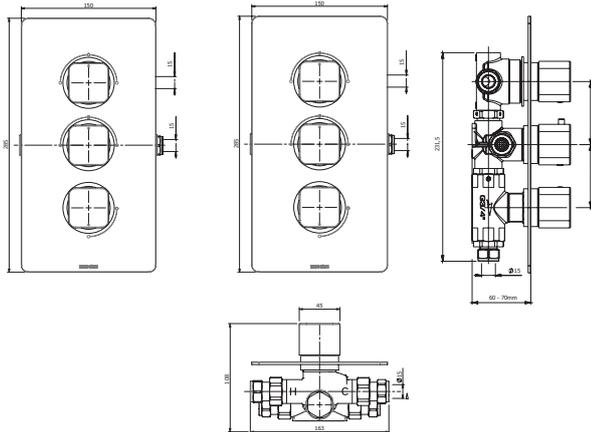

VALVE:

Thermostatic

OPERATION:

Separate flow and temperature controls

INLET CONNECTIONS:

15mm Compression

WORKING PRESSURE:

1.0 – 5.0 bar

- Diverter cartridge to two outlets and separate stopcock for bathfill
- 38°C temperature hot stop with override facility
- Available with brass or ABS concealing plate
- Concealed shower spindle extension available see page 160



water label	L/Min	20.0		
	L/Min	32.0		

KIRI 3VDIV Chrome (Brass)

Ex.VAT £420.42 Inc.VAT £504.50

KIRI 3VDIVA Chrome (ABS plate)

Ex.VAT £376.25 Inc.VAT £451.50

Satinjet®

KIRI SHOWER POLE WITH DIVERTER FROM FIXED HEAD TO HANDSET

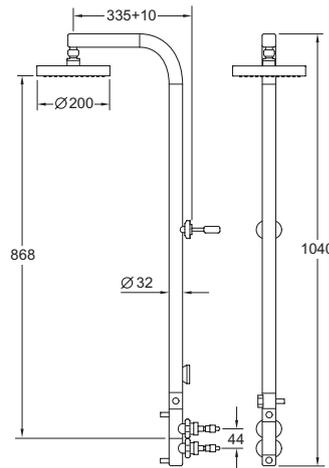

VALVE:

Thermostatic

OPERATION:

Separate flow and temperature controls

INLET CONNECTIONS:

15mm Compression

WORKING PRESSURE:

1.0 – 5.0 bar

- Integral thermostatic valve with 38°C hot stop with override facility
- Smooth easy clean 1.5m hose
- Satinjet Fixed head and handset both supplied with 9l/min flow regulator



KIRI SPDIV Chrome & Graphite

Ex.VAT £607.68 Inc.VAT £729.22



Methven was founded in New Zealand in 1886 as a manufacturer of high quality brassware. Over the years we have learned a lot about water, how to treat this precious natural resource with care and harness its power to cleanse, calm, refresh and invigorate. Today, we are renowned for world-leading technology, beautiful design, and award winning showers, taps and valves. We continue our mission to create amazing water experiences for you.



Satinjet®

KIRI COOL TO TOUCH BAR SHOWER WITH DIVERTER



VALVE:
Thermostatic
OPERATION:
Separate flow and temperature controls
INLET CONNECTIONS:
15mm Compression
WORKING PRESSURE:
1.5 - 5.0 bar

- Diverter to two outlets
- Safe cool to touch body
- 38°C hot stop with override facility
- Satinjet Fixed head and handset both supplied with 9l/min flow regulator
- Includes easy fit connections
- Smooth easy clean 1.5m hose



KCTSDEF Chrome & Graphite

Ex.VAT £373.60 Inc.VAT £448.32

Satinjet®

KIRI COOL TO TOUCH BAR SHOWER



VALVE:
Thermostatic
OPERATION:
Separate flow and temperature controls
INLET CONNECTIONS:
15mm Compression
WORKING PRESSURE:
0.5 - 5.0 bar

- Safe cool to touch body
- 38°C hot stop with override facility
- Eco flow control with override facility
- Includes easy fit connections
- Easy to use handset slider
- Includes Kiri Satinjet handset
- Smooth easy clean 1.5 metre hose
- Supplied with 9l/min flow regulator



KCTS Chrome & Graphite

Ex.VAT £186.33 Inc.VAT £223.60



Methven was founded in New Zealand in 1886 as a manufacturer of high quality brassware. Over the years we have learned a lot about water, how to treat this precious natural resource with care and harness its power to cleanse, calm, refresh and invigorate. Today, we are renowned for world-leading technology, beautiful design, and award winning showers, taps and valves. We continue our mission to create amazing water experiences for you.

Satinjet®

KIRI SEQUENTIAL VALVE & KIT

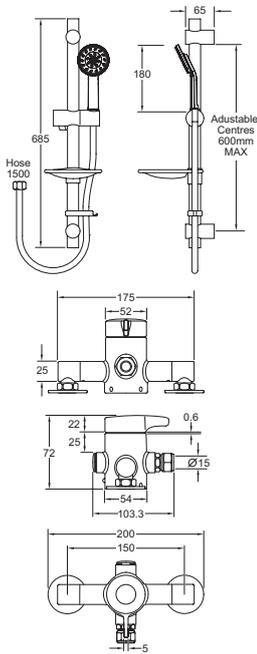

VALVE:
Thermostatic

OPERATION:
Sequential Control

INLET CONNECTIONS:
15mm Compression

WORKING PRESSURE:
0.35 - 5.0 bar

- Riser rail features adjustable brackets - ideal for retrofit
- Smooth easy clean 1.5m hose
- Includes Kiri Satinjet handset
- Supplied with 9l/min flow regulator



water label	L/Min	9.0	✓
	L/Min	35.0	✗

KISSMCP Chrome & Graphite

Ex.VAT £214.42 Inc.VAT £257.30

METHVEN

Satinjet®

A sensation only
your skin can truly
understand.



Turn an everyday ritual into a shower experience with award-winning Satinjet® technology from Methven.

Unlike conventional showers, Satinjet® uses unique twin-jet technology to create optimum water droplet size and pressure, with over 300,000 droplets per second. The result is an immersive, full-body shower sensation that transforms your regular shower into an experience like no other.



The Maku shower range integrates distinctive smooth and compact design elements with award-winning Satinjet spray. Ideal for small showering spaces, Maku is an affordable and accessible option for any home.



REGULAR SPRAY WIDTH

A powerful and direct spray, making you feel alive and full of energy – great for everyday showering.



**Satinjet®
MAKU HANDSET**



INLET CONNECTIONS:
½" BSP
WORKING PRESSURE:
0.35 – 5.0 bar

- Suitable for all showers
- Ideal for use with electric showers
- Supplied with 9l/min flow regulator



water label	L/Min	9.0		
	L/Min	18.1		

MAHPCUK Chrome & Graphite Ex.VAT £23.40 Inc.VAT £28.08

**Satinjet®
MAKU SHOWER KIT**

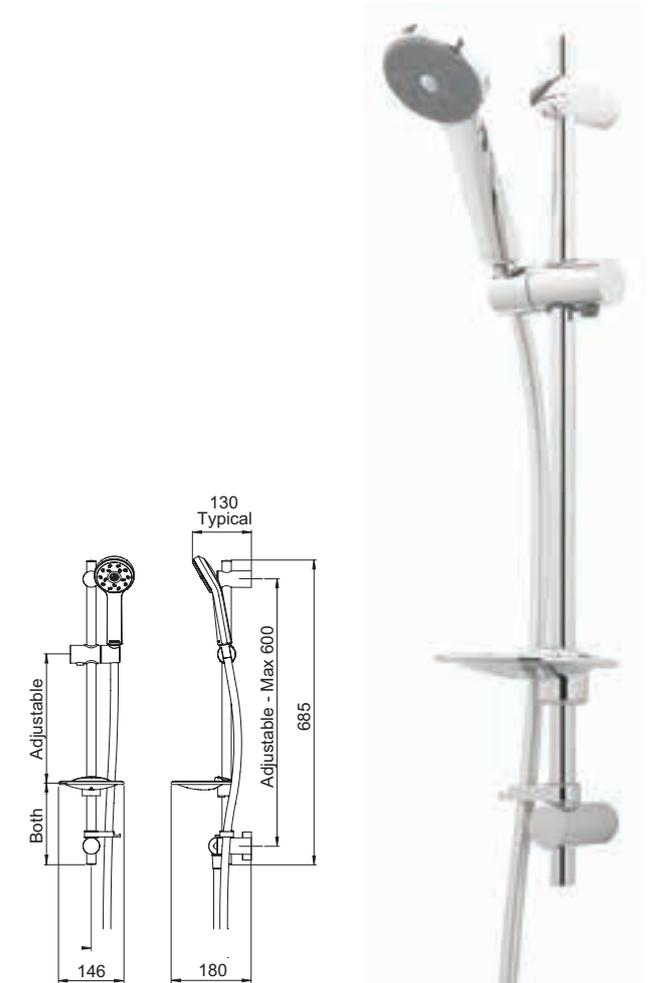

INLET CONNECTIONS:
½" BSP
WORKING PRESSURE:
0.35 – 5.0 bar

- Suitable for all showers
- Ideal for electric showers
- Riser rail features adjustable brackets – ideal for retrofit
- Smooth easy clean 1.5m hose
- Supplied with 9l/min flow regulator



water label	L/Min	9.0		
	L/Min	18.1		

MK1 Chrome & Graphite Ex.VAT £50.56 Inc.VAT £60.67

The Maku shower range integrates distinctive smooth and compact design elements with award-winning Satinjet spray. Ideal for small showering spaces, Maku is an affordable and accessible option for any home.



REGULAR SPRAY WIDTH

A powerful and direct spray, making you feel alive and full of energy – great for everyday showering.

Satinjet®

MAKU COOL TO TOUCH BAR SHOWER

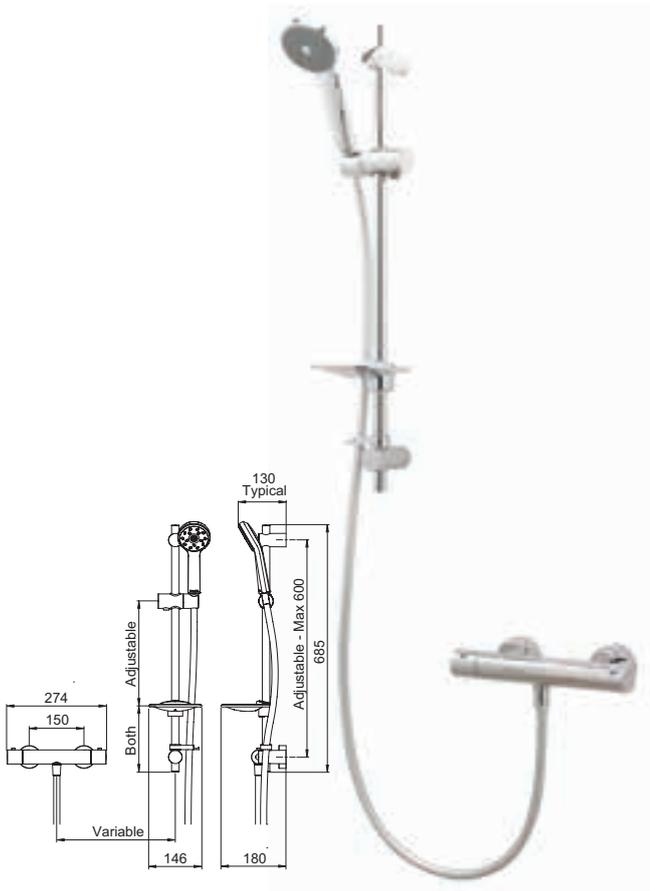

VALVE:
Thermostatic

OPERATION:
Separate flow and temperature controls

INLET CONNECTIONS:
15mm Compression

WORKING PRESSURE:
0.35 – 5.0 bar

- 38°C temperature hot stop with override facility
- Safe cool to touch body
- Eco flow control with override facility
- Includes easy fit connections
- Includes Maku Satinjet handset
- Riser rail features adjustable brackets – ideal for retrofit
- Supplied with 9l/min flow regulator



water label	L/Min	9.0	
	L/Min	18.1	

MCTS Chrome & Graphite

Ex.VAT £140.45 Inc.VAT £168.54

Satinjet®

KEA SEQUENTIAL VALVE & KIT



VALVE:
Thermostatic

OPERATION:
Sequential Control

INLET CONNECTIONS:
15mm Compression

WORKING PRESSURE:
0.35 – 5.0 bar

- Riser rail features adjustable brackets – ideal for retrofit
- Smooth easy clean 1.5m hose
- Includes Maku Satinjet handset
- Supplied with 9l/min flow regulator



water label	L/Min	9.0	
	L/Min	35.0	

KESSMCP Chrome & Graphite

Ex.VAT £205.06 Inc.VAT £246.07

Methven was founded in New Zealand in 1886 as a manufacturer of high quality brassware. Over the years we have learned a lot about water, how to treat this precious natural resource with care and harness its power to cleanse, calm, refresh and invigorate. Today, we are renowned for world-leading technology, beautiful design, and award winning showers, taps and valves. We continue our mission to create amazing water experiences for you.



SOL BAR SHOWER

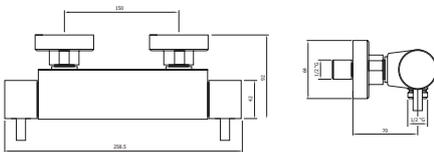

VALVE:
Thermostatic
OPERATION:
Separate flow and temperature controls
INLET CONNECTIONS:
15mm Compression
WORKING PRESSURE:
0.2 – 5.0 bar

- Ultimate thermostatic performance to TMV3 Buildcert standards
- Includes easy fit connections



SOLBEF Chrome

Ex.VAT £292.60 Inc.VAT £351.12

MICROPHONE HANDSET

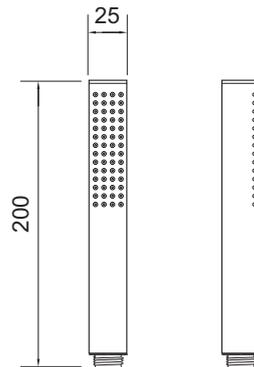

INLET CONNECTIONS:
1/2" BSP
WORKING PRESSURE:
0.35 – 5.0 bar

- Brass construction



MH1 Chrome

Ex.VAT £37.45 Inc.VAT £44.94

Designed to complement our Methven shower valves, create a bespoke showering system to suit any requirements.

Satinjet® ROUND FIXED HEAD SHOWER

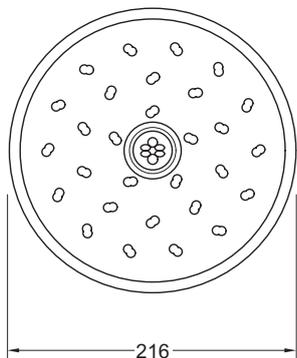
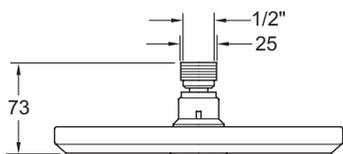

INLET CONNECTIONS:
1/2" BSP

WORKING PRESSURE:
0.35 – 5.0 bar

- Swivel joint
- Supplied with 9 l/min flow regulator



SJK 009 Chrome & Graphite

Ex.VAT £139.52 Inc.VAT £167.42

Satinjet® FLUSH MOUNTED CEILING SHOWER

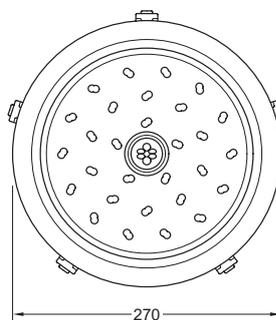
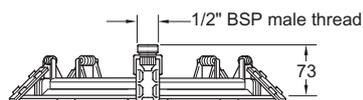

INLET CONNECTIONS:
1/2" BSP

WORKING PRESSURE:
0.35 – 5.0 bar

- Optimal installation height 2.1 – 2.2m (not suitable above 2.4m)
- Supplied with 9l/min flow limiter



SJK010 Chrome & Graphite

Ex.VAT £176.97 Inc.VAT £212.36



Methven was founded in New Zealand in 1886 as a manufacturer of high quality brassware. Over the years we have learned a lot about water, how to treat this precious natural resource with care and harness its power to cleanse, calm, refresh and invigorate. Today, we are renowned for world-leading technology, beautiful design, and award winning showers, taps and valves. We continue our mission to create amazing water experiences for you.



Satinjet® SQUARE FIXED HEAD SHOWER

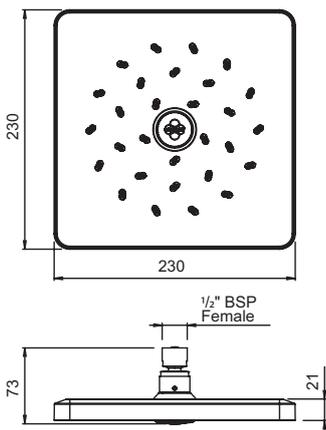

INLET CONNECTIONS:

1/2" BSP

WORKING PRESSURE:

0.35 - 5.0 bar

- Swivel joint
- Supplied with 9l/min flow limiter



OSQ230CP Chrome & Graphite

Ex.VAT **£139.52** Inc.VAT **£167.42**

OSQ230WHCPUK Chrome & White

Ex.VAT **£139.52** Inc.VAT **£167.42**

SLIM BRASS FIXED HEAD SHOWER

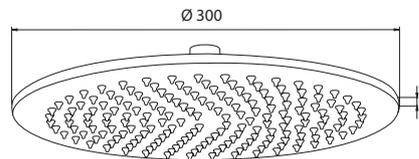

INLET CONNECTIONS:

1/2" BSP

WORKING PRESSURE:

0.5 - 5.0 bar

- Brass construction
- Swivel joint



MFH001 Chrome

Ex.VAT **£234.08** Inc.VAT **£280.90**

Designed to complement our Methven shower valves, create a bespoke showering system to suit any requirements.

SLIM BRASS FIXED HEAD SHOWER

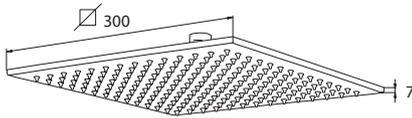

INLET CONNECTIONS:
1/2" BSP

WORKING PRESSURE:
0.5 – 5.0 bar

- Brass construction
- Swivel joint



MFH002 Chrome

Ex.VAT £271.54 Inc.VAT £325.85

METHVEN Airstream™

Welcome to softer, lighter,
more voluminous showering.



Welcome to Airstream from Methven.
A refreshing combination of air and
water that delivers a gentle, rain-like
feel to your showering.

EASY FIT SHOWER RAIL INSTALLATION GUIDE
IDEAL FOR RETRO-FIT – USE YOUR EXISTING
SHOWER RAIL HOLES



Methven was founded in New Zealand in 1886 as a manufacturer of high quality brassware. Over the years we have learned a lot about water, how to treat this precious natural resource with care and harness its power to cleanse, calm, refresh and invigorate. Today, we are renowned for world-leading technology, beautiful design, and award winning showers, taps and valves. We continue our mission to create amazing water experiences for you.



Airstream™

3 MODE EASY FIT SHOWER KIT

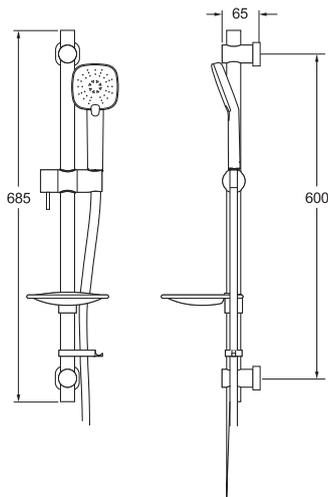

INLET CONNECTIONS:
½" BSP

WORKING PRESSURE:
0.5 – 5.0 bar

- Riser rail features easy fit adjustable brackets – ideal for retrofit
- Lever operation on slider adjustment
- Airstream technology mixes air with water to create a more voluminous spray
- Easy click 3 function spray
- Simple push button operation to change between Airstream full body, massage and combination spray



EKIT01/A Chrome/White

Ex.VAT £82.02 Inc.VAT £98.42

Airstream™

3 MODE EASY FIT SHOWER KIT

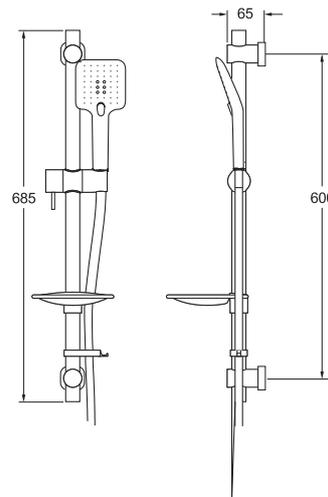

INLET CONNECTIONS:
½" BSP

WORKING PRESSURE:
0.5 – 5.0 bar

- Riser rail features easy fit adjustable brackets – ideal for retrofit
- Button operation on slider adjustment
- Airstream technology mixes air with water to create a more voluminous spray
- Easy click 3 function spray
- Simple push button operation to change between Airstream full body, massage and combination spray



EKIT02/A Chrome

Ex.VAT £73.18 Inc.VAT £87.82

Designed to complement our Methven shower valves, create a bespoke showering system to suit any requirements.

Airstream™ 3 MODE EASY FIT SHOWER KIT

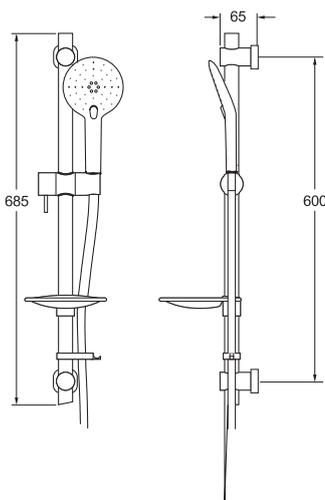

INLET CONNECTIONS:
1/2" BSP

WORKING PRESSURE:
0.5 - 5.0 bar

- Riser rail features easy fit adjustable brackets - ideal for retrofit
- Button operation on slider adjustment
- Airstream technology mixes air with water to create a more voluminous spray
- Easy click 3 function spray
- Simple push button operation to change between Airstream full body, massage and combination spray



EKIT03/A Chrome

Ex.VAT £73.18 Inc.VAT £87.82

EDGE SHOWER RAIL

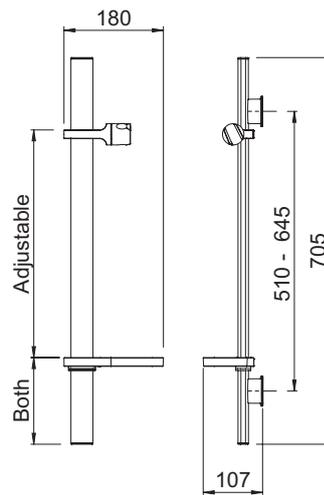

- Riser rail features adjustable brackets - ideal for retrofit

EDGERAIL705 Chrome

Ex.VAT £93.63 Inc.VAT £112.36



Methven was founded in New Zealand in 1886 as a manufacturer of high quality brassware. Over the years we have learned a lot about water, how to treat this precious natural resource with care and harness its power to cleanse, calm, refresh and invigorate. Today, we are renowned for world-leading technology, beautiful design, and award winning showers, taps and valves. We continue our mission to create amazing water experiences for you.



KIRI SHOWER RAIL

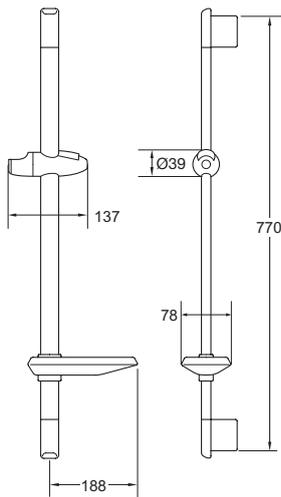

Satinjet® SATINJET RAIL SYSTEM

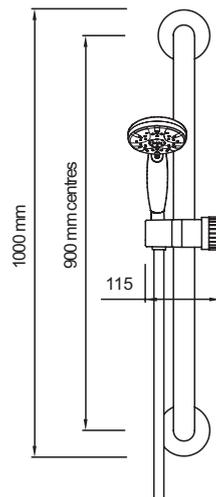

INLET CONNECTIONS:
1/2" BSP

WORKING PRESSURE:
0.35 – 5.0 bar

- Includes Kiri Satinjet handset
- 2m easy clean smooth hose
- Supplied with 9l/min flow regulator
- Can be used as a grab bar

KSR004 Chrome Ex.VAT £74.91 Inc.VAT £89.89

PHK1 Chrome & Graphite Ex.VAT £111.43 Inc.VAT £133.72



Designed to complement our Methven shower valves, create a bespoke showering system to suit any requirements.

CEILING SHOWER ARM

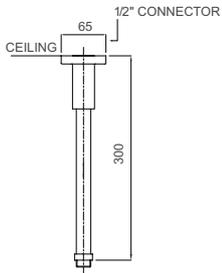

INLET CONNECTIONS:
1/2" BSP

- Brass construction
- Comes complete with 1/2" BSP connection

SAC290 Chrome

Ex.VAT **£56.18** Inc.VAT **£67.42**

WALL-MOUNTED SHOWER ARM

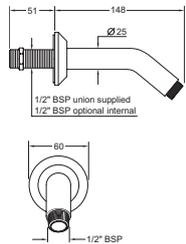

INLET CONNECTIONS:
1/2" BSP

- Brass construction
- Comes complete with 1/2" BSP connection

SAW148 Chrome

Ex.VAT **£28.09** Inc.VAT **£33.71**

OVER HEAD WALL SHOWER ARM

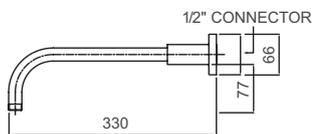

INLET CONNECTIONS:
1/2" BSP

- Brass construction
- Comes complete with 1/2" BSP connection

SAW320 Chrome

Ex.VAT **£28.09** Inc.VAT **£33.71**

ROUND WALL UNION

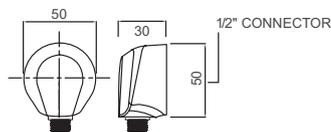

INLET CONNECTIONS:
1/2" BSP

- Brass construction
- Comes complete with 1/2" BSP connection

WUR Chrome

Ex.VAT **£51.49** Inc.VAT **£61.79**

SQUARE WALL UNION

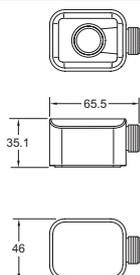

INLET CONNECTIONS:
1/2" BSP

- Brass construction
- Comes complete with 1/2" BSP connection

METHSQELB Chrome

Ex.VAT **£51.49** Inc.VAT **£61.79**



Methven was founded in New Zealand in 1886 as a manufacturer of high quality brassware. Over the years we have learned a lot about water, how to treat this precious natural resource with care and harness its power to cleanse, calm, refresh and invigorate. Today, we are renowned for world-leading technology, beautiful design, and award winning showers, taps and valves. We continue our mission to create amazing water experiences for you.



ROUND PARKING BRACKET

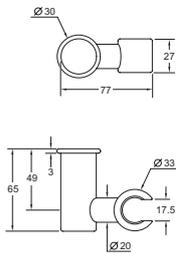

- Brass construction

RPB Chrome

Ex.VAT £46.82 Inc.VAT £56.18

SQUARE PARKING BRACKET

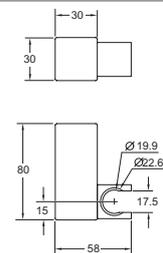

- Brass construction

SPB Chrome

Ex.VAT £46.82 Inc.VAT £56.18

WALL OUTLET BRACKET

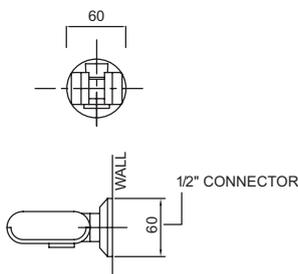

INLET CONNECTIONS:
1/2" BSP

- Brass construction
- Built-in check valve
- Handset locking holder with key
- Comes complete with 1/2" BSP connection

WOB Chrome

Ex.VAT £56.18 Inc.VAT £67.42

SMOOTH SHOWER HOSE 1.5M

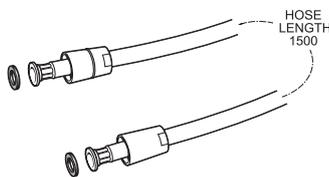

INLET CONNECTIONS:
1/2" BSP

- Smooth easy clean 1.5m hose



HOS1.5PVS07 Chrome

Ex.VAT £25.37 Inc.VAT £30.44

AIO BASIN MIXER

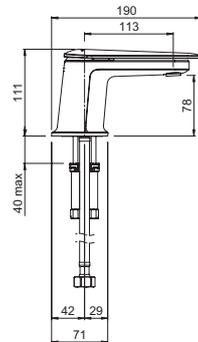

INLET CONNECTIONS:

1/2" BSP

WORKING PRESSURE:

0.35 - 5.0 bar

- Lead free Eco Brass*
- Ceramic cartridge
- Cushion close
- Slim stream aerator with directional swivel
- Twin stud clamp kit



water label L/Min **7.9**

AOBCPUK Chrome

Ex.VAT £173.23 Inc.VAT £207.88

AIO MINI BASIN MIXER

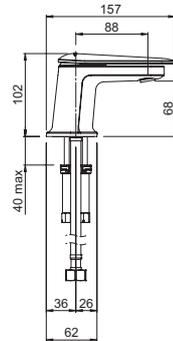

INLET CONNECTIONS:

1/2" BSP

WORKING PRESSURE:

0.35 - 5.0 bar

- Lead free Eco Brass**
- Ceramic cartridge
- Cushion close
- Slim stream aerator with directional swivel
- Twin stud clamp kit



water label L/Min **6.6**

AOBMCPUK Chrome

Ex.VAT £149.81 Inc.VAT £179.77

AIO BATH FILLER

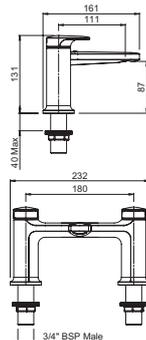

INLET CONNECTIONS:

3/4" BSP

WORKING PRESSURE:

0.35 - 5.0 bar

- Lead free Eco Brass*
- 110mm spout - suits a wide range of bath specifications



water label L/Min **7.9**

AOBFPUK Chrome

Ex.VAT £234.08 Inc.VAT £280.90

AIO BATH SHOWER MIXER

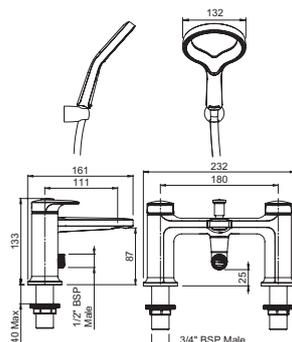

INLET CONNECTIONS:

3/4" BSP

WORKING PRESSURE:

1.0 - 5.0 bar

- Includes Aurajet Aio handset
- Lead free Eco Brass*
- Limescale resistant handset
- 110mm spout - suits a wide range of bath specifications
- Water efficient without compromising showering performance



water label L/Min **9.0**

AOBSMCPUK Chrome

Ex.VAT £279.97 Inc.VAT £335.96

AOBSMCPWHUK Chrome & White

Ex.VAT £279.97 Inc.VAT £335.96



A classic form with modern design accents, the Kaha collection brings a distinctive design look to any home. Organic curves meet crisp edges to create a timeless look that's as practical as it is beautiful.



KAHA BASIN MIXER WITH SWIVEL BASE

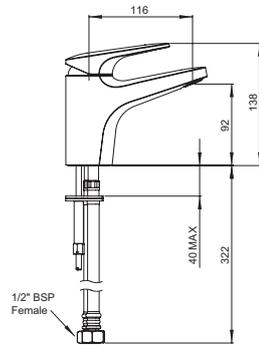

INLET CONNECTIONS:
1/2" BSP
WORKING PRESSURE:
0.35 – 5.0 bar

- Ceramic cartridge
- Swivel spout
- Slim stream aerator with directional swivel
- Optional base trim ring on spout



water label L/Min **7.0**

KAHA 113 Chrome

Ex.VAT £163.85 Inc.VAT £196.62

KAHA 3 HOLE DECK-MOUNTED BASIN MIXER

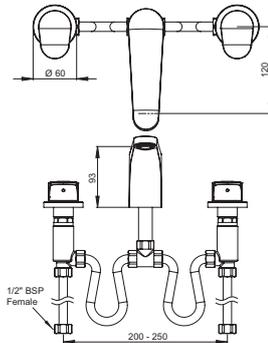

INLET CONNECTIONS:
1/2" BSP
WORKING PRESSURE:
0.35 – 5.0 bar

- Slim stream aerator with directional swivel



water label L/Min **7.0**

KAHA 111 Chrome

Ex.VAT £210.68 Inc.VAT £252.82

KAHA 3 HOLE DECK-MOUNTED BATH MIXER

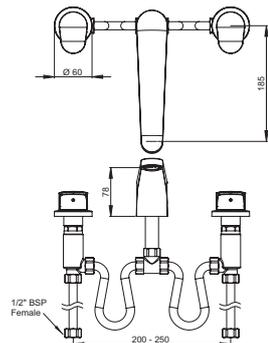

INLET CONNECTIONS:
1/2" BSP
WORKING PRESSURE:
0.35 – 5.0 bar

- Slim stream aerator with directional swivel



KAHA 134 Chrome

Ex.VAT £234.08 Inc.VAT £280.90

KAHA BATH WALL SPOUT

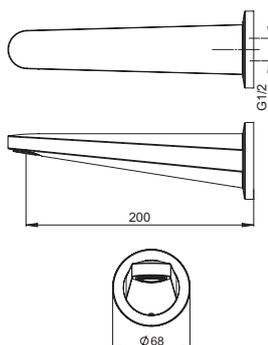

INLET CONNECTIONS:
1/2" BSP
WORKING PRESSURE:
0.35 – 5.0 bar

- Slim stream aerator with directional swivel
- Quick fit adaptor for hassle free installation
- Comes complete with 15mm (1/2" BSP) threaded connection
- Ideal for use with Kaha concealed valves



KASP200CPUK Chrome

Ex.VAT £102.06 Inc.VAT £122.47

In our distinctive Waipori collection, we have taken traditional geometric shapes and subtly tapered them for the modern bathroom. Attractive, slimline and compact.

WAIPORI BASIN MIXER

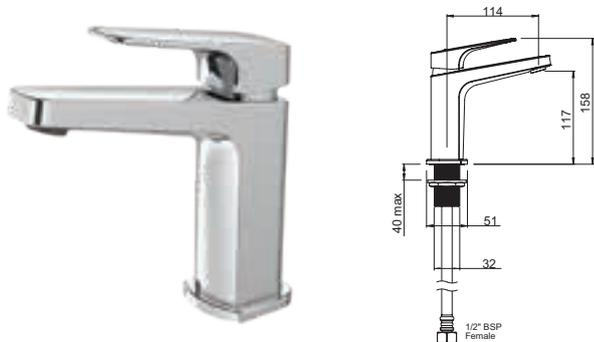

INLET CONNECTIONS:
1/2" BSP

WORKING PRESSURE:
0.35 - 5.0 bar

- Ceramic cartridge
- Slim stream aerator with directional swivel



water label L/Min 7.0

WABCPUK Chrome

Ex.VAT £163.85 Inc.VAT £196.62

WAIPORI 3 HOLE DECK MOUNTED BASIN MIXER

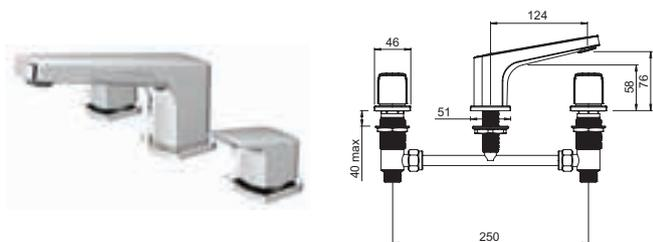

INLET CONNECTIONS:
1/2" BSP

WORKING PRESSURE:
0.35 - 5.0 bar

- Slim stream aerator with directional swivel



WABSCPUK Chrome

Ex.VAT £210.68 Inc.VAT £252.82

WAIPORI 3 HOLE DECK MOUNTED BATH MIXER

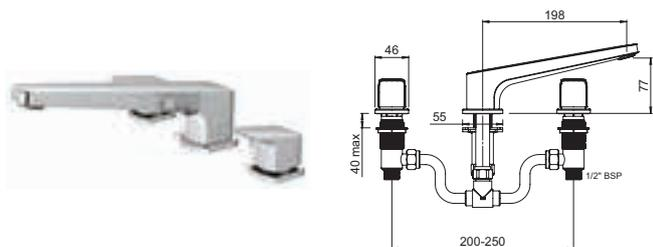

INLET CONNECTIONS:
1/2" BSP

WORKING PRESSURE:
0.35 - 5.0 bar

- Slim stream aerator with directional swivel



WABHCPUK Chrome

Ex.VAT £234.08 Inc.VAT £280.90

WAIPORI DECK MOUNTED SWIVEL BATH SPOUT

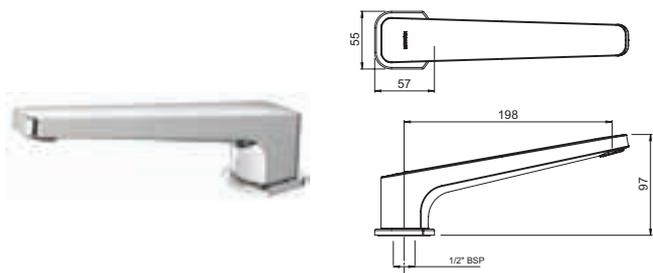

INLET CONNECTIONS:
1/2" BSP

WORKING PRESSURE:
0.35 - 5.0 bar

- Slim stream aerator with directional swivel
- Swivel spout



WASPH200CPUK Chrome

Ex.VAT £121.72 Inc.VAT £146.06



Kiri is our answer for lovers of clean lines and strong, dynamic forms. This solid architectural style makes its presence known in your bathroom.



KIRI BASIN MIXER

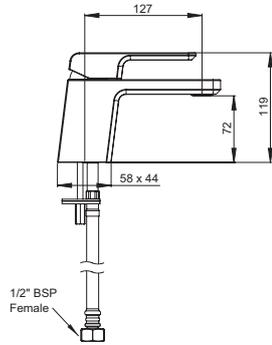

INLET CONNECTIONS:
1/2" BSP
WORKING PRESSURE:
0.35 – 5.0 bar

- Ceramic cartridge
- Slim stream aerator with directional swivel



water label L/Min **7.0**

KIRI 113 Chrome

Ex.VAT **£163.85** Inc.VAT **£196.62**

KIRI 3 HOLE DECK MOUNTED BASIN MIXER

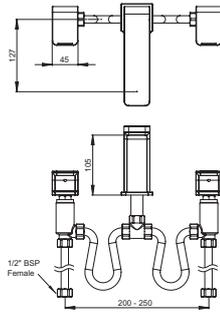

INLET CONNECTIONS:
1/2" BSP
WORKING PRESSURE:
0.35 – 5.0 bar

- Slim stream aerator with directional swivel



KIRI 111 Chrome

Ex.VAT **£210.68** Inc.VAT **£252.82**

KIRI BATH WALL SPOUT

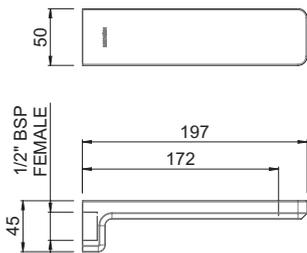

INLET CONNECTIONS:
1/2" BSP
WORKING PRESSURE:
0.35 – 5.0 bar

- Slim stream aerator with directional swivel
- Comes complete with 15mm (1/2" BSP) threaded connection
- Ideal for use with Kiri Concealed Valves



KISP172CPUK Chrome

Ex.VAT **£102.06** Inc.VAT **£122.47**

Satinjet®

KIRI LEVER THERMOSTATIC PILLAR MOUNTED BATH SHOWER MIXER

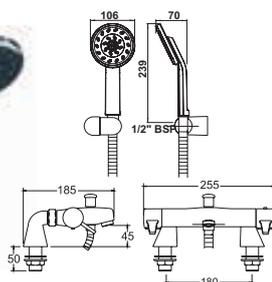

VALVE:
Thermostatic
OPERATION:
Separate flow and temperature controls
INLET CONNECTIONS:
3/4" BSP
WORKING PRESSURE:
1.0 – 5.0 bar

- TMV2 approved valve
- Thermostatic valve with 38°C temperature stop (with override)
- Complete with Kiri Satinjet handset & wall bracket
- Supplied with 9l/min flow regulator



water label L/Min **9.0** L/Min **22.5**

KLTV106 Chrome

Ex.VAT **£296.80** Inc.VAT **£356.16**

Kiri is our answer for lovers of clean lines and strong, dynamic forms. This solid architectural style makes its presence known in your bathroom.

Satinjet°

KIRI LEVER THERMOSTATIC PILLAR MOUNTED BATH SHOWER MIXER

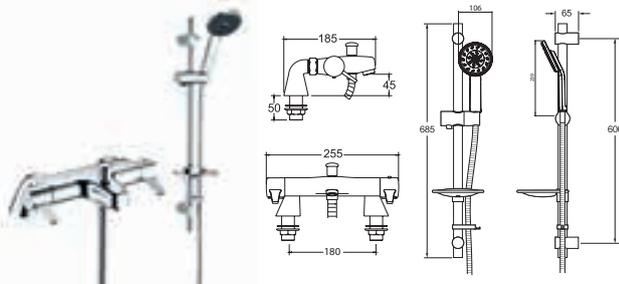

VALVE:

Thermostatic

OPERATION:

Separate flow and temperature controls

INLET CONNECTIONS:

3/4" BSP

WORKING PRESSURE: 1.0 – 5.0 bar



KLTV106/2BK Chrome

- TMV2 approved valve
- Thermostatic valve with 38°C temperature stop (with override)
- Complete with Kiri Satinjet handset, rail & 2 metre hose
- Supplied with 9l/min flow regulator

water label	L/Min	9.0		
	L/Min	22.5		

Ex.VAT £345.56 Inc.VAT £414.67

Satinjet°

KIRI THERMOSTATIC PILLAR MOUNTED BATH SHOWER MIXER

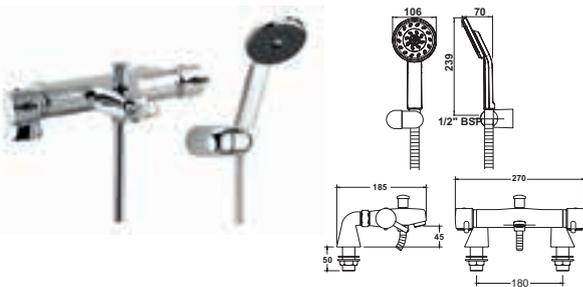

VALVE:

Thermostatic

OPERATION:

Separate flow and temperature controls

INLET CONNECTIONS:

3/4" BSP

WORKING PRESSURE: 1.0 – 5.0 bar



TLV106 Chrome

- TMV2 approved valve
- Thermostatic valve with 38°C temperature stop (with override)
- Complete with Kiri Satinjet handset & wall bracket
- Supplied with 9l/min flow regulator

water label	L/Min	9.0		
	L/Min	22.5		

Ex.VAT £284.92 Inc.VAT £341.90

Satinjet°

KIRI THERMOSTATIC PILLAR MOUNTED BATH SHOWER MIXER

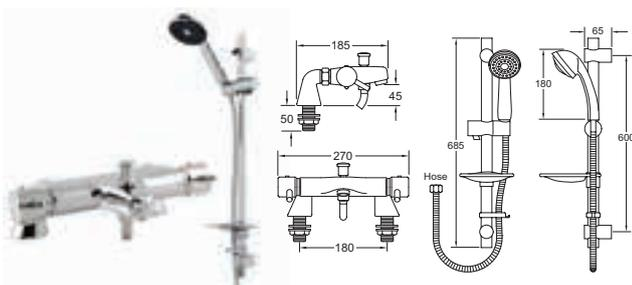

VALVE:

Thermostatic

OPERATION:

Separate flow and temperature controls

INLET CONNECTIONS:

3/4" BSP

WORKING PRESSURE: 1.0 – 5.0 bar



SHTLV106/2BK Chrome

- TMV2 approved valve
- Thermostatic valve with 38°C temperature stop (with override)
- Complete with Kiri Satinjet handset, rail & 2 metre hose
- Supplied with 9l/min flow regulator

water label	L/Min	9.0		
	L/Min	22.5		

Ex.VAT £336.15 Inc.VAT £403.38

Satinjet°

KIRI THERMOSTATIC WALL MOUNTED BATH SHOWER MIXER

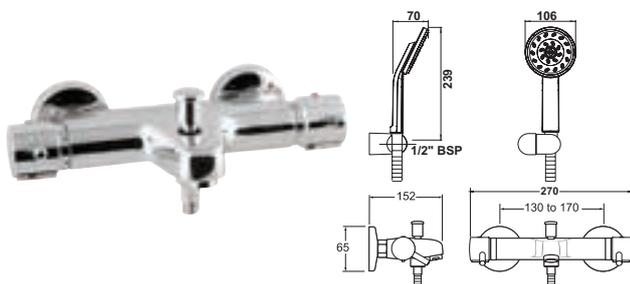

VALVE:

Thermostatic

OPERATION:

Separate flow and temperature controls

INLET CONNECTIONS:

3/4" BSP

WORKING PRESSURE: 1.0 – 5.0 bar



TLV106WM Chrome

- TMV2 approved valve
- Thermostatic valve with 38°C temperature stop (with override)
- Complete with Kiri Satinjet handset & wall bracket
- Supplied with 9l/min flow regulator

water label	L/Min	9.0		
	L/Min	22.5		

Ex.VAT £284.92 Inc.VAT £341.90



KIRI LEVER PILLAR TAPS

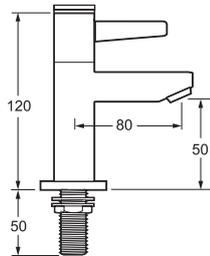

INLET CONNECTIONS:

1/2" BSP

WORKING PRESSURE:

0.2 - 5.0 bar

- Easy to use lever handles



KLTV106/2BK Chrome

Ex.VAT £84.80 Inc.VAT £101.76

METHVEN

Satinjet®

Kiri Lever Thermostatic Pillar Mounted Bath Shower Mixer

KLTV106/2BK



- New easy to use lever handle
- Thermostatic valve with 38°C temperature hot stop (with override)
- Complete with Kiri Satinjet® handset, rail & 2 metre hose
- Metal back nuts
- 1/2 turn CD valves
- Supplied with 9l/min flow regulator
- Working pressure 1.0 – 5.0 bar
- KLTV106 version – complete with handset & wall bracket



Combining crisp edges and soft curves, Kea brings a distinct touch of timeless elegance to baths, basins and showers. Its strong lines are beautifully offset by a tactile easy to use lever handle.

KEA MONO BASIN MIXER

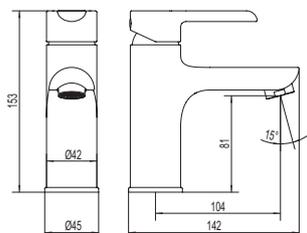

INLET CONNECTIONS:
1/2" BSP

WORKING PRESSURE:
0.2 – 5.0 bar

- Ceramic cartridge
- Slim stream aerator with directional swivel
- Includes 7 l/min flow regulator fitted
- Includes clicker waste



KEBCPUK Chrome

Ex.VAT £102.06 Inc.VAT £122.47

KEA MINI BASIN MIXER

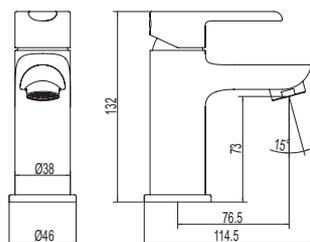

INLET CONNECTIONS:
1/2" BSP

WORKING PRESSURE:
0.5 – 5.0 bar

- Ceramic cartridge
- Slim stream aerator with directional swivel



KEBMCPK Chrome

Ex.VAT £92.70 Inc.VAT £111.24

KEA BASIN PILLAR TAPS

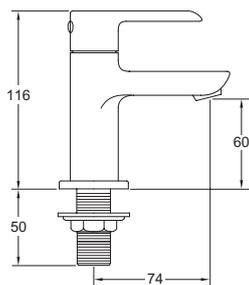

INLET CONNECTIONS:
1/2" BSP

WORKING PRESSURE:
0.1 – 5.0 bar



KETBCPUK Chrome

Ex.VAT £92.70 Inc.VAT £111.24

KEA BATH PILLAR TAPS

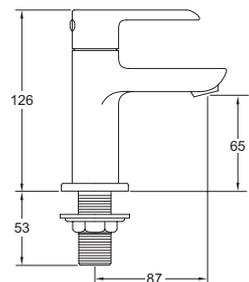

INLET CONNECTIONS:
3/4" BSP

WORKING PRESSURE:
0.3 – 5.0 bar



KETBTCPUK Chrome

Ex.VAT £102.06 Inc.VAT £122.47





KEA BATH FILLER

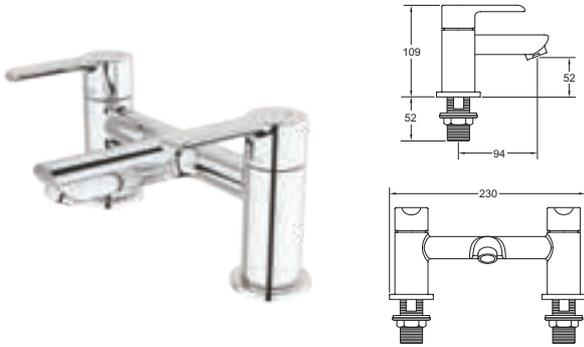

INLET CONNECTIONS:
3/4" BSP
WORKING PRESSURE:
0.3 – 5.0 bar



KEBFPCUK Chrome

Ex.VAT **£148.88** Inc.VAT **£178.66**

**Satinjet®
KEA BATH SHOWER MIXER**



INLET CONNECTIONS:
3/4" BSP
WORKING PRESSURE:
0.5 – 5.0 bar

- Includes Maku Satinjet handset, 1.5m hose & wall bracket
- Supplied with 9l/min flow regulator



KEBSMCPUK Chrome

Ex.VAT **£176.97** Inc.VAT **£212.36**

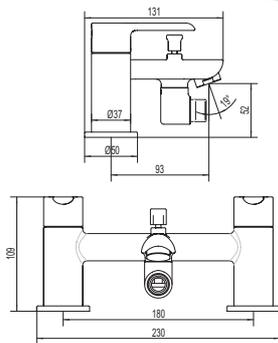

Curved bodies and crisp edges combine to create the Breeze tapware range. Featuring the latest innovation in tapware design and contemporary styling.

BREEZE BASIN MIXER

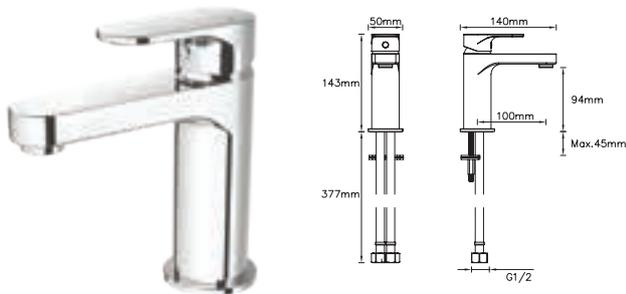

INLET CONNECTIONS:
1/2" BSP

WORKING PRESSURE:
0.5 – 5.0 bar

- Ceramic Cartridge
- Includes clicker waste
- Twin stud clamp kit



water label L/Min 15.5

BRBCPUK Chrome

Ex.VAT £120.79 Inc.VAT £144.95

BREEZE BATH FILLER

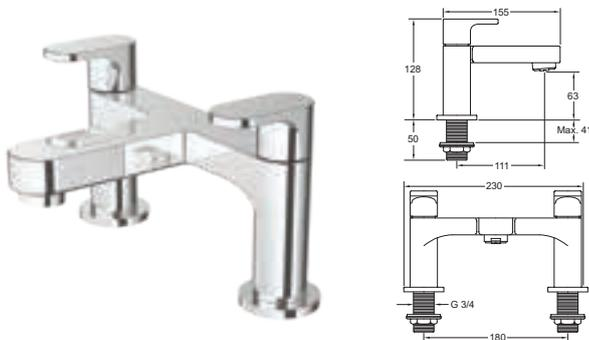

INLET CONNECTIONS:
3/4" BSP

WORKING PRESSURE:
0.3 – 5.0 bar



BRBFPUK Chrome

Ex.VAT £176.97 Inc.VAT £212.36

Satinjet®

BREEZE BATH SHOWER MIXER



INLET CONNECTIONS:
3/4" BSP

WORKING PRESSURE:
0.5 – 5.0 bar

- Includes Maku Satinjet handset, 1.5m hose & wall bracket



BRBSMCPUK Chrome

Ex.VAT £205.06 Inc.VAT £246.07

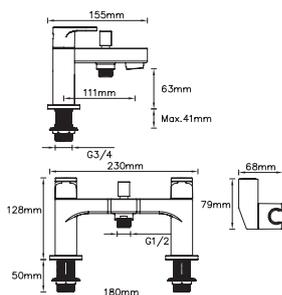

Beautifully designed to reflect the latest in luxury modern trends, the Indra tap range will glorify any space. Flowing curved spouts combined with looped, easy to use, handles delivers a style which not only looks amazing but is intuitive to use.



INDRA BASIN MIXER

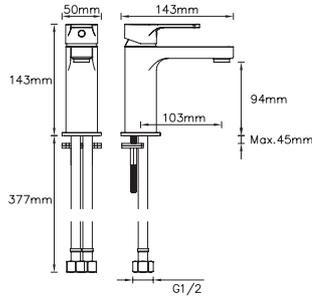

INLET CONNECTIONS:
3/2" BSP
WORKING PRESSURE:
0.5 – 5.0 bar

- Ceramic Cartridge
- Includes clicker waste
- Twin stud clamp kit



water label L/Min **15.5**

INBCPUK Chrome

Ex.VAT **£120.79** Inc.VAT **£144.95**

INDRA BATH FILLER

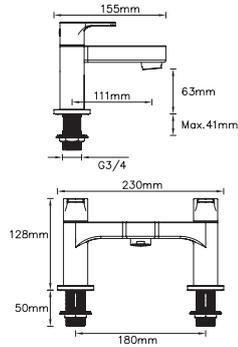

INLET CONNECTIONS:
3/4" BSP
WORKING PRESSURE:
0.3 – 5.0 bar



INBFCPUK Chrome

Ex.VAT **£176.97** Inc.VAT **£212.36**

Satinjet®

INDRA BATH SHOWER MIXER



INLET CONNECTIONS:
3/4" BSP
WORKING PRESSURE:
0.5 – 5.0 bar

- Includes Maku Satinjet handset, 1.5m hose & wall bracket



INBSMCPUK Chrome

Ex.VAT **£205.06** Inc.VAT **£246.07**

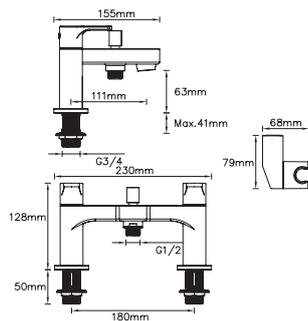

Curved bodies and crisp edges combine to create the Cari tapware range. Featuring the latest in tapware design and contemporary styling, this range closes the gap between luxury and affordability.

CARI BASIN MIXER

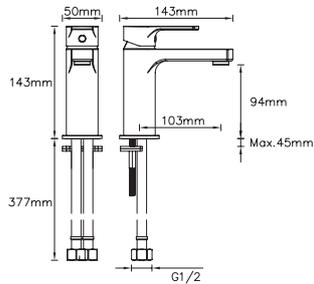

INLET CONNECTIONS:
1/2" BSP

WORKING PRESSURE:
0.5 - 5.0 bar

- Ceramic Cartridge
- Includes clicker waste
- Twin stud clamp kit



water label L/Min 15.5

CABCPUK Chrome

Ex.VAT £120.79 Inc.VAT £144.95

CARI BATH FILLER

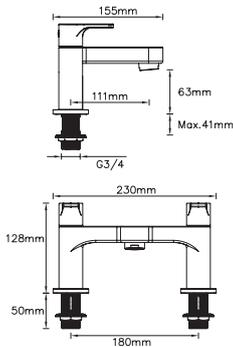

INLET CONNECTIONS:
3/4" BSP

WORKING PRESSURE:
0.3 - 5.0 bar



CABFCPUK Chrome

Ex.VAT £176.97 Inc.VAT £212.36

Satinjet®

CARI BATH SHOWER MIXER

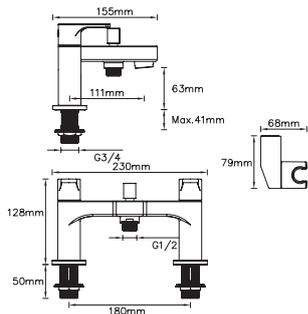

INLET CONNECTIONS:
3/4" BSP

WORKING PRESSURE:
0.5 - 5.0 bar

- Includes Maku Satinjet handset, 1.5m easy clean hose & wall bracket



CABSMCPUK Chrome

Ex.VAT £205.06 Inc.VAT £246.07

ROUND CLICKER WASTE

• Simply push to open & close

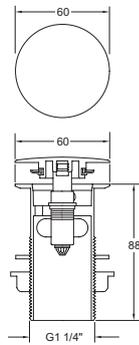

WST304 Chrome

Ex.VAT **£37.45** Inc.VAT **£44.94**

SQUARE CLICKER WASTE

• Simply push to open & close

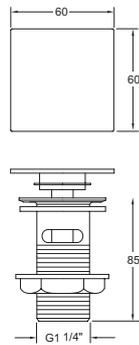

WST318 Chrome

Ex.VAT **£42.14** Inc.VAT **£50.57**

FREE FLOW WASTE

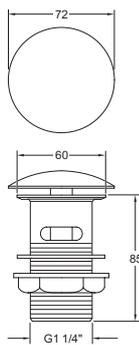

WST307 Chrome

Ex.VAT **£37.45** Inc.VAT **£44.94**

OVERFLOW BATH FILLER WITH CLICKER OR POP UP WASTE

• Ideal for use with Methven 3 Dial Valves

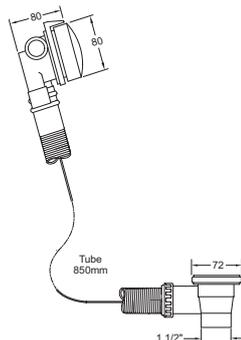

OBFC Chrome Clicker

Ex.VAT **£163.85** Inc.VAT **£196.62**

OBFP Chrome Pop-up

Ex.VAT **£154.50** Inc.VAT **£185.40**



THE SHOWER & TAP BRAND.

Deva showers and bathroom and kitchen taps provide a wide variety of products for both domestic and commercial applications.

As one of the largest suppliers of showers and taps to the UK market and with over 25 years heritage, Deva has developed a reputation for providing excellent levels of service and customer care, bringing products to the market of the highest quality at the right price. From concept through to manufacture, we are backed by a testing programme unrivalled in our industry.

Deva deliver the latest styles of bathroom and kitchen taps, showers and shower accessories, next day – nationwide. We pride ourselves on our service first policy. Not only do we deliver 98% of orders next day in full, we also aim to provide the highest standards of customer service. Our in-house customer service technicians are fully trained to provide personal, friendly and in-depth support as well as our field based Area Sales Managers.

Deva became part of the Methven Group in 2007 and operates from Methven UK headquarters in Lancashire. Methven as a group, are innovative, design focussed and conscious to produce product ranges which meet both consumer need, legislation and regulatory requirements whilst being environmentally minded.

HAVE CONFIDENCE IN US

DEVA BY METHVEN BRAND WARRANTY (SUBJECT TO THE TERMS AND CONDITIONS)		
PRODUCT	PARTS	LABOUR
CHROME TAPWARE**	12 YEARS	2 YEARS
SHOWER VALVES	5 YEARS	2 YEARS
SHOWER ACCESSORIES	1 YEAR	
ELECTRICAL PRODUCTS (INCLUDING SENSOR TAPS)	2 YEARS	2 YEARS

* For the lifetime of the original purchaser

** All other finishes 5 Years Parts, 2 Years Labour

Any product that has not been fitted in a private dwelling located in the United Kingdom or the Republic of Ireland will be subject to our Commercial Warranty of 12 months parts and labour, as set out in Condition 8 of Methven's Terms and Conditions of Sale. Excludes sensor and thermostatic products. For full terms and conditions see www.methven.com

DEVA SHOWERS

THERMOSTATIC BAR SHOWERS

COMBI BAR SHOWER WITH MULTI MODE KIT

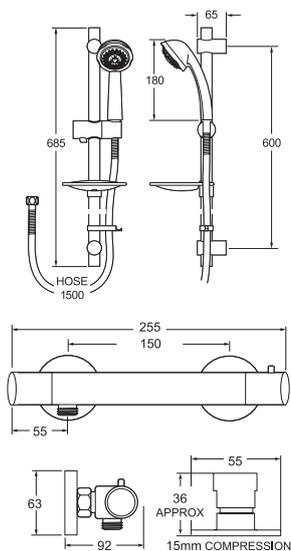

VALVE:

Thermostatic

OPERATION:

Separate flow and temperature controls

INLET CONNECTIONS:

15mm Compression

WORKING PRESSURE:

0.5 – 5.0 bar

- 38°C temperature hot stop with override facility
- Includes easy fit connections
- Double interlocked 1.5m hose
- Riser rail features adjustable brackets – ideal for retrofit
- TMV2 approved valve



COMBMEF Chrome

Ex.VAT £168.12 Inc.VAT £201.74

VISION BAR SHOWER WITH MULTI MODE KIT

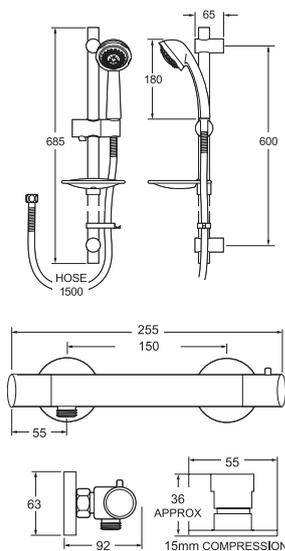

VALVE:

Thermostatic

OPERATION:

Separate flow and temperature controls

INLET CONNECTIONS:

15mm Compression

WORKING PRESSURE:

0.5 – 5.0 bar

- 38°C temperature hot stop with override facility
- Includes easy fit connections
- Double interlocked 1.5m hose
- Riser rail features adjustable brackets – ideal for retrofit
- TMV2 approved valve



VSNBMEF Chrome

Ex.VAT £174.02 Inc.VAT £208.82

RESPONSE BAR SHOWER WITH MULTI MODE KIT

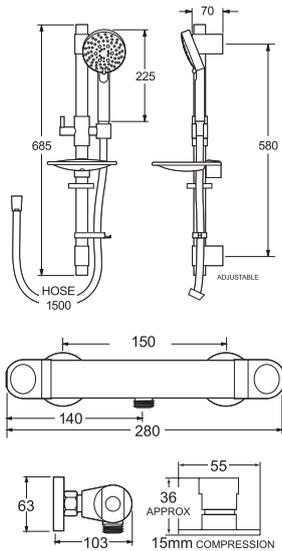

VALVE:

Thermostatic

OPERATION:

Separate flow and temperature controls

INLET CONNECTIONS:

15mm Compression

WORKING PRESSURE:

0.3 – 5.0 bar

- 38°C temperature hot stop
- Riser rail features adjustable brackets – ideal for retrofit
- Smooth easy clean 1.5m hose



RESBMEF Chrome

Ex.VAT £205.28 Inc.VAT £246.34

VISION BAR SHOWER WITH MULTI MODE KIT

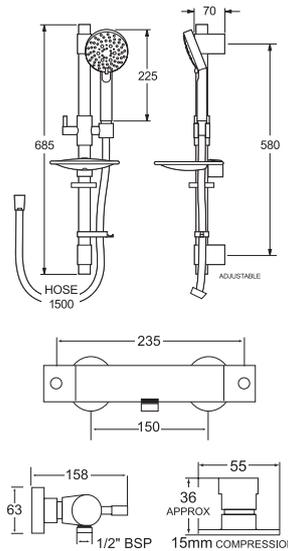

VALVE:

Thermostatic

OPERATION:

Separate flow and temperature controls

INLET CONNECTIONS:

15mm Compression

WORKING PRESSURE:

0.3 – 5.0 bar

- 38°C temperature hot stop
- Riser rail features adjustable brackets – ideal for retrofit
- Smooth easy clean 1.5m hose



VSN2BMEF Chrome

Ex.VAT £223.56 Inc.VAT £268.27

DEVA SHOWERS

THERMOSTATIC BAR SHOWERS

SAVVI BAR SHOWER WITH SINGLE MODE KIT

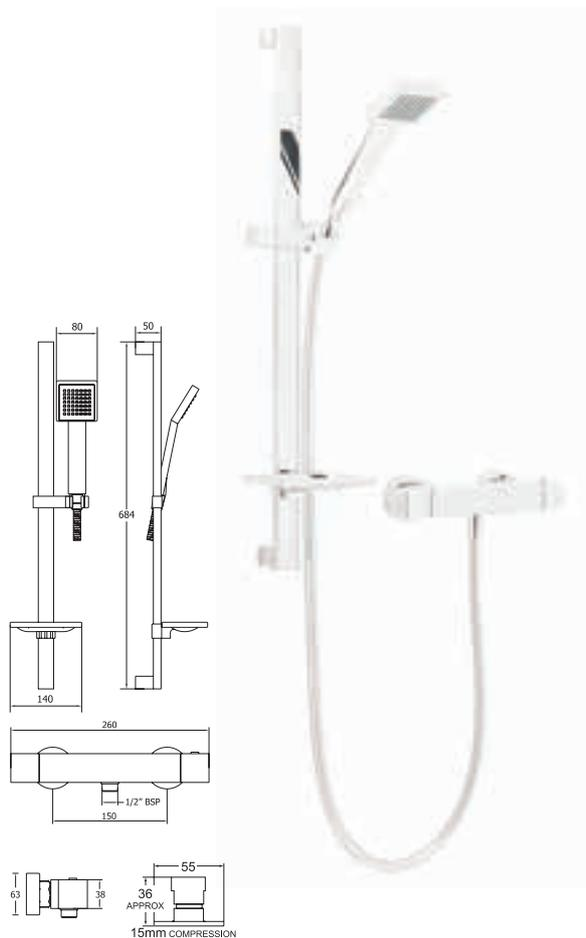

VALVE:

Thermostatic

OPERATION:

Separate flow and temperature controls

INLET CONNECTIONS:

15mm Compression

WORKING PRESSURE:

0.3 – 5.0 bar

- 38°C temperature hot stop with override facility
- Smooth easy clean 1.5m hose



SAVBSEF Chrome

Ex.VAT £261.32 Inc.VAT £313.58

KESTREL COOL TO TOUCH BAR SHOWER WITH SINGLE MODE KIT

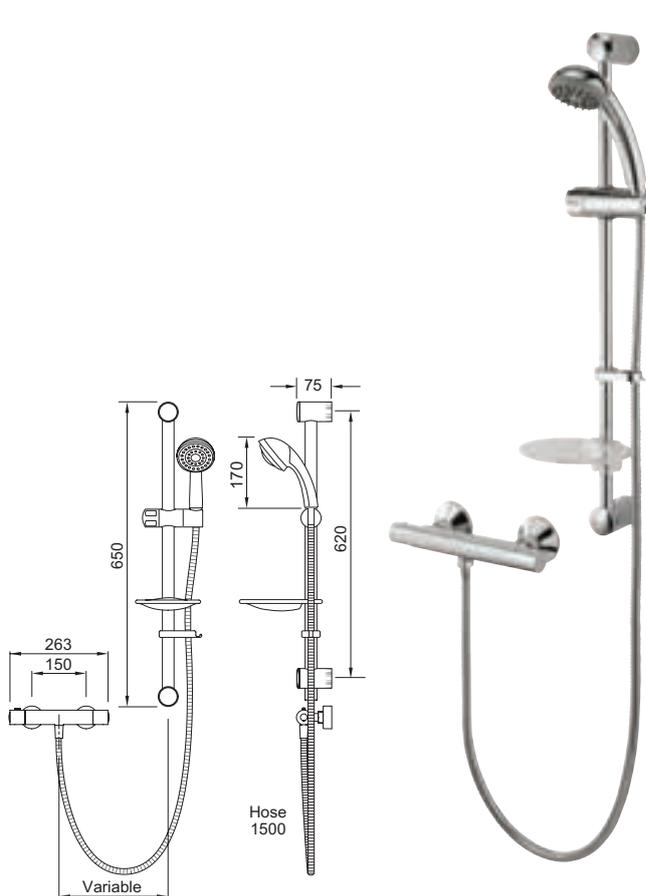

VALVE:

Thermostatic

OPERATION:

Separate flow and temperature controls

INLET CONNECTIONS:

1/2" BSP

WORKING PRESSURE:

0.5 – 5.0 bar

- Safe cool to touch body
- 38°C temperature hot stop with override facility
- Double interlocked 1.5m hose



KESCTS Chrome

Ex.VAT £92.70 Inc.VAT £111.24

COMBI BAR SHOWER WITH SINGLE MODE KIT

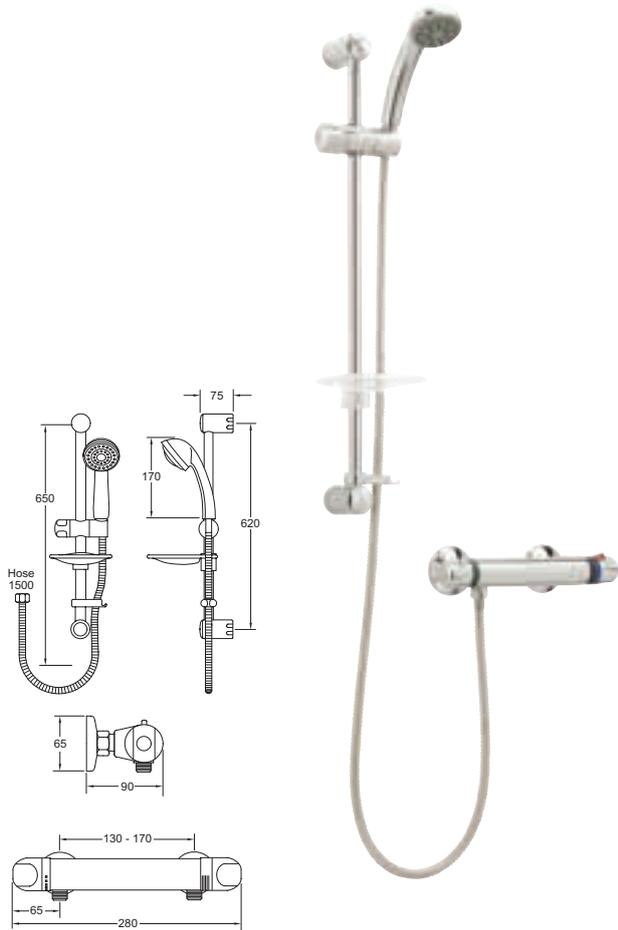

VALVE:

Thermostatic

OPERATION:

Separate flow and temperature controls

INLET CONNECTIONS:

1/2" BSP

WORKING PRESSURE:

0.5 – 5.0 bar

- 38°C temperature hot stop with override facility



COMBS Chrome

Ex.VAT £111.43 Inc.VAT £133.72

DYNAMIC COOL TO TOUCH BAR SHOWER WITH DIVERTER TO FIXED HEAD & HANDSET

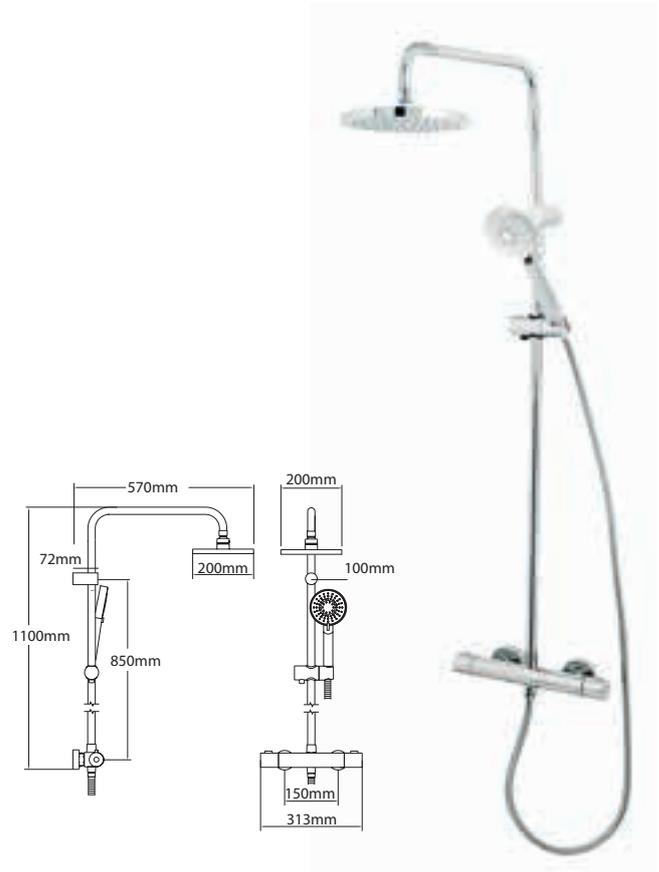

VALVE:

Thermostatic

OPERATION:

Separate flow and temperature controls

INLET CONNECTIONS:

15mm Compression

WORKING PRESSURE:

1.5 – 5.0 bar

- Safe cool to touch body
- 38°C temperature hot stop with override facility
- Integral diverter to fixed head and handset
- Double interlocked 1.5m hose



DCTSDEF Chrome

Ex.VAT £326.78 Inc.VAT £392.14

DEVA SHOWERS

THERMOSTATIC BAR SHOWERS

VISION BAR SHOWER WITH DIVERTER TO FIXED HEAD & HANDSET

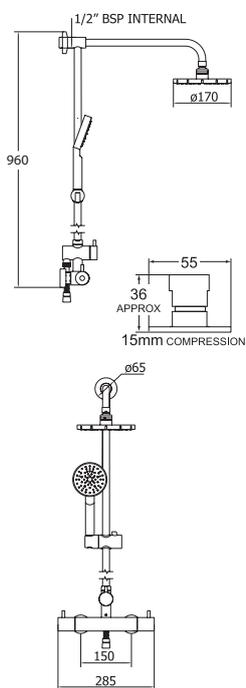

VALVE:

Thermostatic

OPERATION:

Separate flow and temperature controls

INLET CONNECTIONS:

15mm Compression

WORKING PRESSURE:

1.0 – 5.0 bar

- 38°C temperature hot stop with override facility
- Diverter to fixed head and handset
- Double interlocked 1.5m hose



water label L/Min 16.7

VSNBDEF Chrome

Ex.VAT £372.81 Inc.VAT £447.37

SAVI COOL TO TOUCH BAR SHOWER WITH DIVERTER TO FIXED HEAD & HANDSET



VALVE:

Thermostatic

OPERATION:

Separate flow and temperature controls

INLET CONNECTIONS:

15mm Compression

WORKING PRESSURE:

1.5 – 5.0 bar

- Safe cool to touch body
- 38°C temperature hot stop with override facility
- Integral diverter to fixed head and handset
- Double interlocked 1.5m hose



SCTSDEF Chrome

Ex.VAT £362.17 Inc.VAT £434.60

VERTICAL L SHAPED BAR SHOWER VALVE

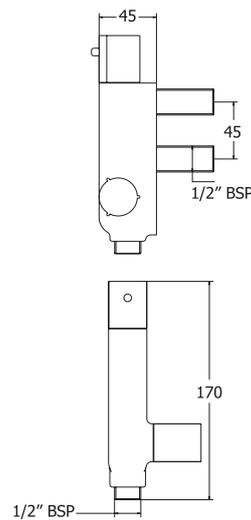

VALVE:

Thermostatic

OPERATION:

Separate flow and temperature controls

INLET CONNECTIONS:

1/2" BSP

WORKING PRESSURE:

1.0 – 5.0 bar

- 38°C temperature hot stop with override facility



VVERT01 Chrome

Ex.VAT £107.36 Inc.VAT £128.83

DEVA SHOWERS

CONCENTRIC SHOWERS

VISION CONCENTRIC SHOWER WITH MULTI MODE KIT

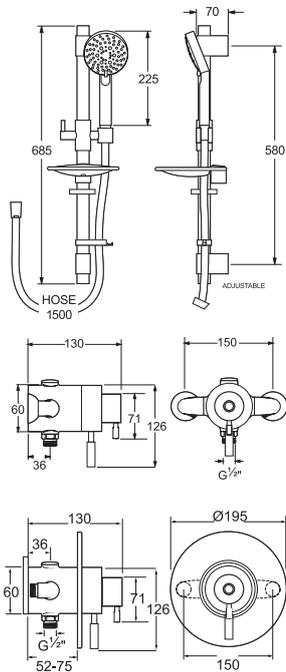

VALVE:
Thermostatic
OPERATION:
Separate flow and temperature controls
INLET CONNECTIONS:
15mm Compression
WORKING PRESSURE:
0.1 – 5.0 bar

- Exposed and concealed valve options in one box
- Includes wall union for concealed installations
- Smooth easy clean 1.5m hose
- Riser rail features adjustable brackets – ideal for retrofit
- TMV2 approved valve



VSNCONT03 Chrome

Ex.VAT £434.75 Inc.VAT £521.70

VISION CONCENTRIC SHOWER VALVE

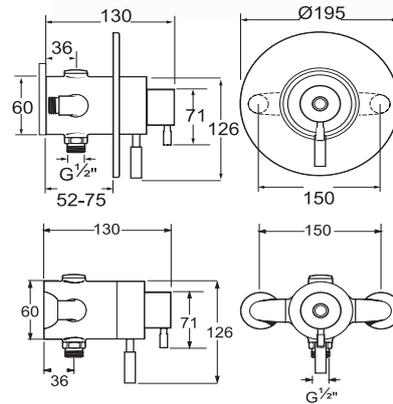

VALVE:
Thermostatic
OPERATION:
Separate flow and temperature controls
INLET CONNECTIONS:
15mm Compression
WORKING PRESSURE:
0.1 – 5.0 bar

- Exposed and concealed valve options in one box
- Includes wall union for concealed installations
- TMV2 approved valve



VSNVCONT04 Chrome

Ex.VAT £353.93 Inc.VAT £424.72



WATER SAVING SHOWER FLOW REGULATORS



Deva offers a range of Enviro-wise[™] products that are suitable for application where Part G applies.

Sold in singles

Code	Description	Ex.VAT	Inc.VAT
HSR 2	Seal Flow Regulator - 2 L/min Replaces standard seal	£2.95	£3.54
HSR 3	Seal Flow Regulator - 3 L/min Replaces standard seal	£2.95	£3.54
HSR 4	Seal Flow Regulator - 4 L/min Replaces standard seal	£2.95	£3.54
HSR 6	Seal Flow Regulator - 6 L/min Replaces standard seal	£2.95	£3.54
HSR 8	Seal Flow Regulator - 8 L/min Replaces standard seal	£2.95	£3.54
HSR 9	Seal Flow Regulator - 9 L/min Replaces standard seal	£2.95	£3.54
FR106-12	Flow Regulator - 12 L/min For showers above 1 bar	£7.66	£9.19
FR106-7	Flow Regulator - 7 L/min For showers above 1 bar	£7.66	£9.19
FRAV 9	Flow Regulator (for AVSH001)	£2.95	£3.54

DEVA SHOWERS

CONCENTRIC SHOWERS

GEORGIAN CONCENTRIC SHOWER WITH SINGLE MODE KIT



VALVE:

Thermostatic

OPERATION:

Separate flow and temperature controls

INLET CONNECTIONS:

15mm Compression

WORKING PRESSURE:

0.1 – 5.0 bar

- Exposed and concealed valve options in one box
- Includes wall union for concealed installations
- Double interlocked 1.5m hose
- TMV2 approved valve

GEORGIAN TRADITIONAL EXPOSED CONCENTRIC SHOWER WITH RIGID RISER & ROSE

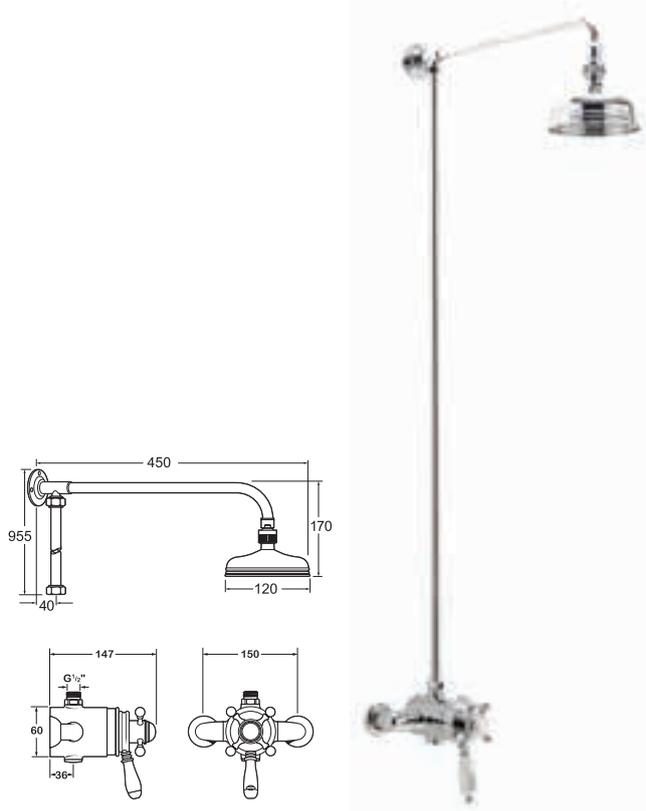

VALVE:

Thermostatic

OPERATION:

Separate flow and temperature controls

INLET CONNECTIONS:

15mm Compression

WORKING PRESSURE:

0.1 – 5.0 bar

- Rigid riser and traditional rose with swivel joint
- TMV2 approved valve



GEOCONT05 Chrome

Ex.VAT £471.91 Inc.VAT £566.29



GEOCR R Chrome

Ex.VAT £506.71 Inc.VAT £608.05





Get The *Georgian Look*...



A/B. Georgian Traditional Exposed Valve with Rigid Riser and Rose.
Code: GEOCRR. See page 72

C. Georgian Basin Taps.
Code: GEO1. See page 114

D. Georgian Pillar Mounted Bath Shower Mixer.
Code: GEO3. See page 115

GET THE WHOLE
**GEORGIAN
LOOK**
FOR ONLY

£1008.71 ex. VAT

£1210.45 inc. VAT

DEVA SHOWERS

SEQUENTIAL & DUAL CONTROL SHOWERS

VISION EXPOSED SEQUENTIAL SHOWER VALVE

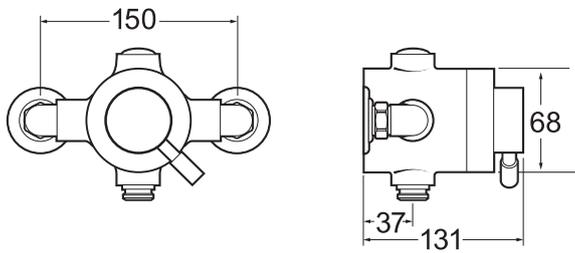

VALVE:
Thermostatic
OPERATION:
Single control for flow and temperature
INLET CONNECTIONS:
15mm Compression
WORKING PRESSURE:
0.1 – 5.0 bar



VSNVSEQT01 Chrome Ex.VAT £324.44 Inc.VAT £389.33

VISION CONCEALED SEQUENTIAL SHOWER VALVE

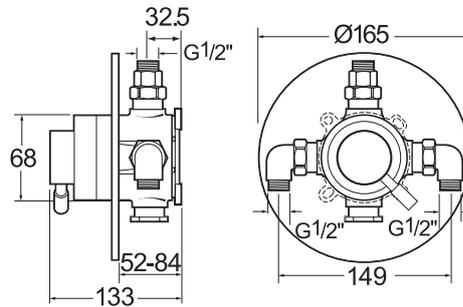

VALVE:
Thermostatic
OPERATION:
Single control for flow and temperature
INLET CONNECTIONS:
15mm Compression
WORKING PRESSURE:
0.1 – 5.0 bar



VSNVSEQT02 Chrome Ex.VAT £324.44 Inc.VAT £389.33

SOL SEQUENTIAL VALVE

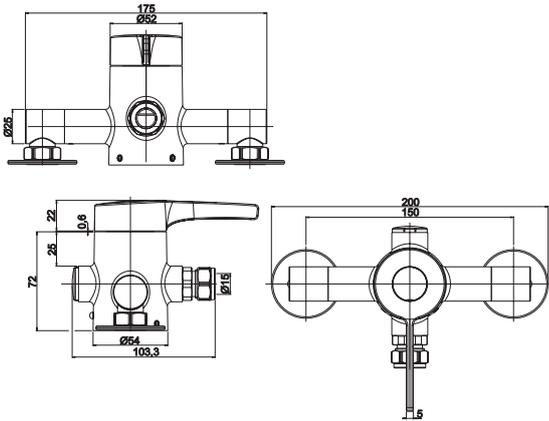

VALVE:

Thermostatic

OPERATION:

Single control for flow and temperature

INLET CONNECTIONS:

15mm Compression

WORKING PRESSURE:

0.2 – 5.0 bar

- Longer lever for ease of use
- Twin with PHK1 kit, see page 47



SSV Chrome

Ex.VAT £186.33 Inc.VAT £223.60

CONTEMPORARY DUAL CONTROL SHOWER VALVE

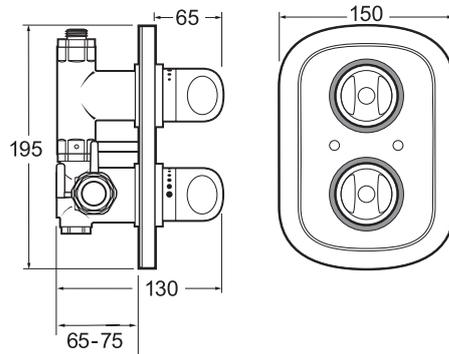

VALVE:

Thermostatic

OPERATION:

Separate flow and temperature controls

INLET CONNECTIONS:

15mm Compression

WORKING PRESSURE:

0.3 – 5.0 bar

- Chrome plated metal concealing plate



water label L/Min 16.7

ROUVDUAT01 Chrome

Ex.VAT £223.56 Inc.VAT £268.27

DEVA SHOWERS

MANUAL SHOWERS

ADORE MANUAL SHOWER VALVE WITH SINGLE MODE KIT



VALVE:
Manual

OPERATION:
Single lever flow and temperature control

INLET CONNECTIONS:
15mm Compression

WORKING PRESSURE:
0.1 – 5.0 bar

- Ceramic cartridge
- Exposed and concealed valve options in one box
- Double interlocked 1.5m hose
- Includes wall union for concealed installations

LACE MANUAL SHOWER VALVE WITH SINGLE MODE KIT



VALVE:
Manual

OPERATION:
Single lever flow and temperature control

INLET CONNECTIONS:
15mm Compression

WORKING PRESSURE:
0.1 – 5.0 bar

- Ceramic cartridge
- Exposed and concealed valve options in one box
- Double interlocked 1.5m hose
- Includes wall union for concealed installations



ADOCMANM01 Chrome

Ex.VAT £161.61 Inc.VAT £193.93



LACCMANM02 Chrome

water label L/Min 8.1

Ex.VAT £161.61 Inc.VAT £193.93



LACE MANUAL SHOWER VALVE

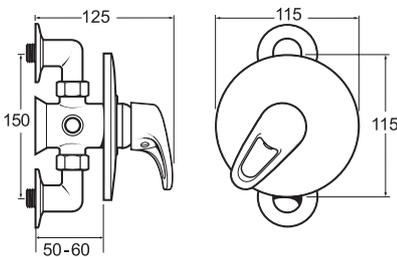

VALVE:
Manual

OPERATION:
Single lever flow and temperature control

INLET CONNECTIONS:
15mm Compression

WORKING PRESSURE:
0.1 – 5.0 bar

- Ceramic cartridge
- Exposed and concealed valve options in one box



LACVMANM03 Chrome

Ex.VAT £116.31 Inc.VAT £139.57

LACVMANM03/G Gold

Ex.VAT £140.79 Inc.VAT £168.95

SAVI COOL TO TOUCH BAR SHOWER WITH DIVERTER TO FIXED HEAD & HANDSET



See page 69



- Safe cool to touch body
- 38°C temperature hot stop with override facility
- Integral diverter to fixed head and handset
- Double interlocked 1.5m hose

DEVA SHOWERS

SHOWER KITS

CORE SINGLE MODE SIGNATURE SHOWER KIT

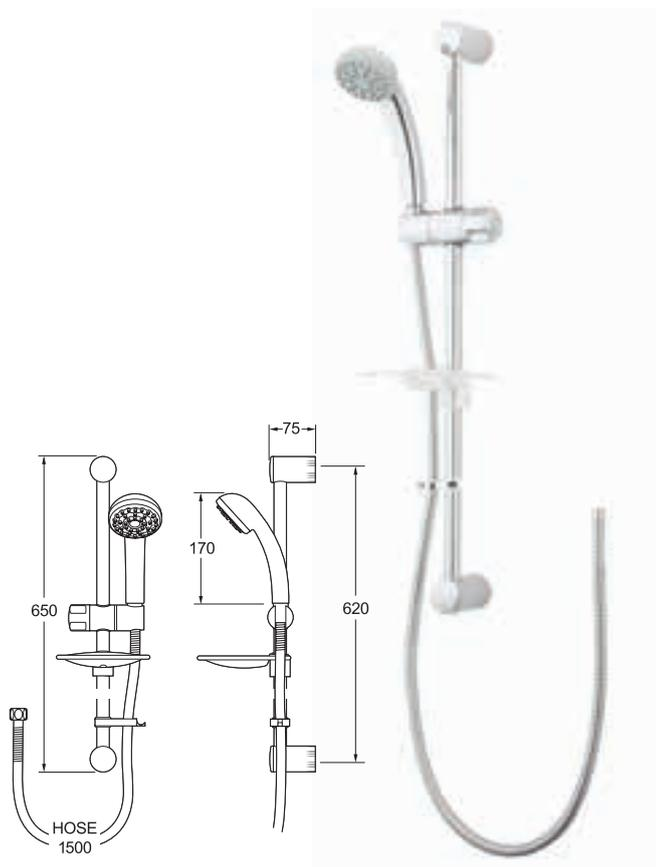

WORKING PRESSURE:
0.1 – 5.0 bar



SIGKITS01 Chrome

Ex.VAT **£37.76** Inc.VAT **£45.31**

5 MODE SHOWER KIT

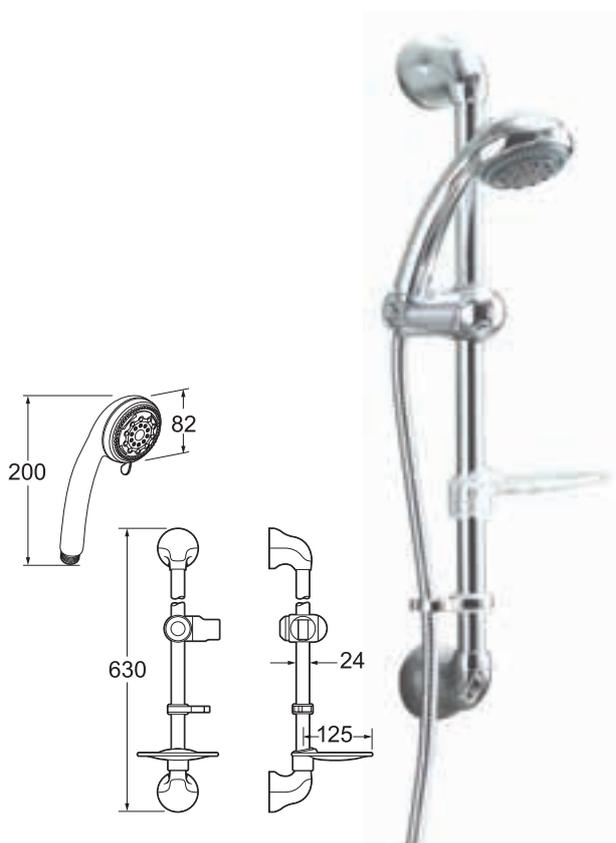

WORKING PRESSURE:
0.5 – 5.0 bar

- Double interlocked 1.5 metre hose



KITM03 Chrome

Ex.VAT **£56.04** Inc.VAT **£67.25**

SQUARE SHOWER KIT

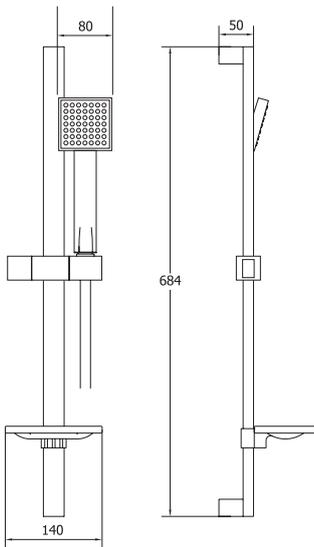

WORKING PRESSURE:
0.1 – 5.0 bar

- Smooth easy clean 1.5 metre hose



KITS02 Chrome

Ex.VAT **£74.92** Inc.VAT **£89.90**

PERIOD STYLE SHOWER KIT

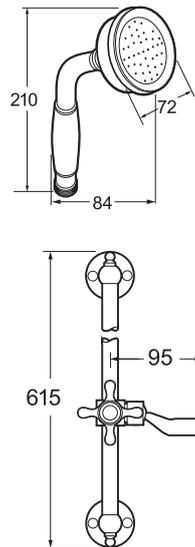

WORKING PRESSURE:
0.1 – 5.0 bar

- Double interlocked 1.5 metre hose



KITS06 Chrome

Ex.VAT **£124.47** Inc.VAT **£149.36**

KITS06/G Gold

Ex.VAT **£153.66** Inc.VAT **£184.39**

DEVA SHOWERS

SHOWER KITS

SUBSTANCE 3 MODE SIGNATURE KIT

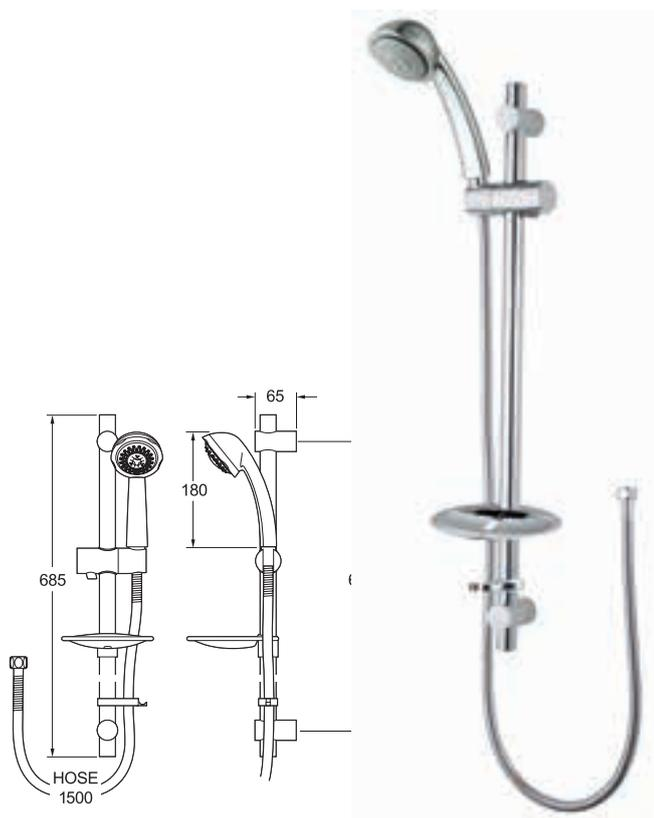

WORKING PRESSURE:
0.3 – 5.0 bar

- Double interlocked 1.5 metre hose
- Riser rail features adjustable brackets – ideal for retrofit

KROME & KROME WITH AIR 3 MODE SHOWER KIT

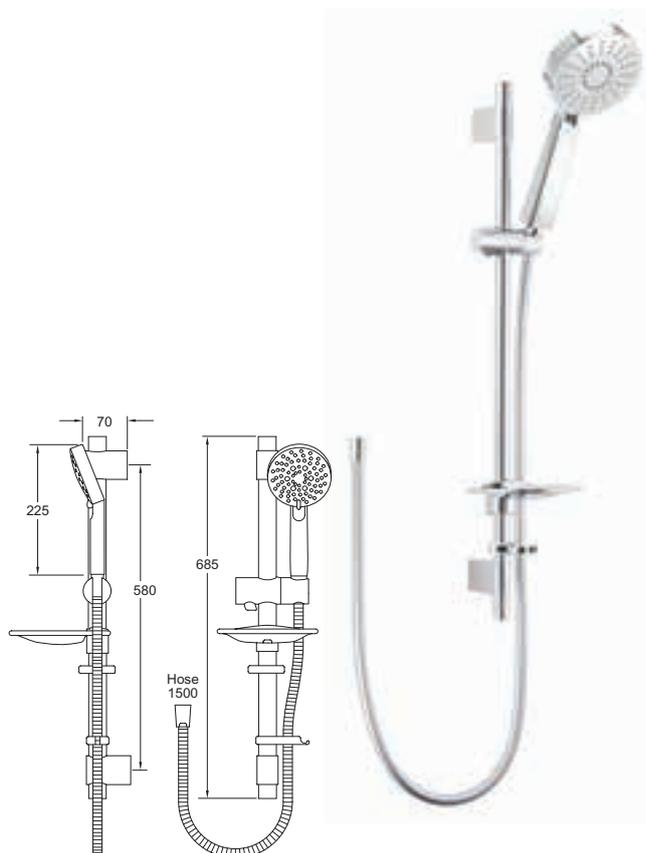

WORKING PRESSURE:
0.1 – 5.0 bar

- Riser rail features adjustable brackets – ideal for retrofit
- Also available as air injection model – use /A code



SIGKITM02 Chrome

Ex.VAT **£62.53** Inc.VAT **£75.04**



KMKIT Chrome

Ex.VAT **£83.56** Inc.VAT **£100.27**

KMKIT/A Chrome

Ex.VAT **£86.52** Inc.VAT **£103.82**

PERIOD STYLE RIGID RISER SHOWER KIT



WORKING PRESSURE:
0.1 – 5.0 bar

- Swivel joint



KITS08 Chrome Ex.VAT £155.74 Inc.VAT £186.89

KITS08/G Gold Ex.VAT £186.10 Inc.VAT £223.32

MINIMALIST RIGID RISER KIT WITH DIVERTER TO FIXED HEAD AND HANDSET

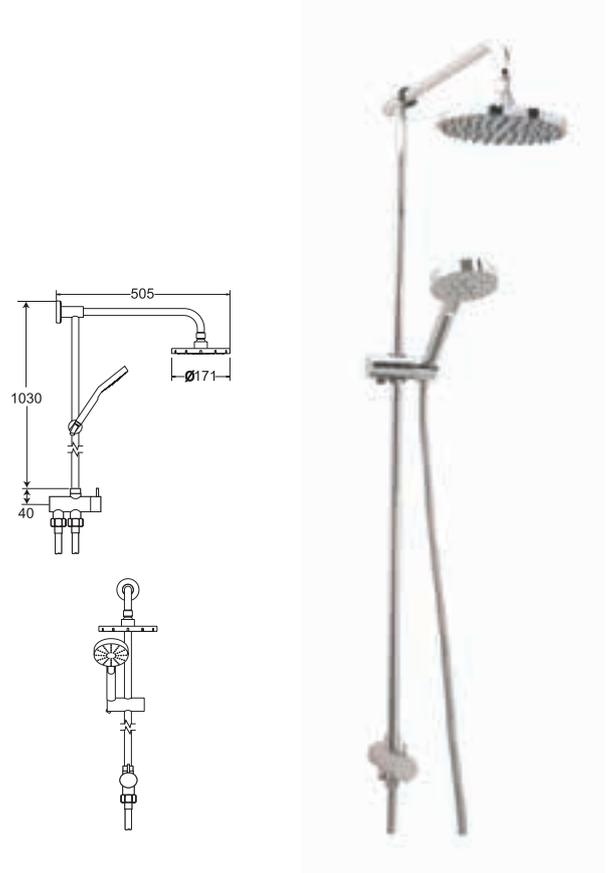

WORKING PRESSURE:
1.0 – 5.0 bar

- Fixed head with swivel joint
- Rub clean nozzles



KITS09 Chrome Ex.VAT £223.56 Inc.VAT £268.27

DEVA SHOWERS

ARMS & HEADS

2" (50MM) BRASS SHOWER HEAD WITH SWIVEL JOINT

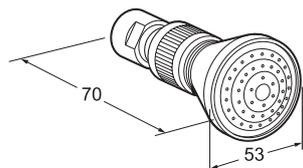

INLET CONNECTIONS:
1/2" BSP
WORKING PRESSURE:
0.1 – 5.0 bar



HEAH01 Chrome

Ex.VAT £19.46 Inc.VAT £23.35

5" (125MM) TRADITIONAL SHOWER HEAD WITH SWIVEL JOINT

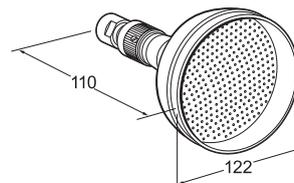

INLET CONNECTIONS:
1/2" BSP
WORKING PRESSURE:
0.1 – 5.0 bar



HEAH02 Chrome

Ex.VAT £49.16 Inc.VAT £58.99

HEAH02/G Gold

Ex.VAT £76.54 Inc.VAT £91.85

8" (220MM) ROUND FIXED HEAD WITH SWIVEL JOINT

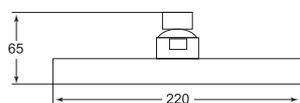

INLET CONNECTIONS:
1/2" BSP
WORKING PRESSURE:
0.1 – 5.0 bar

- Rub clean nozzles



HEAH05 Chrome

Ex.VAT £39.33 Inc.VAT £47.20

KROME 8" (200MM) FIXED HEAD WITH SWIVEL JOINT

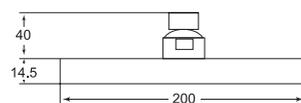

INLET CONNECTIONS:
1/2" BSP
WORKING PRESSURE:
0.1 – 5.0 bar

- Rub clean nozzles



HEAH06 Chrome

Ex.VAT £44.24 Inc.VAT £53.09

8" (200MM) SQUARE SHOWER HEAD WITH SWIVEL JOINT



INLET CONNECTIONS:
1/2" BSP
WORKING PRESSURE:
0.5 – 5.0 bar

- Rub clean nozzles



HEAH04 Chrome

Ex.VAT £54.07 Inc.VAT £64.88

SINGLE MODE SHOWER HEAD WITH ARM



INLET CONNECTIONS:
1/2" BSP
WORKING PRESSURE:
0.1 – 5.0 bar

- Complete with swivel joint
- White Faceplate



HEAA05 Chrome

Ex.VAT £58.30 Inc.VAT £69.96

3 MODE SHOWER HEAD WITH ARM

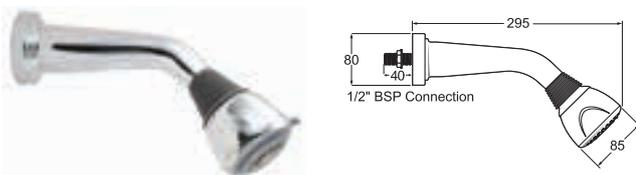

INLET CONNECTIONS:
1/2" BSP
WORKING PRESSURE:
0.5 – 5.0 bar

- Complete with swivel joint



HEAA06 Chrome

Ex.VAT £62.53 Inc.VAT £75.04

ROUND CEILING SHOWER ARM 20CM

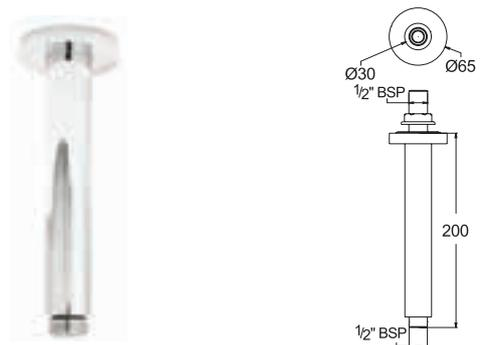

INLET CONNECTIONS:
1/2" BSP

ARMC03 Chrome

Ex.VAT £37.76 Inc.VAT £45.31

DEVA SHOWERS

ARMS & HEADS

SQUARE CEILING SHOWER ARM 20CM

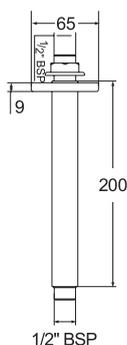

INLET CONNECTIONS:
1/2" BSP

ARMC04 Chrome

Ex.VAT **£43.65** Inc.VAT **£52.38**

SHOWER ARM

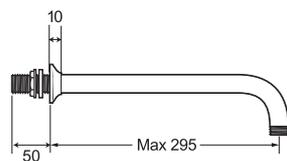

INLET CONNECTIONS:
1/2" BSP

ARMW02 Chrome

Ex.VAT **£26.54** Inc.VAT **£31.85**

BRASS SHOWER ARM

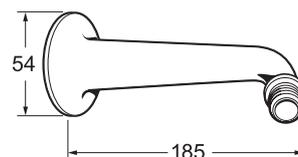

INLET CONNECTIONS:
1/2" BSP

ARMW01 Chrome

Ex.VAT **£23.00** Inc.VAT **£27.60**

ARMW01/G Gold

Ex.VAT **£48.37** Inc.VAT **£58.04**

SQUARE SHOWER ARM

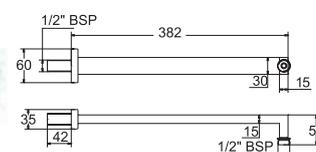

INLET CONNECTIONS:
1/2" BSP

ARMW05 Chrome

Ex.VAT **£50.14** Inc.VAT **£60.17**



WATER SAVING SHOWER FLOW REGULATORS



Deva offers a range of Enviro-wise[™] products that are suitable for application where Part G applies.

Sold in singles

Code	Description	Ex.VAT	Inc.VAT
HSR 2	Seal Flow Regulator - 2 L/min Replaces standard seal	£2.95	£3.54
HSR 3	Seal Flow Regulator - 3 L/min Replaces standard seal	£2.95	£3.54
HSR 4	Seal Flow Regulator - 4 L/min Replaces standard seal	£2.95	£3.54
HSR 6	Seal Flow Regulator - 6 L/min Replaces standard seal	£2.95	£3.54
HSR 8	Seal Flow Regulator - 8 L/min Replaces standard seal	£2.95	£3.54
HSR 9	Seal Flow Regulator - 9 L/min Replaces standard seal	£2.95	£3.54
FR106-12	Flow Regulator - 12 L/min For showers above 1 bar	£7.66	£9.19
FR106-7	Flow Regulator - 7 L/min For showers above 1 bar	£7.66	£9.19
FRAV 9	Flow Regulator (for AVSH001)	£2.95	£3.54

DEVA SHOWERS

HANDSETS, HOSES AND SHOWER ACCESSORIES

VICTORIAN SINGLE MODE HANDSET

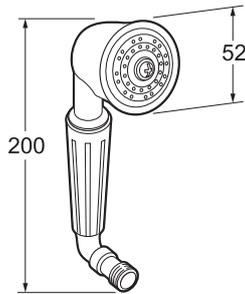

WORKING PRESSURE:
0.1 – 5.0 bar



HANS02 Chrome Ex.VAT £31.26 Inc.VAT £37.51

HANS02/G Gold Ex.VAT £56.94 Inc.VAT £68.33

5 MODE HANDSET

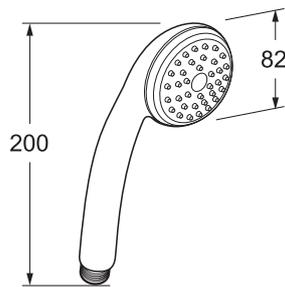

WORKING PRESSURE:
0.5 – 5.0 bar

- Rub clean nozzles



HANM04 Chrome Ex.VAT £25.37 Inc.VAT £30.44

TRADITIONAL SINGLE MODE HANDSET

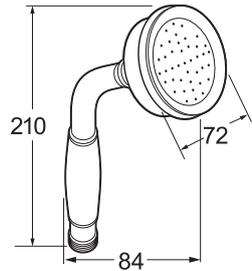

WORKING PRESSURE:
0.1 – 5.0 bar



HANS03 Chrome Ex.VAT £33.62 Inc.VAT £40.34

HANS03/G Gold Ex.VAT £59.39 Inc.VAT £71.27

KROME SINGLE MODE HANDSET 100MM

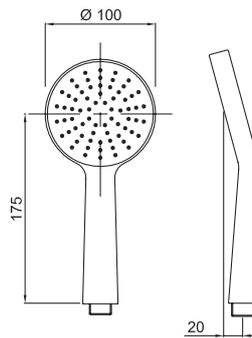

WORKING PRESSURE:
0.1 – 5.0 bar

- Rub clean nozzles
- Chrome face plate



HANS08 Chrome Ex.VAT £19.16 Inc.VAT £22.99

KROME 3 MODE HANDSET 100MM

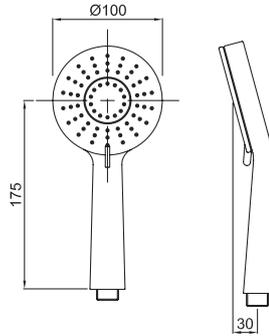

WORKING PRESSURE:
0.3 – 5.0 bar

- Rub clean nozzles
- Chrome face plate



HANM09 Chrome

Ex.VAT £24.57 Inc.VAT £29.48

WALL UNION ROUND

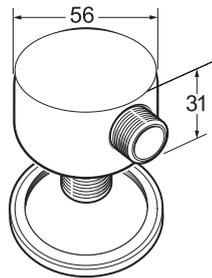

INLET CONNECTIONS:
½" BSP

- Brass construction

SPE01 Chrome

Ex.VAT £19.66 Inc.VAT £23.59

SPE01/G Gold

Ex.VAT £34.65 Inc.VAT £41.58

STANDARD / LARGE BORE CHROME HOSES



INLET CONNECTIONS:
½" BSP
WORKING PRESSURE:
0.1 – 5.0 bar

STANDARD

HOS1.5CPS01 Chrome

Ex.VAT £11.80 Inc.VAT £14.16

HOS1.5CPS01/G Gold

Ex.VAT £35.72 Inc.VAT £42.86

HOS1.75CPS02 Chrome

Ex.VAT £20.06 Inc.VAT £24.07

HOS2.0CPS03 Chrome

Ex.VAT £22.42 Inc.VAT £26.90

LARGE

HOS1.5CPW04 Chrome

Ex.VAT £18.88 Inc.VAT £22.66

HOS1.5CPW04/G Gold

Ex.VAT £40.81 Inc.VAT £48.97

HOS2.0CPW06 Chrome

Ex.VAT £23.60 Inc.VAT £28.32

WALL UNION ROUND

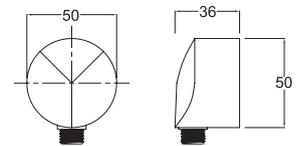

INLET CONNECTIONS:
½" BSP

- Brass construction

SPE03 Chrome

Ex.VAT £21.62 Inc.VAT £25.94

DEVA SHOWERS

SHOWER RAILS & FIXINGS

SHOWER RAIL

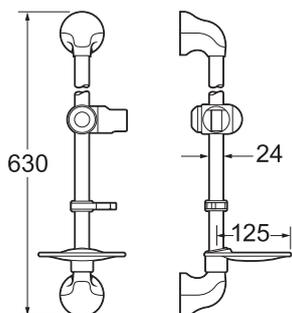

SPE12 Chrome

Ex.VAT **£33.62** Inc.VAT **£40.34**

ADJUSTABLE RISER RAIL

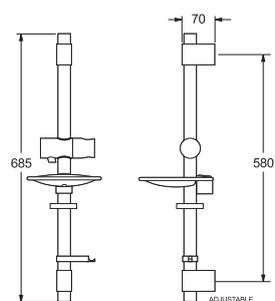

- Riser rail features adjustable brackets – ideal for retrofit

SPE14 Chrome

Ex.VAT **£42.12** Inc.VAT **£50.54**

ADJUSTABLE RISER RAIL

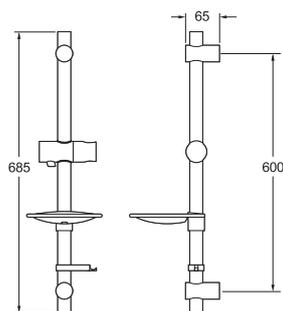

- Riser rail features adjustable brackets – ideal for retrofit

SPE15 Chrome

Ex.VAT **£25.27** Inc.VAT **£30.32**

WALL PLATE FOR BAR SHOWERS

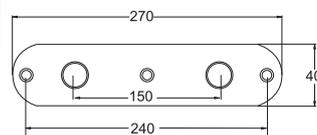
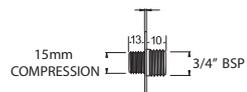

INLET CONNECTIONS:
15mm Compression

- Brass construction
- Wall fixing plate for added stability and ease of installation
- Suitable for most bar shower mixers

SPE10 Chrome

Ex.VAT **£37.76** Inc.VAT **£45.31**

EASY FIX FOR BAR SHOWERS

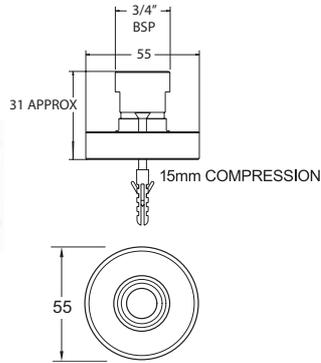

INLET CONNECTIONS:
15mm Compression

- Enables rigid fixing of bar shower
- Sold in pairs
- Trim supplied



SPE11 Chrome

Ex.VAT £31.26 Inc.VAT £37.51

EASY FIX FOR BAR SHOWERS (SQUARE)

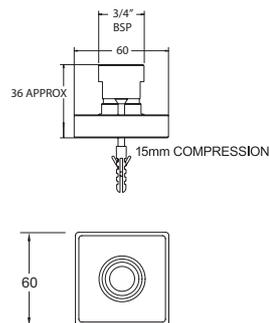

INLET CONNECTIONS:
15mm Compression

- Enables rigid fixing of bar shower
- Sold in pairs
- Trim supplied



SPE11SQ Chrome

Ex.VAT £31.26 Inc.VAT £37.51



EASY FIT MAKES FITTING A BAR VALVE QUICK & REALLY EASY

Most of our thermostatic bar showers now include easy fit connections as standard.



For
**Thermostatic
Bar Showers**
see pages
64-69



STEP 1.
Pipes should extend out from finished tile surface approx 22mm to allow connection.



STEP 2.
Place the brass mounting plate over end of pipe, then mark and drill holes.



STEP 3.
Fit screws and secure plate into position.



STEP 4.
Fit olive over pipe end.



STEP 5.
Fit the threaded union to plate and tighten.



STEP 6.
Fit the trim plate. Fit washer into mixer nut. Connect mixer nut to unions and tighten.

DEVA BATHROOM TAPS

SPARKLE

SPARKLE MONO BASIN MIXER

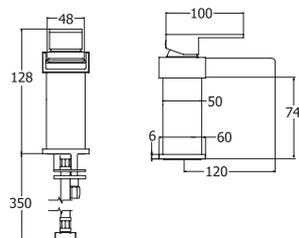

INLET CONNECTIONS:
½" BSP
WORKING PRESSURE:
0.5 – 5.0 bar

- Ceramic cartridge
- Tilt and turn temperature and flow control
- Comes complete with press top waste



SPA113 Chrome

Ex.VAT £186.79 Inc.VAT £224.15

SPARKLE TALL MONO BASIN MIXER

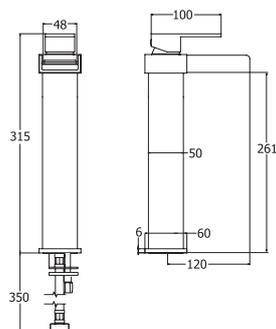

INLET CONNECTIONS:
½" BSP
WORKING PRESSURE:
0.5 – 5.0 bar

- Ceramic cartridge
- Tilt and turn temperature and flow control



SPA113/EX Chrome

Ex.VAT £260.53 Inc.VAT £312.64

SPARKLE MINI MONO BASIN MIXER

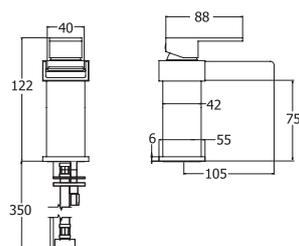

INLET CONNECTIONS:
½" BSP
WORKING PRESSURE:
0.5 – 5.0 bar

- Ceramic cartridge
- Tilt and turn temperature and flow control
- Also available with press top waste – see W code



SPA313 Chrome

Ex.VAT £157.30 Inc.VAT £188.76

SPA313W Chrome

Ex.VAT £170.02 Inc.VAT £204.02

SPARKLE DECK MOUNTED BATH SHOWER MIXER

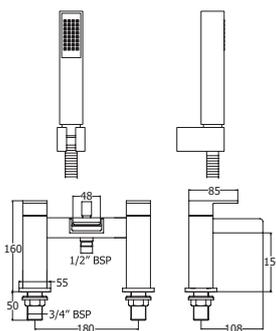

INLET CONNECTIONS:
¾" BSP
WORKING PRESSURE:
0.5 – 5.0 bar

- Comes complete with single mode shower kit and wall bracket



SPA106 Chrome

Ex.VAT £285.12 Inc.VAT £342.14



SPARKLE DECK MOUNTED BATH FILLER

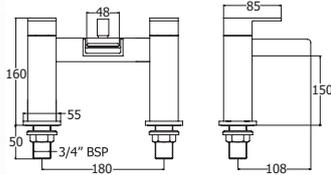

INLET CONNECTIONS:
3/4" BSP
WORKING PRESSURE:
0.5 – 5.0 bar



SPA108 Chrome

Ex.VAT £260.53 Inc.VAT £312.64

SPARKLE MINI MONO BASIN MIXER



**12 YEAR
GUARANTEE**
ON ALL DEVA
CHROME TAPS
*TERMS APPLY



**PRESS TOP WASTES NOW
AVAILABLE WITH MINI MONOS**

Look for the code ending W listed
under Mini Mono.



DEVA BATHROOM TAPS

SAVVI

SAVVI MONO BASIN MIXER

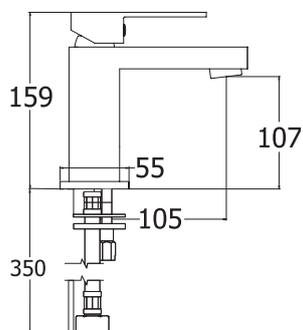

INLET CONNECTIONS:
1/2" BSP
WORKING PRESSURE:
0.5 – 5.0 bar

- Ceramic cartridge
- Tilt and turn temperature and flow control
- Comes complete with press top waste



water label L/Min **10.9**

SAVV113 Chrome

Ex.VAT £142.55 Inc.VAT £171.06

SAVVI TALL MONO BASIN MIXER

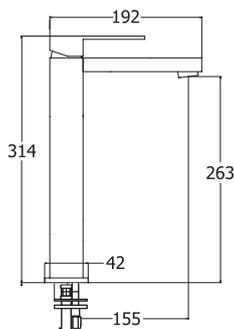

INLET CONNECTIONS:
1/2" BSP
WORKING PRESSURE:
0.5 – 5.0 bar

- Ceramic cartridge
- Tilt and turn temperature and flow control



SAVV113/EX Chrome

Ex.VAT £147.48 Inc.VAT £176.98

SAVVI MINI MONO BASIN MIXER

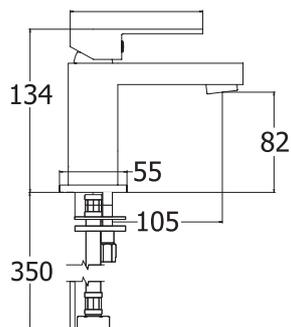

INLET CONNECTIONS:
1/2" BSP
WORKING PRESSURE:
0.5 – 5.0 bar

- Ceramic cartridge
- Tilt and turn temperature and flow control
- Also available with press top waste – see W code



SAVV313 Chrome

Ex.VAT £108.15 Inc.VAT £129.78

SAVV313W Chrome

Ex.VAT £120.87 Inc.VAT £145.04

SAVVI DECK MOUNTED BATH SHOWER MIXER

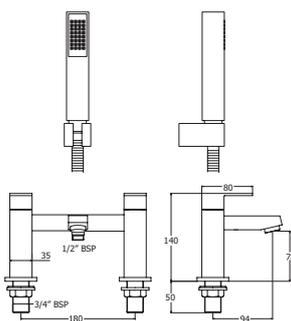

INLET CONNECTIONS:
3/4" BSP
WORKING PRESSURE:
0.5 – 5.0 bar

- Comes complete with single mode shower kit and wall bracket



SAVV106 Chrome

Ex.VAT £226.13 Inc.VAT £271.36

SAVVI DECK MOUNTED BATH FILLER

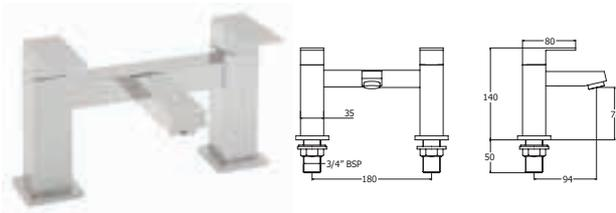

INLET CONNECTIONS:
3/4" BSP

WORKING PRESSURE:
0.5 – 5.0 bar



SAVV108 Chrome

Ex.VAT £176.97 Inc.VAT £212.36



WATER SAVING TAP FLOW REGULATORS



Deva offers a range of Enviro-wise™ products that are suitable for application where Part G applies.

Sold in singles

Code	Description	Ex.VAT	Inc.VAT
FR SP113-1.7	Flow Regulator - For Mono Basin And Sink Mixers – 1.7 L/min	£4.72	£5.66
FR SP113-5	Flow Regulator - For Mono Basin And Sink Mixers – 5 L/min	£4.72	£5.66
FR101-2	Flow Regulator - For Mono Basin And Sink Mixers – 2 L/min	£4.72	£5.66
FR101-3	Flow Regulator - For Mono Basin And Sink Mixers – 3 L/min	£4.72	£5.66
FR101-4	Flow Regulator - For Mono Basin And Sink Mixers – 4 L/min	£4.72	£5.66
FR101-6	Flow Regulator - For Mono Basin And Sink Mixers – 6 L/min	£4.72	£5.66
FR106-4	Outlet Regulator - For Bath Shower Mixers above 1.0 bar	£7.66	£9.19
FR106-7	Flow Regulator - For Bath Shower Mixers above 1.0 bar	£7.66	£9.19
FR106-12	Flow Regulator - For Bath Shower Mixers above 1.0 bar	£7.66	£9.19
FR113-4	Flow Regulator For Mono Basin And Mono Sink Mixers - 4 L/min	£4.72	£5.66
FR113-5	Flow Regulator For Mono Basin And Mono Sink Mixers – 5 L/Min	£4.72	£5.66

DEVA BATHROOM TAPS

SWOOP

SWOOP MONO BASIN MIXER

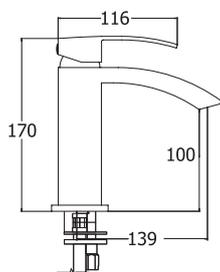

INLET CONNECTIONS:
½" BSP
WORKING PRESSURE:
0.5 – 5.0 bar

- Ceramic cartridge
- Tilt and turn temperature and flow control
- Comes complete with press top waste



SWO113 Chrome

Ex.VAT £142.55 Inc.VAT £171.06

SWOOP TALL MONO BASIN MIXER

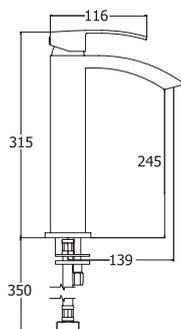

INLET CONNECTIONS:
½" BSP
WORKING PRESSURE:
0.5 – 5.0 bar

- Ceramic cartridge
- Tilt and turn temperature and flow control



SWO113/EX Chrome

Ex.VAT £147.48 Inc.VAT £176.98

SWOOP DECK MOUNTED BATH SHOWER MIXER

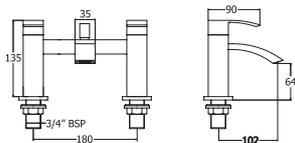

INLET CONNECTIONS:
¾" BSP
WORKING PRESSURE:
0.5 – 5.0 bar

- Comes complete with single mode shower kit and wall bracket



SWO106 Chrome

Ex.VAT £226.13 Inc.VAT £271.36

SWOOP DECK MOUNTED BATH FILLER

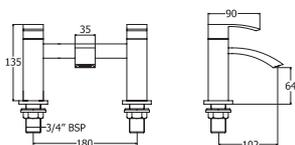

INLET CONNECTIONS:
¾" BSP
WORKING PRESSURE:
0.5 – 5.0 bar



SWO108 Chrome

Ex.VAT £176.97 Inc.VAT £212.36

MAXIMUM STYLE WITH OUR MINI MONOS

AVAILABLE WITH OR WITHOUT WASTES



Mini monos
are approximately
**20%
smaller**
than our standard monos with
no compromise on style or
performance

* Prices shown exclude waste

Vision	VSN313	Ex.VAT	£105.59	Inc.VAT	£126.71
Sparkle	SPA313	Ex.VAT	£157.30	Inc.VAT	£188.76
Insignia	INS313	Ex.VAT	£70.79	Inc.VAT	£84.95
Linx	LINX313	Ex.VAT	£123.88	Inc.VAT	£148.66
Savvi	SAVV313	Ex.VAT	£108.15	Inc.VAT	£129.78
Elan	ELAN313	Ex.VAT	£87.90	Inc.VAT	£105.48
Lace	LACE313	Ex.VAT	£51.43	Inc.VAT	£61.72
Adore	ADORE313	Ex.VAT	£51.43	Inc.VAT	£61.72



DEVA BATHROOM TAPS

VISION

VISION MONO BASIN MIXER

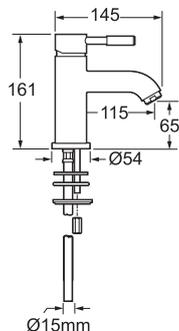

INLET CONNECTIONS:
½" BSP

WORKING PRESSURE:
0.3 – 5.0 bar

- Ceramic cartridge
- Tilt and turn temperature and flow control
- Comes complete with press top waste



VSN113 Chrome

Ex.VAT £155.14 Inc.VAT £186.17

VISION TALL MONO BASIN MIXER

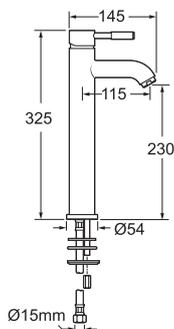

INLET CONNECTIONS:
½" BSP

WORKING PRESSURE:
0.3 – 5.0 bar

- Ceramic cartridge
- Tilt and turn temperature and flow control



VSN113/EX Chrome

Ex.VAT £235.36 Inc.VAT £282.43

VISION MINI MONO BASIN MIXER

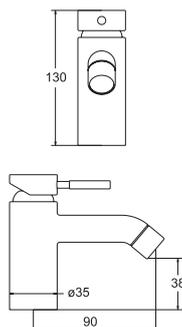

INLET CONNECTIONS:
½" BSP

WORKING PRESSURE:
0.2 – 5.0 bar

- Ceramic cartridge
- Tilt and turn temperature and flow control
- Also available with press top waste – see W code



VSN313 Chrome

Ex.VAT £105.59 Inc.VAT £126.71

VSN313W Chrome

Ex.VAT £118.31 Inc.VAT £141.97

VISION WALL MOUNTED BASIN MIXER

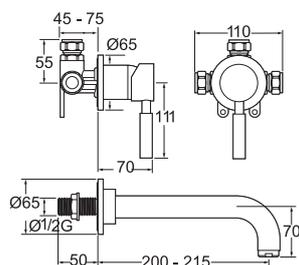

INLET CONNECTIONS:
½" BSP

WORKING PRESSURE:
0.3 – 5.0 bar

- Ceramic cartridge
- Tilt and turn temperature and flow control



VSN122 Chrome

Ex.VAT £179.91 Inc.VAT £215.89

NON CONCUSSIVE VISION SELF CLOSING BASIN TAP

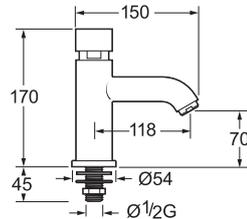

INLET CONNECTIONS:
1/2" BSP
WORKING PRESSURE:
0.3 – 5.0 bar

- Sold as singles
- Pre set automatic shut off after approximately 10 seconds
- Recommended for use with a blending valve see page 149



water label  L/Min **6.8**

VSN123 Chrome

Ex.VAT £111.49 Inc.VAT £133.79

VISION MONO BATH SHOWER MIXER FLOOR MOUNTED

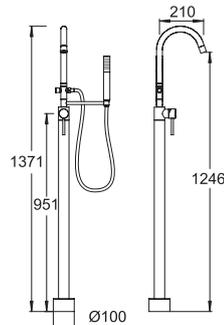

INLET CONNECTIONS:
1/2" BSP
WORKING PRESSURE:
1.0 – 5.0 bar

- Ceramic cartridge
- Tilt and turn temperature and flow control
- Complete mono bath shower mixer with floor mounted stand pipe
- Includes diverter, hose and handset



VSN 1S Chrome

Ex.VAT £309.69 Inc.VAT £371.63

VISION DECK MOUNTED BATH SHOWER MIXER

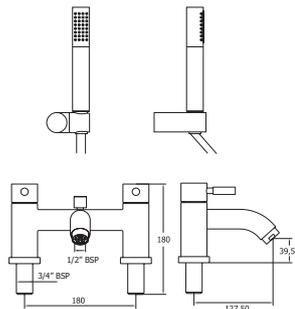

INLET CONNECTIONS:
3/4" BSP
WORKING PRESSURE:
0.5 – 5.0 bar

- Comes complete with single mode shower kit and wall bracket



VSN206 Chrome

Ex.VAT £235.36 Inc.VAT £282.43

VISION DECK MOUNTED BATH FILLER

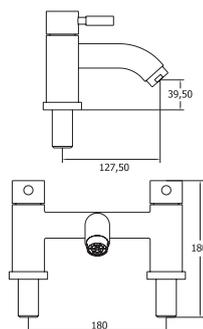

INLET CONNECTIONS:
3/4" BSP
WORKING PRESSURE:
0.3 – 5.0 bar



VSN208 Chrome

Ex.VAT £185.82 Inc.VAT £222.98

DEVA BATHROOM TAPS

LINX

LINX MONO BASIN MIXER

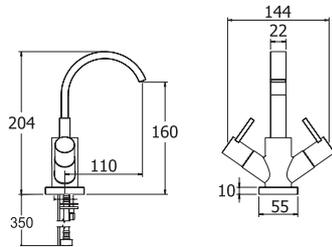

INLET CONNECTIONS:
1/2" BSP
WORKING PRESSURE:
0.2 – 5.0 bar

- Comes complete with press top waste



LINX120 Chrome

Ex.VAT £148.65 Inc.VAT £178.38

LINX MONO BASIN MIXER

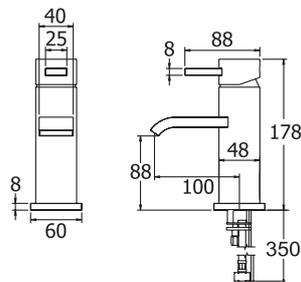

INLET CONNECTIONS:
1/2" BSP
WORKING PRESSURE:
0.2 – 5.0 bar

- Ceramic cartridge
- Tilt and turn temperature and flow control
- Comes complete with press top waste



LINX113 Chrome

Ex.VAT £148.65 Inc.VAT £178.38

LINX MINI MONO BASIN MIXER

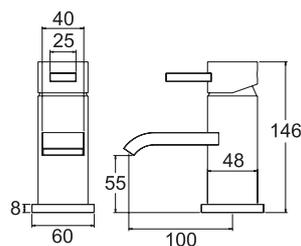

INLET CONNECTIONS:
1/2" BSP
WORKING PRESSURE:
0.2 – 5.0 bar

- Ceramic cartridge
- Tilt and turn temperature and flow control
- Also available with press top waste – see W code



water label L/Min **10.2**

LINX313 Chrome

Ex.VAT £123.88 Inc.VAT £148.66

LINX313W Chrome

Ex.VAT £136.60 Inc.VAT £163.92

LINX DECK MOUNTED BATH SHOWER MIXER

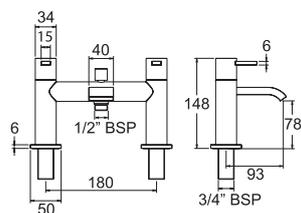

INLET CONNECTIONS:
3/4" BSP
WORKING PRESSURE:
0.5 – 5.0 bar

- Comes complete with single mode shower kit and wall bracket



LINX106 Chrome

Ex.VAT £222.98 Inc.VAT £267.58

LINX DECK MOUNTED BATH FILLER

INLET CONNECTIONS:
 $\frac{3}{4}$ " BSP
WORKING PRESSURE:
 0.2 – 5.0 bar

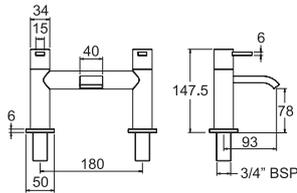

LINX108 Chrome

Ex.VAT £173.43 Inc.VAT £208.12

DEVA BATHROOM TAPS

LINX
 MONO
 BASIN
 MIXER



**12 YEAR
 GUARANTEE**
 ON ALL DEVA
 CHROME TAPS
*TERMS APPLY

DEVA BATHROOM TAPS

CRUX

CRUX MONO BASIN MIXER

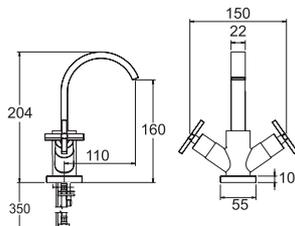

INLET CONNECTIONS:
1/2" BSP
WORKING PRESSURE:
0.2 – 5.0 bar

- Comes complete with press top waste



CRUX120 Chrome

Ex.VAT **£148.65** Inc.VAT **£178.38**

CRUX DECK MOUNTED BATH SHOWER MIXER

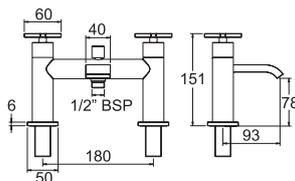

INLET CONNECTIONS:
3/4" BSP
WORKING PRESSURE:
0.2 – 5.0 bar

- Comes complete with single mode shower kit and wall bracket



CRUX106 Chrome

Ex.VAT **£222.98** Inc.VAT **£267.58**

CRUX DECK MOUNTED BATH FILLER

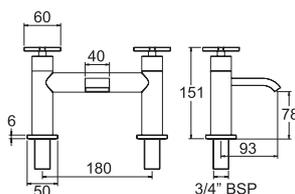

INLET CONNECTIONS:
3/4" BSP
WORKING PRESSURE:
0.2 – 5.0 bar



CRUX108 Chrome

Ex.VAT **£173.43** Inc.VAT **£208.12**



NEED IT TOMORROW?

NEXT DAY DELIVERY

ON ORDERS RECEIVED BEFORE 4PM*

*3pm on Fridays





MAXIMUM STYLE WITH OUR MINI MONOS

NOW AVAILABLE WITH CLICKER WASTE



Mini monos
are approximately
**20%
smaller**
than our standard monos with
no compromise on style or
performance

Vision	VSN313W	Ex.VAT	£118.31	Inc.VAT	£141.97
Sparkle	SPA313W	Ex.VAT	£170.02	Inc.VAT	£204.02
Insignia	INS313W	Ex.VAT	£83.51	Inc.VAT	£100.21
Linx	LINX313W	Ex.VAT	£136.60	Inc.VAT	£163.92
Savvi	SAVV313W	Ex.VAT	£120.87	Inc.VAT	£145.04
Elan	ELAN313W	Ex.VAT	£100.62	Inc.VAT	£120.74
Lace	LACE313W	Ex.VAT	£64.63	Inc.VAT	£77.56
Adore	ADORE313W	Ex.VAT	£64.63	Inc.VAT	£77.56



DEVA BATHROOM TAPS

RUBIC

RUBIC MONO BASIN MIXER

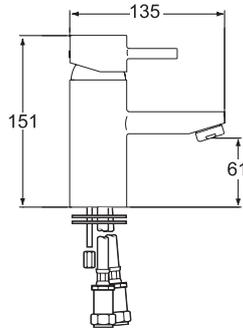

INLET CONNECTIONS:
1/2" BSP
WORKING PRESSURE:
0.5 – 5.0 bar

- Ceramic cartridge
- Tilt and turn temperature and flow control
- Comes complete with press top waste



RUB 113 Chrome

Ex.VAT £117.98 Inc.VAT £141.58

RUBIC BASIN TAPS

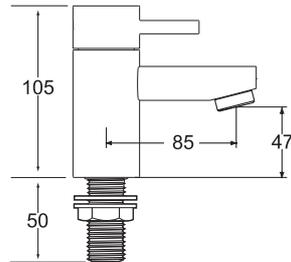

INLET CONNECTIONS:
1/2" BSP
WORKING PRESSURE:
0.1 – 5.0 bar



RUB 101 Chrome

Ex.VAT £93.21 Inc.VAT £111.85

RUBIC BATH TAPS

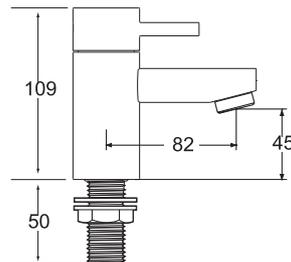

INLET CONNECTIONS:
3/4" BSP
WORKING PRESSURE:
0.3 – 5.0 bar



RUB 102 Chrome

Ex.VAT £105.59 Inc.VAT £126.71

RUBIC DECK MOUNTED BATH SHOWER MIXER

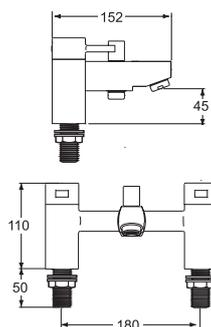

INLET CONNECTIONS:
3/4" BSP
WORKING PRESSURE:
0.5 – 5.0 bar

- Comes complete with single mode shower kit and wall bracket



RUB 106 Chrome

Ex.VAT £217.08 Inc.VAT £260.50

RUBIC DECK MOUNTED BATH FILLER

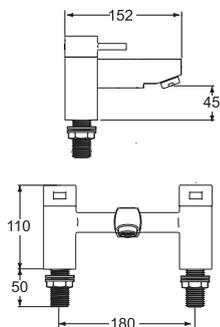

INLET CONNECTIONS:
3/4" BSP

WORKING PRESSURE:
0.5 – 5.0 bar



RUB 108 Chrome

Ex.VAT **£161.04** Inc.VAT **£193.25**

DEVA BATHROOM TAPS

ELAN

ELAN MONO BASIN MIXER

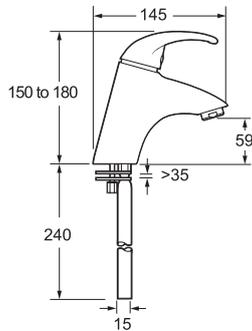

INLET CONNECTIONS:
1/2" BSP
WORKING PRESSURE:
0.3 – 5.0 bar

- Ceramic cartridge
- Tilt and turn temperature and flow control
- Comes complete with press top waste



ELAN113 Chrome

Ex.VAT **£105.59** Inc.VAT **£126.71**

ELAN MINI MONO BASIN MIXER

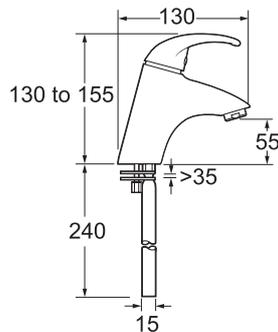

INLET CONNECTIONS:
15mm Copper
WORKING PRESSURE:
0.3 – 5.0 bar

- Ceramic cartridge
- Tilt and turn temperature and flow control
- Also available with press top waste – see W code



water label L/Min **18.0**

ELAN313 Chrome

Ex.VAT **£87.90** Inc.VAT **£105.48**

ELAN313W Chrome

Ex.VAT **£100.62** Inc.VAT **£120.74**

ELAN BASIN TAPS

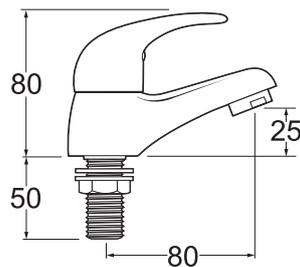

INLET CONNECTIONS:
1/2" BSP
WORKING PRESSURE:
0.2 – 5.0 bar



water label L/Min **43.8**

ELAN101 Chrome

Ex.VAT **£74.33** Inc.VAT **£89.20**

ELAN BATH TAPS

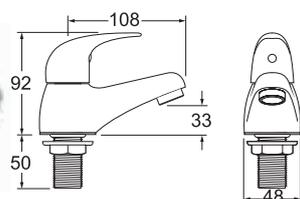

INLET CONNECTIONS:
3/4" BSP
WORKING PRESSURE:
0.3 – 5.0 bar



ELAN102 Chrome

Ex.VAT **£86.72** Inc.VAT **£104.06**

ELAN DECK MOUNTED BATH SHOWER MIXER

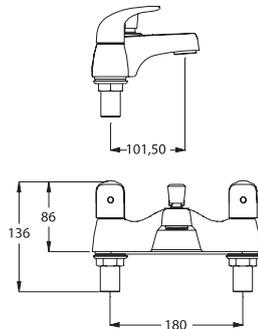

INLET CONNECTIONS:
3/4" BSP
WORKING PRESSURE:
0.5 – 5.0 bar

- Comes complete with single mode shower kit and wall bracket



ELAN106/DM Chrome

Ex.VAT £147.48 Inc.VAT £176.98

ELAN DECK MOUNTED BATH FILLER

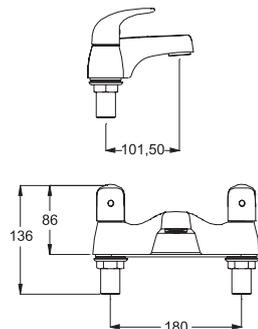

INLET CONNECTIONS:
3/4" BSP
WORKING PRESSURE:
0.3 – 5.0 bar



ELAN108 Chrome

Ex.VAT £117.98 Inc.VAT £141.58

DEVA BATHROOM TAPS

INSIGNIA

INSIGNIA MONO BASIN MIXER

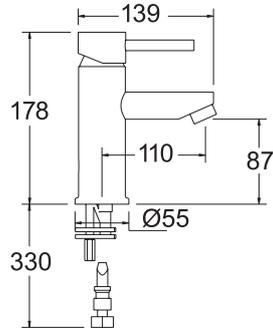

INLET CONNECTIONS:
½" BSP
WORKING PRESSURE:
0.2 – 5.0 bar

- Ceramic cartridge
- Tilt and turn temperature and flow control
- Comes complete with press top waste



water label L/Min **18.0**

INS113 Chrome

Ex.VAT **£99.10** Inc.VAT **£118.92**

INSIGNIA MONO BASIN MIXER

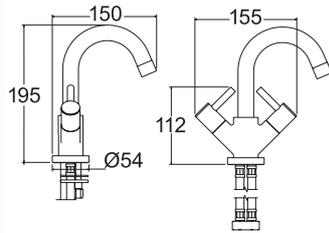

INLET CONNECTIONS:
½" BSP
WORKING PRESSURE:
0.2 – 5.0 bar

- Comes complete with press top waste



INS120 Chrome

Ex.VAT **£99.10** Inc.VAT **£118.92**

INSIGNIA MINI MONO BASIN MIXER

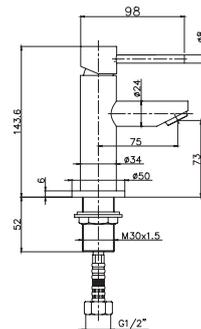

INLET CONNECTIONS:
½" BSP
WORKING PRESSURE:
0.2 – 5.0 bar

- Ceramic cartridge
- Tilt and turn temperature and flow control
- Also available with press top waste – see W code



water label L/Min **10.2**

INS313 Chrome

Ex.VAT **£70.79** Inc.VAT **£84.95**

INS313W Chrome

Ex.VAT **£83.51** Inc.VAT **£100.21**

INSIGNIA BASIN TAPS

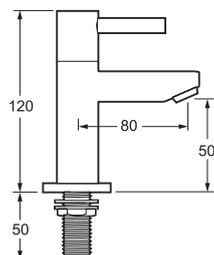

INLET CONNECTIONS:
½" BSP
WORKING PRESSURE:
0.2 – 5.0 bar

- Reduced water flow option available, see FR code



water label L/Min **8.0**

INS101 Chrome

Ex.VAT **£74.33** Inc.VAT **£89.20**

INS101/FR101-4 Chrome

Ex.VAT **£74.33** Inc.VAT **£89.20**

INSIGNIA BATH TAPS

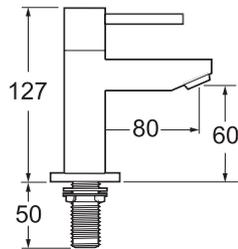

INLET CONNECTIONS:
3/4" BSP
WORKING PRESSURE:
0.2 – 5.0 bar



INS102 Chrome

Ex.VAT £86.72 Inc.VAT £104.06

INSIGNIA DECK MOUNTED BATH SHOWER MIXER

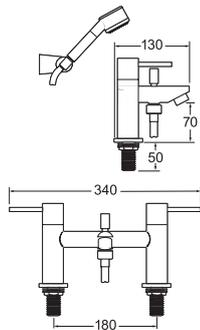

INLET CONNECTIONS:
3/4" BSP
WORKING PRESSURE:
0.5 – 5.0 bar

- Comes complete with single mode shower kit and wall bracket



INS106 Chrome

Ex.VAT £155.14 Inc.VAT £186.17

INSIGNIA DECK MOUNTED BATH FILLER

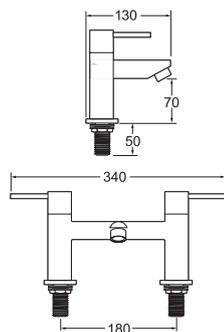

INLET CONNECTIONS:
3/4" BSP
WORKING PRESSURE:
0.2 – 5.0 bar



INS108 Chrome

Ex.VAT £136.26 Inc.VAT £163.51

DEVA BATHROOM TAPS

MOTIF

MOTIF MONO BASIN MIXER

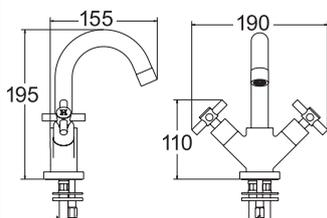

INLET CONNECTIONS:
1/2" BSP
WORKING PRESSURE:
0.2 – 5.0 bar

- Comes complete with press top waste



MOT113 Chrome

Ex.VAT £99.10 Inc.VAT £118.92

MOTIF BASIN TAPS

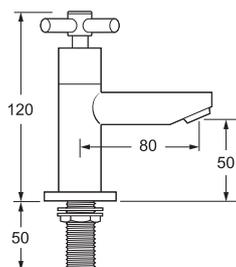

INLET CONNECTIONS:
1/2" BSP
WORKING PRESSURE:
0.2 – 5.0 bar



MOT101 Chrome

Ex.VAT £74.33 Inc.VAT £89.20

MOTIF BATH TAPS

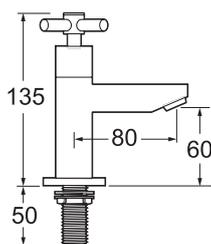

INLET CONNECTIONS:
3/4" BSP
WORKING PRESSURE:
0.2 – 5.0 bar



MOT102 Chrome

Ex.VAT £86.72 Inc.VAT £104.06

MOTIF DECK MOUNTED BATH SHOWER MIXER

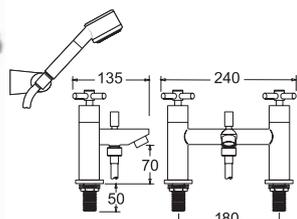

INLET CONNECTIONS:
3/4" BSP
WORKING PRESSURE:
0.2 – 5.0 bar

- Comes complete with single mode shower kit and wall bracket



MOT106 Chrome

Ex.VAT £155.14 Inc.VAT £186.17

MOTIF DECK MOUNTED BATH FILLER

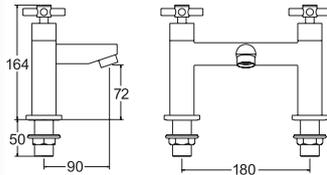

INLET CONNECTIONS:
3/4" BSP
WORKING PRESSURE:
0.2 – 5.0 bar



MOT108 Chrome

Ex.VAT £136.26 Inc.VAT £163.51

Type of measurement:
Flow rate value
identifies exact litres
per minute usage.

Performance Bands:
Rated 6 to 13 and above.



Actual capacity or
performance of the product
with flow rate saving.

Actual capacity or
performance of the product
without flow rate saving.

To save water, the savings device supplied must be fitted. Always refer to the manufacturer's instructions for guidance.

Type of measurement:
Flow rate value
identifies exact litres
per minute usage.



Actual capacity or
performance of the product
with flow rate saving.

Actual capacity or
performance of the product
without flow rate saving.

We offer a comprehensive range of showers and bathroom taps which meet industry standards for water efficiency. The scheme identifies products which when installed and used correctly, will use less water, saving energy and money. Look for the Water Label across our product range which identifies products that offer a water saving option.

Visit: www.europeanwaterlabel.eu for more information.

DEVA BATHROOM TAPS

LACE

LACE MONO BASIN MIXER

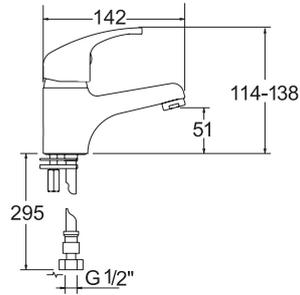

INLET CONNECTIONS:
1/2" BSP
WORKING PRESSURE:
0.2 – 5.0 bar

- Ceramic cartridge
- Tilt and turn temperature and flow control
- Comes complete with press top waste
- Enviro-klick (/EK) is a two step cartridge that offers 'full' and 'reduced' flow compared to a standard cartridge.



LACE113 Chrome

Ex.VAT £71.01 Inc.VAT £85.21

LACE113/EK Chrome

Ex.VAT £71.01 Inc.VAT £85.21

LACE MINI MONO BASIN MIXER

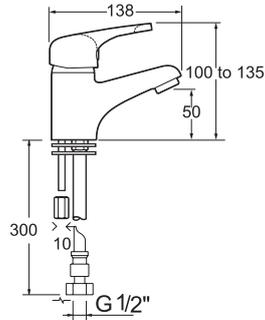

INLET CONNECTIONS:
1/2" BSP
WORKING PRESSURE:
0.3 – 5.0 bar

- Ceramic cartridge
- Tilt and turn temperature and flow control
- Also available with press top waste – see W code



LACE313 Chrome

Ex.VAT £51.43 Inc.VAT £61.72

LACE313W Chrome

Ex.VAT £64.63 Inc.VAT £77.56

LACE BIDET MIXER

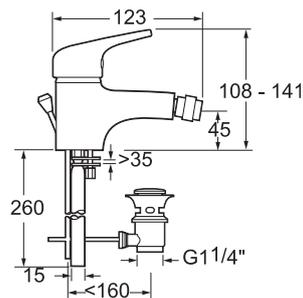

INLET CONNECTIONS:
1/2" BSP
WORKING PRESSURE:
0.3 – 5.0 bar

- Ceramic cartridge
- Tilt and turn temperature and flow control



LACE114 Chrome

Ex.VAT £102.84 Inc.VAT £123.41

LACE BASIN TAPS

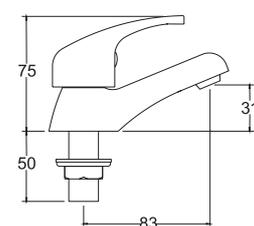

INLET CONNECTIONS:
1/2" BSP
WORKING PRESSURE:
0.2 – 5.0 bar



LACE101 Chrome

Ex.VAT £51.43 Inc.VAT £61.72

LACE BATH TAPS

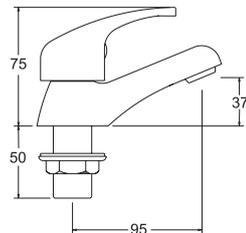

INLET CONNECTIONS:
3/4" BSP
WORKING PRESSURE:
0.2 – 5.0 bar



LACE102 Chrome

Ex.VAT £64.27 Inc.VAT £77.12

LACE DECK MOUNTED BATH SHOWER MIXER

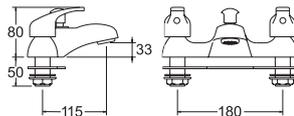

INLET CONNECTIONS:
3/4" BSP
WORKING PRESSURE:
0.5 – 5.0 bar

- Comes complete with single mode shower kit and wall bracket



LACE106 Chrome

Ex.VAT £122.43 Inc.VAT £146.92

LACE DECK MOUNTED BATH FILLER

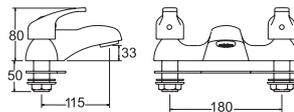

INLET CONNECTIONS:
3/4" BSP
WORKING PRESSURE:
0.5 – 5.0 bar



LACE108 Chrome

Ex.VAT £102.84 Inc.VAT £123.41

LACE
MONO BASIN
MIXER

**12 YEAR
GUARANTEE**
ON ALL DEVA
CHROME TAPS

*TERMS APPLY



DEVA BATHROOM TAPS

ADORE

ADORE MONO BASIN MIXER

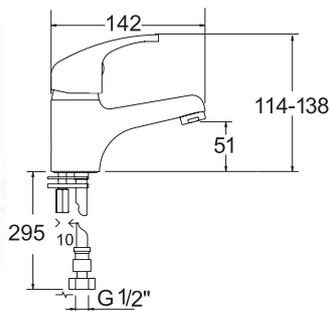

INLET CONNECTIONS:
1/2" BSP
WORKING PRESSURE:
0.2 – 5.0 bar

- Ceramic cartridge
- Tilt and turn temperature and flow control
- Comes complete with press top waste
- Enviro-klick (/EK) is a two step cartridge that offers 'full' and 'reduced' flow compared to a standard cartridge.



ADORE113 Chrome Ex.VAT £71.01 Inc.VAT £85.21

ADORE113/501 Gold Ex.VAT £107.73 Inc.VAT £129.28

ADORE113/EK Chrome Ex.VAT £71.01 Inc.VAT £85.21

ADORE MINI MONO BASIN MIXER

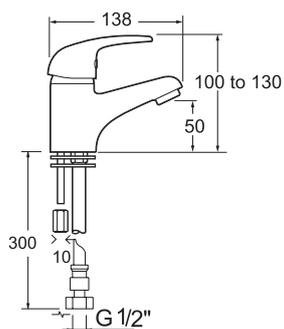

INLET CONNECTIONS:
1/2" BSP
WORKING PRESSURE:
0.3 – 5.0 bar

- Ceramic cartridge
- Tilt and turn temperature and flow control
- Also available with press top waste – see W code



ADORE313 Chrome Ex.VAT £51.43 Inc.VAT £61.72

ADORE313W Chrome Ex.VAT £64.63 Inc.VAT £77.56

ADORE BASIN TAPS

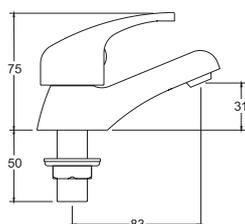

INLET CONNECTIONS:
1/2" BSP
WORKING PRESSURE:
0.2 – 5.0 bar



ADORE101 Chrome Ex.VAT £51.43 Inc.VAT £61.72

ADORE101/501 Gold Ex.VAT £81.62 Inc.VAT £97.94



ADORE BATH TAPS

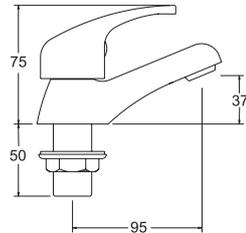

INLET CONNECTIONS:
3/4" BSP
WORKING PRESSURE:
0.2 – 5.0 bar



ADORE102 Chrome

Ex.VAT **£64.27** Inc.VAT **£77.12**

ADORE102/501 Gold

Ex.VAT **£88.77** Inc.VAT **£106.52**

ADORE DECK MOUNTED BATH SHOWER MIXER

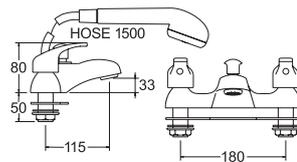

INLET CONNECTIONS:
3/4" BSP
WORKING PRESSURE:
0.5 – 5.0 bar

- Comes complete with single mode shower kit and wall bracket



ADORE106 Chrome

Ex.VAT **£122.43** Inc.VAT **£146.92**

ADORE106/501 Gold

Ex.VAT **£183.65** Inc.VAT **£220.38**

ADORE DECK MOUNTED BATH FILLER

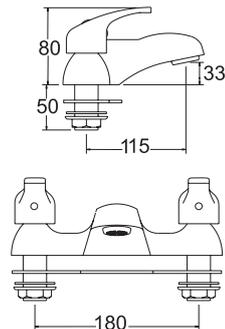

INLET CONNECTIONS:
3/4" BSP
WORKING PRESSURE:
0.5 – 5.0 bar



ADORE108 Chrome

Ex.VAT **£102.84** Inc.VAT **£123.41**

ADORE108/501 Gold

Ex.VAT **£151.81** Inc.VAT **£182.17**

ADORE MONO BASIN MIXER



12 YEAR
GUARANTEE

ON ALL DEVA
CHROME TAPS

*TERMS APPLY

DEVA BATHROOM TAPS

GEORGIAN

GEORGIAN MONO BASIN MIXER WITH POP UP WASTE

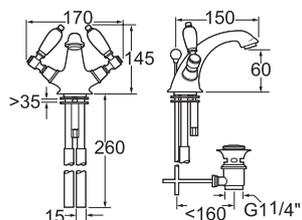

INLET CONNECTIONS:
15mm

WORKING PRESSURE:
0.1 – 5.0 bar



GE04 Chrome

Ex.VAT £185.82 Inc.VAT £222.98

GE04/501 Gold

Ex.VAT £229.56 Inc.VAT £275.47

GEORGIAN BASIN TAPS

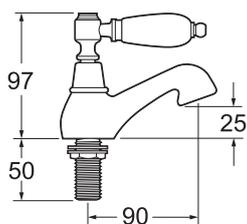

INLET CONNECTIONS:
1/2" BSP

WORKING PRESSURE:
0.1 – 5.0 bar



GE01 Chrome

Ex.VAT £93.21 Inc.VAT £111.85

GE01/501 Gold

Ex.VAT £121.21 Inc.VAT £145.45

GEORGIAN BATH TAPS

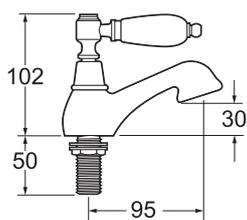

INLET CONNECTIONS:
3/4" BSP

WORKING PRESSURE:
0.3 – 5.0 bar



GE02 Chrome

Ex.VAT £111.49 Inc.VAT £133.79

GE02/501 Gold

Ex.VAT £140.18 Inc.VAT £168.22

GEORGIAN BIDET MIXER WITH POP UP WASTE

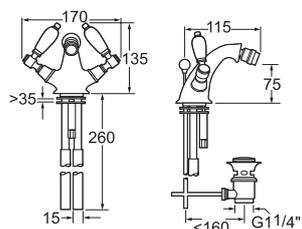

INLET CONNECTIONS:
15mm

WORKING PRESSURE:
0.1 – 5.0 bar



GE06 Chrome

Ex.VAT £136.26 Inc.VAT £163.51

GE06/501 Gold

Ex.VAT £178.13 Inc.VAT £213.76

GEORGIAN PILLAR MOUNTED BATH SHOWER MIXER

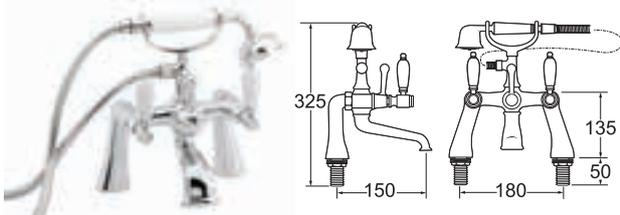

INLET CONNECTIONS:
3/4" BSP
WORKING PRESSURE:
0.3 – 5.0 bar

- Comes complete with single mode shower kit and wall bracket
- Product can be wall mounted or deck mounted.



GE03 Chrome

Ex.VAT **£408.79** Inc.VAT **£490.55**

GE03/501 Gold

Ex.VAT **£485.43** Inc.VAT **£582.52**

GEORGIAN PILLAR MOUNTED BATH FILLER

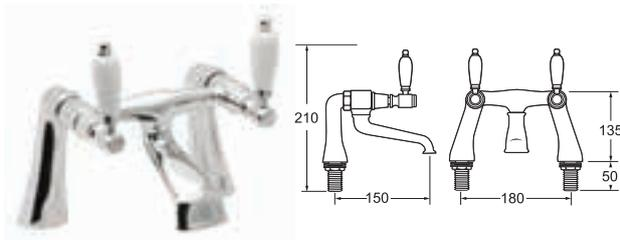

INLET CONNECTIONS:
3/4" BSP
WORKING PRESSURE:
0.3 – 5.0 bar

- Product can be wall or deck mounted



GE08 Chrome

Ex.VAT **£284.92** Inc.VAT **£341.90**

GE08/501 Gold

Ex.VAT **£344.64** Inc.VAT **£413.57**

GEORGIAN
PILLAR
MOUNTED BATH
SHOWER MIXER



DEVA BATHROOM TAPS

CORONATION

CORONATION MONO BASIN MIXER WITH POP UP WASTE

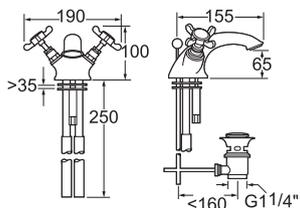

INLET CONNECTIONS:
1/2" BSP

WORKING PRESSURE:
0.1 – 5.0 bar



CR24 Chrome

Ex.VAT £155.14 Inc.VAT £186.17

CR24/501 Gold

Ex.VAT £197.73 Inc.VAT £237.28

CORONATION BASIN TAPS

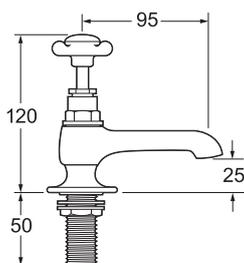

INLET CONNECTIONS:
1/2" BSP

WORKING PRESSURE:
0.1 – 5.0 bar



CR19 Chrome

Ex.VAT £74.33 Inc.VAT £89.20

CR19/501 Gold

Ex.VAT £101.62 Inc.VAT £121.94

CORONATION CLOAKROOM TAPS

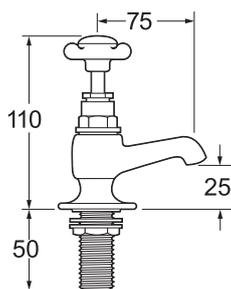

INLET CONNECTIONS:
1/2" BSP

WORKING PRESSURE:
0.1 – 5.0 bar



CR21 Chrome

Ex.VAT £71.96 Inc.VAT £86.35

CR21/501 Gold

Ex.VAT £99.17 Inc.VAT £119.00

CORONATION BATH TAPS

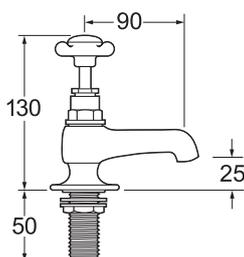

INLET CONNECTIONS:
3/4" BSP

WORKING PRESSURE:
0.1 – 5.0 bar



CR20 Chrome

Ex.VAT £93.21 Inc.VAT £111.85

CR20/501 Gold

Ex.VAT £121.21 Inc.VAT £145.45

CORONATION BIDET MIXER WITH POP UP WASTE

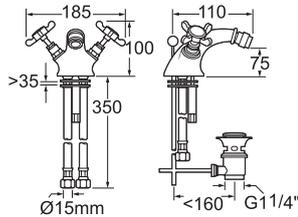

INLET CONNECTIONS:
15mm
WORKING PRESSURE:
0.1 – 5.0 bar



CR25 Chrome Ex.VAT **£173.43** Inc.VAT **£208.12**

CR25/501 Gold Ex.VAT **£216.70** Inc.VAT **£260.04**

CORONATION PILLAR MOUNTED BATH SHOWER MIXER

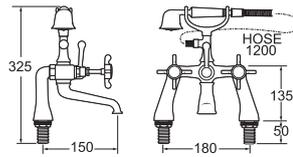

INLET CONNECTIONS:
¾" BSP
WORKING PRESSURE:
0.5 – 5.0 bar

- Comes complete with single mode shower kit and wall bracket



CR23 Chrome Ex.VAT **£309.69** Inc.VAT **£371.63**

CR23/501 Gold Ex.VAT **£382.59** Inc.VAT **£459.11**

CORONATION BATH FILLER

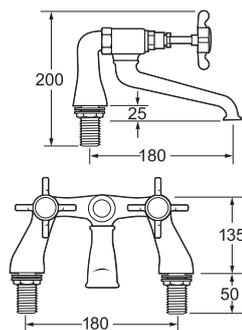

INLET CONNECTIONS:
¾" BSP
WORKING PRESSURE:
0.1 – 5.0 bar



CR26 Chrome Ex.VAT **£235.36** Inc.VAT **£282.43**

CR26/501 Gold Ex.VAT **£293.22** Inc.VAT **£351.86**

DEVA BATHROOM TAPS

TUDOR

TUDOR MONO BASIN MIXER WITH POP UP WASTE

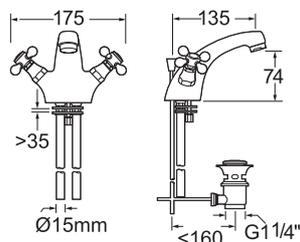

INLET CONNECTIONS:
15mm
WORKING PRESSURE:
0.1 – 5.0 bar



TUD113 Chrome Ex.VAT **£86.72** Inc.VAT **£104.06**

TUD113/501 Gold Ex.VAT **£126.72** Inc.VAT **£152.06**

TUDOR BASIN TAPS

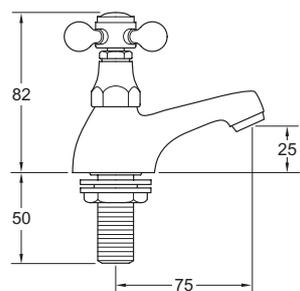

INLET CONNECTIONS:
½" BSP
WORKING PRESSURE:
0.1 – 5.0 bar



TUD01 Chrome Ex.VAT **£34.80** Inc.VAT **£41.76**

TUD01/501 Gold Ex.VAT **£60.60** Inc.VAT **£72.72**

TUDOR BATH TAPS

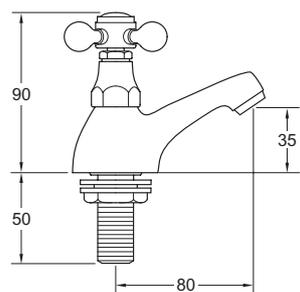

INLET CONNECTIONS:
¾" BSP
WORKING PRESSURE:
0.1 – 5.0 bar



TUD02 Chrome Ex.VAT **£37.16** Inc.VAT **£44.59**

TUD02/501 Gold Ex.VAT **£63.05** Inc.VAT **£75.66**

TUDOR BIDET MIXER WITH POP UP WASTE

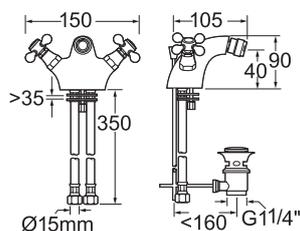

INLET CONNECTIONS:
½" BSP
WORKING PRESSURE:
0.1 – 5.0 bar



TUD114 Chrome Ex.VAT **£99.10** Inc.VAT **£118.92**

TUD114/501 Gold Ex.VAT **£139.57** Inc.VAT **£167.48**

TUDOR PILLAR MOUNTED BATH SHOWER MIXER

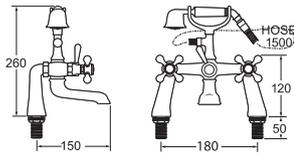

INLET CONNECTIONS:
3/4" BSP
WORKING PRESSURE:
0.3 – 5.0 bar

- Comes complete with single mode shower kit



TUD03 Chrome

Ex.VAT **£148.65** Inc.VAT **£178.38**

TUD03/501 Gold

Ex.VAT **£215.48** Inc.VAT **£258.58**

TUDOR PILLAR MOUNTED BATH FILLER

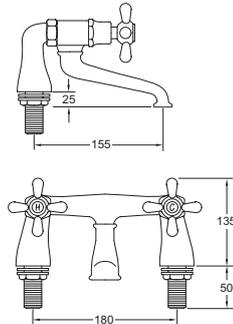

INLET CONNECTIONS:
3/4" BSP
WORKING PRESSURE:
0.3 – 5.0 bar



TUD08 Chrome

Ex.VAT **£117.98** Inc.VAT **£141.58**

TUD08/501 Gold

Ex.VAT **£171.40** Inc.VAT **£205.68**

TUDOR PILLAR MOUNTED BATH SHOWER MIXER



**12 YEAR
GUARANTEE**
ON ALL DEVA
CHROME TAPS

*TERMS APPLY

DEVA KITCHEN TAPS

CONTEMPORARY

DEVA KITCHEN TAPS

STR3AM
MONO
WATER
FILTER TAP



STR3AM MONO WATER FILTER TAP

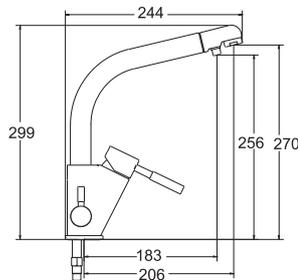

INLET CONNECTIONS:
1/2" BSP
WORKING PRESSURE:
0.5 – 5.0 bar

- Ceramic cartridge
- Features two separate outlets to prevent cross contamination of filtered water
- Drinking water outlet is filtered by a Deva water filter (FILTER 001). Replacement filter needed every 6 months
- Tilt and turn temperature and flow control



WFMS001 Chrome

Ex.VAT **£322.08** Inc.VAT **£386.50**

FILTER 001 White

Ex.VAT **£24.19** Inc.VAT **£29.03**

SLINKY MONO SINK MIXER

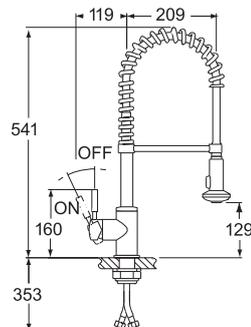

INLET CONNECTIONS:
1/2" BSP
WORKING PRESSURE:
1.0 – 5.0 bar

- Ceramic cartridge
- Swivel spout and pull out rinser
- Tilt and turn temperature and flow control
- Two functions – standard flow and spray



SLINKY118 Chrome

Ex.VAT **£279.01** Inc.VAT **£334.81**

VISION SINK MIXER WITH PULL OUT RINSER

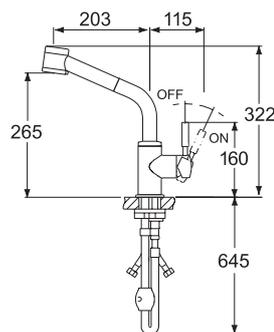

INLET CONNECTIONS:
1/2" BSP
WORKING PRESSURE:
1.0 – 5.0 bar

- Ceramic cartridge
- Swivel spout and pull out rinser
- Tilt and turn temperature and flow control
- Two functions – standard flow and spray



VSN115 Chrome

Ex.VAT **£222.98** Inc.VAT **£267.58**

FLUGEL MONO SINK MIXER

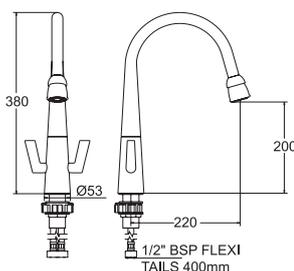

INLET CONNECTIONS:
1/2" BSP
WORKING PRESSURE:
1.0 – 5.0 bar

- Swivelling spout
- Adjustable spray for versatility



FLU115 Chrome

Ex.VAT **£222.98** Inc.VAT **£267.58**

DEVA KITCHEN TAPS

CONTEMPORARY

EDGE MONO SINK MIXER

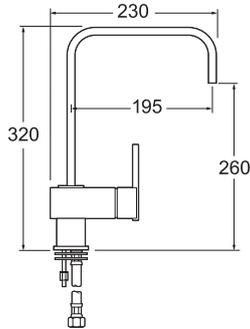

INLET CONNECTIONS:
1/2" BSP
WORKING PRESSURE:
1.5 – 5.0 bar

- Ceramic cartridge
- Tilt and turn temperature and flow control
- Swivel spout



water label L/Min **17.9**

EDGE118 Chrome

Ex.VAT **£210.59** Inc.VAT **£252.71**

SLINKY MINI MONO SINK MIXER

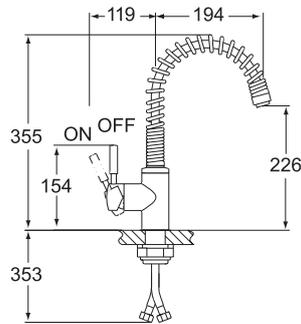

INLET CONNECTIONS:
1/2" BSP
WORKING PRESSURE:
1.0 – 5.0 bar

- Ceramic cartridge
- Tilt and turn temperature and flow control
- Swivel spout



SLINKY104 Chrome

Ex.VAT **£192.31** Inc.VAT **£230.77**

VISION MONO SINK MIXER WITH ARCH SPOUT

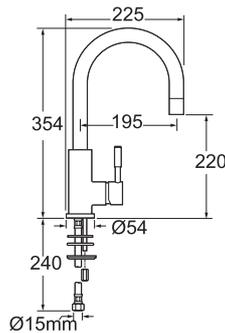

INLET CONNECTIONS:
15mm
WORKING PRESSURE:
0.3 – 5.0 bar

- Ceramic cartridge
- Tilt and turn temperature and flow control



VSN104 Chrome

Ex.VAT **£192.31** Inc.VAT **£230.77**

EDGE MONO SINK MIXER

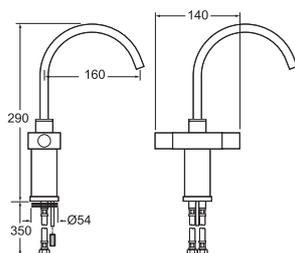

INLET CONNECTIONS:
1/2" BSP
WORKING PRESSURE:
0.5 – 5.0 bar

- Swivel spout



water label L/Min **10.2**

EDGE104 Chrome

Ex.VAT **£167.53** Inc.VAT **£201.04**

EXPRESSION MONO SINK MIXER

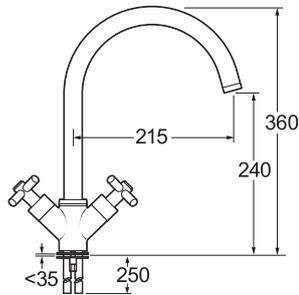

INLET CONNECTIONS:
1/2" BSP
WORKING PRESSURE:
0.2 – 5.0 bar

- Swivel spout



EPR104 Chrome

water label L/Min **26.5**

Ex.VAT £192.31 Inc.VAT £230.77

LACE SINGLE LEVER SINK MIXER WITH PULL OUT RINSER

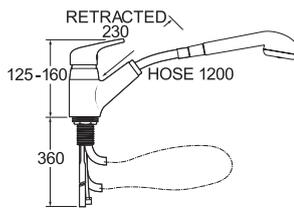

INLET CONNECTIONS:
15mm compression
WORKING PRESSURE:
1.0 – 5.0 bar

- Ceramic cartridge
- Swivel spout and pull out rinser
- 2 spray functions
- Tilt and turn temperature and flow control



LACE115 Chrome

water label L/Min **8.1**

Ex.VAT £199.56 Inc.VAT £239.47

TAURS MONO SINK MIXER

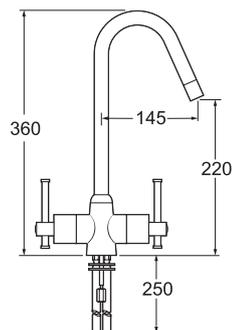

INLET CONNECTIONS:
1/2" BSP
WORKING PRESSURE:
0.3 – 5.0 bar

- Swivel spout



TAUR130 Chrome

Ex.VAT £147.48 Inc.VAT £176.98

METROPOLIS MONO SINK MIXER

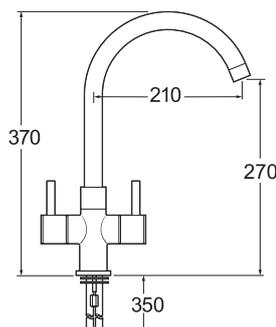

INLET CONNECTIONS:
1/2" BSP
WORKING PRESSURE:
0.3 – 5.0 bar

- Swivel spout



MET172 Chrome

water label L/Min **18.0**

Ex.VAT £141.57 Inc.VAT £169.88

DEVA KITCHEN TAPS

CONTEMPORARY

PUFFIN MONO SINK MIXER

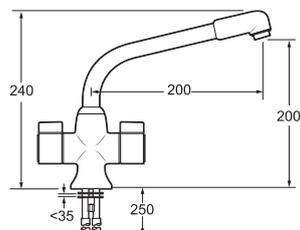

INLET CONNECTIONS:
1/2" BSP

WORKING PRESSURE:
0.2 – 5.0 bar

- Swivel spout and divided flow



PUF130/CP Chrome

Ex.VAT **£130.37** Inc.VAT **£156.44**

CONVERSE MONO SINK MIXER

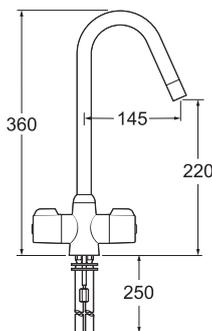

INLET CONNECTIONS:
1/2" BSP

WORKING PRESSURE:
0.3 – 5.0 bar

- Swivelling spout



CONV130 Chrome

Ex.VAT **£117.98** Inc.VAT **£141.58**

SAURIS MONO SINK MIXER

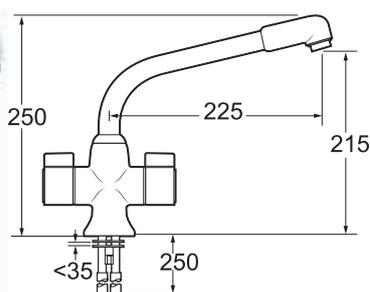

INLET CONNECTIONS:
1/2" BSP

WORKING PRESSURE:
0.2 – 5.0 bar

- Swivel spout
- Dual Flow



SMS172 Chrome

Ex.VAT **£105.59** Inc.VAT **£126.71**

SMS172/004 Beige

Ex.VAT **£123.88** Inc.VAT **£148.66**

SMS172/005 White

Ex.VAT **£123.88** Inc.VAT **£148.66**



MILAN MONO SINK MIXER

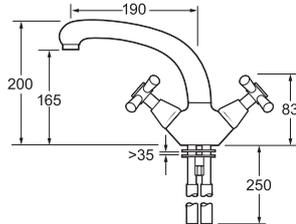

INLET CONNECTIONS:
1/2" BSP
WORKING PRESSURE:
0.1 – 5.0 bar

- Swivel spout
- Dual Flow



MILAN 104 Chrome

Ex.VAT **£101.46** Inc.VAT **£121.75**

LACE MONO SINK MIXER

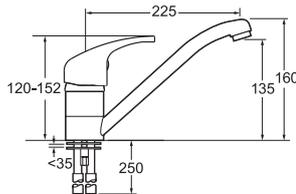

INLET CONNECTIONS:
1/2" BSP
WORKING PRESSURE:
0.2 – 5.0 bar

- Ceramic cartridge
- Tilt and turn temperature and flow control
- Swivel spout



LACE171 Chrome

Ex.VAT **£96.72** Inc.VAT **£116.06**

ADORE MONO SINK MIXER

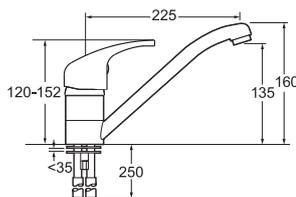

INLET CONNECTIONS:
1/2" BSP
WORKING PRESSURE:
0.2 – 5.0 bar

- Ceramic cartridge
- Tilt and turn temperature and flow control
- Swivel spout
- Enviro-klick version available see EK code



water label L/Min **21.4**

ADORE171 Chrome

Ex.VAT **£96.72** Inc.VAT **£116.06**

ADORE171/EK Chrome

Ex.VAT **£96.72** Inc.VAT **£116.06**

LEVER ACTION SINK TAPS

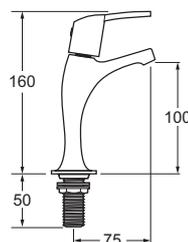

INLET CONNECTIONS:
1/2" BSP
WORKING PRESSURE:
0.1 – 5.0 bar



NLT103 Chrome

Ex.VAT **£72.08** Inc.VAT **£86.50**

DEVA KITCHEN TAPS

CONTEMPORARY

LEVER ACTION MONO SINK MIXER

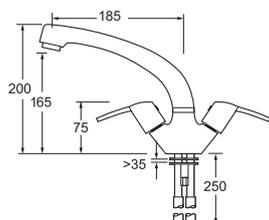

INLET CONNECTIONS:
15mm Copper
WORKING PRESSURE:
0.1 – 5.0 bar

- Swivel spout
- Dual Flow



NLT104 Chrome

Ex.VAT **£116.60** Inc.VAT **£139.92**

LEVER ACTION DECK MOUNTED SINK MIXER

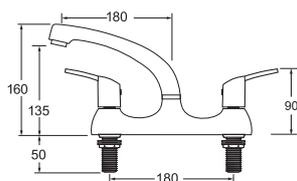

INLET CONNECTIONS:
1/2" BSP
WORKING PRESSURE:
0.1 – 5.0 bar

- Swivel spout
- Dual Flow



NLT105 Chrome

Ex.VAT **£103.88** Inc.VAT **£124.66**

MILAN DECK MOUNTED SINK MIXER

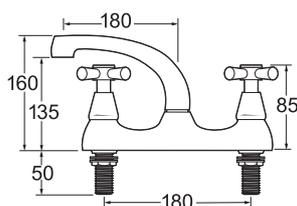

INLET CONNECTIONS:
1/2" BSP
WORKING PRESSURE:
0.1 – 5.0 bar

- Swivel spout
- Dual Flow



MILAN 105 Chrome

Ex.VAT **£76.69** Inc.VAT **£92.03**

LEVER MONO SINK MIXER

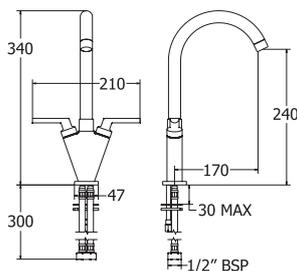

INLET CONNECTIONS:
1/2" BSP
WORKING PRESSURE:
0.3 – 5.0 bar

- Swivel spout
- Comes with under mount bracket



LEV104 Chrome

Ex.VAT **£68.42** Inc.VAT **£82.10**

MILAN SINK TAPS

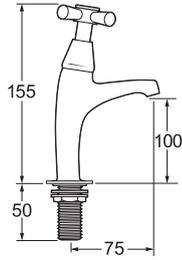

INLET CONNECTIONS:
½" BSP
WORKING PRESSURE:
0.1 – 5.0 bar



MILAN 103 Chrome

Ex.VAT £43.65 Inc.VAT £52.38

DEVA KITCHEN TAPS

CLASSIC

GEORGIAN MONO SINK MIXER

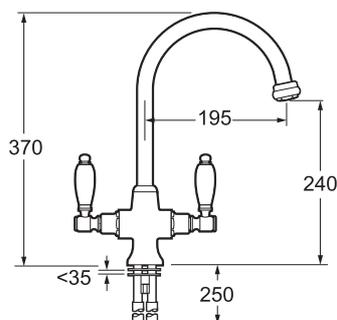

INLET CONNECTIONS:
15mm Copper
WORKING PRESSURE:
0.3 – 5.0 bar

- Swivel spout
- Dual Flow



SM056 Chrome	Ex.VAT £210.59 Inc.VAT £252.71
SM056/501 Gold	Ex.VAT £255.27 Inc.VAT £306.32
SM056/BZ Bronze	Ex.VAT £247.75 Inc.VAT £297.30
SM056/NI Nickel	Ex.VAT £316.18 Inc.VAT £379.42

GEORGIAN BRIDGE SINK MIXER

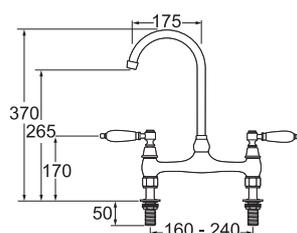

INLET CONNECTIONS:
½" BSP
WORKING PRESSURE:
0.1 – 5.0 bar

- Swivel spout
- Features adjustable centre pillars for easy installation



GEO305 Chrome	Ex.VAT £204.70 Inc.VAT £245.64
----------------------	--

CORONATION BRIDGE SINK MIXER

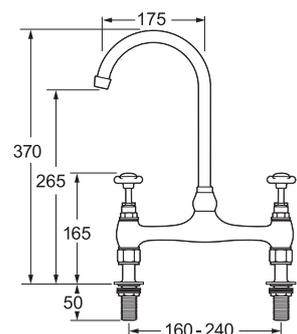

INLET CONNECTIONS:
½" BSP
WORKING PRESSURE:
0.1 – 5.0 bar

- Swivel spout
- Dual flow
- Features adjustable centre pillars for easy installation



CR305 Chrome	Ex.VAT £205.87 Inc.VAT £247.04
CR305/501 Gold	Ex.VAT £250.37 Inc.VAT £300.44

BRITTANY MONO SINK MIXER

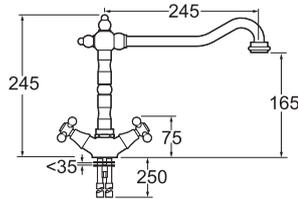

INLET CONNECTIONS:
1/2" BSP
WORKING PRESSURE:
0.1 – 5.0 bar

- Swivel spout



SM054 Chrome Ex.VAT **£167.53** Inc.VAT **£201.04**

SM054/501 Gold Ex.VAT **£210.58** Inc.VAT **£252.70**

CORONATION HIGH NECK SINK TAPS

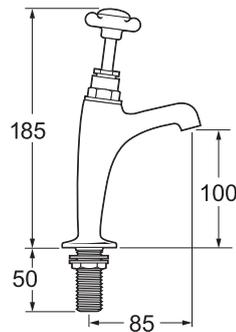

INLET CONNECTIONS:
1/2" BSP
WORKING PRESSURE:
0.1 – 5.0 bar

- 1/2" BS1010



CR27A Chrome Ex.VAT **£85.53** Inc.VAT **£102.64**

CR27A/501 Gold Ex.VAT **£113.25** Inc.VAT **£135.90**

VENETIAN MONO SINK MIXER

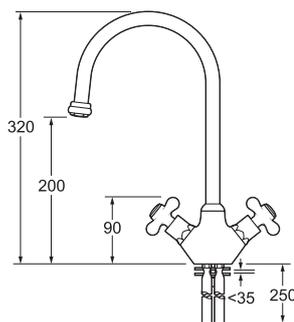

INLET CONNECTIONS:
1/2" BSP
WORKING PRESSURE:
0.1 – 5.0 bar

- Swivel spout
- Dual Flow



SM057 Chrome Ex.VAT **£111.49** Inc.VAT **£133.79**

SM057/501 Gold Ex.VAT **£152.43** Inc.VAT **£182.92**

SM057/NI Nickel Ex.VAT **£185.82** Inc.VAT **£222.98**

DEVA COMMERCIAL

MILAN

MILAN MONO BASIN MIXER WITH POP UP WASTE

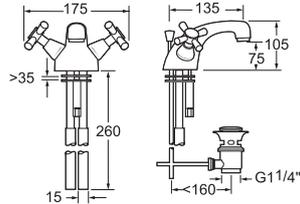

INLET CONNECTIONS:
15mm Copper
WORKING PRESSURE:
0.1 – 5.0 bar



MILAN 113 Chrome

Ex.VAT **£86.72** Inc.VAT **£104.06**

MILAN MONO BASIN MIXER WITH SWIVEL SPOUT AND POP UP WASTE

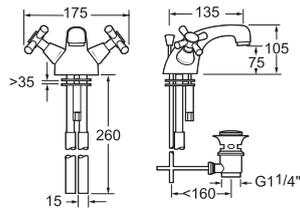

INLET CONNECTIONS:
15mm Copper
WORKING PRESSURE:
0.1 – 5.0 bar

- Swivelling spout



MILAN 113/SW Chrome

Ex.VAT **£93.21** Inc.VAT **£111.85**

MILAN BASIN TAPS

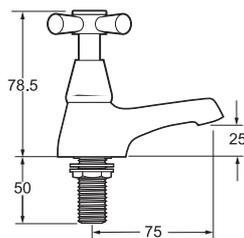

INLET CONNECTIONS:
1/2" BSP
WORKING PRESSURE:
0.1 – 5.0 bar

- Metal backnuts on SPEC codes



MILAN 101 Chrome

Ex.VAT **£35.39** Inc.VAT **£42.47**

MILAN SPEC101 Chrome

Ex.VAT **£38.35** Inc.VAT **£46.02**

MILAN BATH TAPS

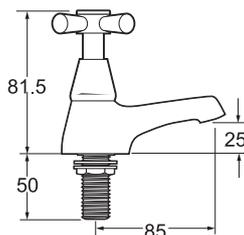

INLET CONNECTIONS:
3/4" BSP
WORKING PRESSURE:
0.1 – 5.0 bar

- Metal backnuts on SPEC codes



MILAN 102 Chrome

Ex.VAT **£39.53** Inc.VAT **£47.44**

MILAN SPEC102 Chrome

Ex.VAT **£42.48** Inc.VAT **£50.98**



MILAN DECK MOUNTED BATH SHOWER MIXER

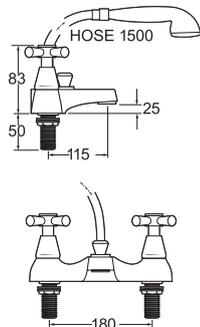

INLET CONNECTIONS:
3/4" BSP
WORKING PRESSURE:
0.1 – 5.0 bar

- Comes complete with single mode shower kit and wall bracket



MILAN 106 Chrome

Ex.VAT £123.88 Inc.VAT £148.66

MILAN DECK MOUNTED BATH FILLER

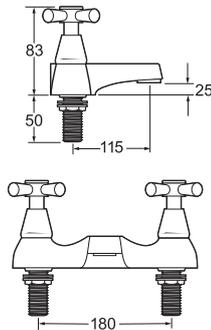

INLET CONNECTIONS:
3/4" BSP
WORKING PRESSURE:
0.1 – 5.0 bar

- Metal backnuts on SPEC codes



MILAN 108 Chrome

Ex.VAT £111.49 Inc.VAT £133.79

MILAN SPEC108 Chrome

Ex.VAT £115.04 Inc.VAT £138.05

MILAN MONO BASIN MIXER

**12 YEAR
GUARANTEE**
ON ALL DEVA
CHROME TAPS

*TERMS APPLY



DEVA COMMERCIAL SOLERNO

SOLERNO MONO BASIN MIXER WITH POP UP WASTE

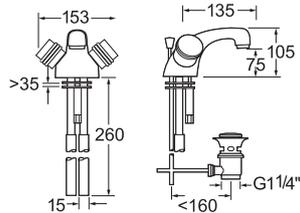

INLET CONNECTIONS:
15mm Copper
WORKING PRESSURE:
0.1 – 5.0 bar



SOLE113 Chrome

Ex.VAT £86.72 Inc.VAT £104.06

SOLERNO BASIN TAPS

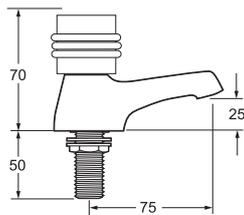

INLET CONNECTIONS:
1/2" BSP
WORKING PRESSURE:
0.1 – 5.0 bar



SOLE101 Chrome

Ex.VAT £35.39 Inc.VAT £42.47

SOLERNO BATH TAPS

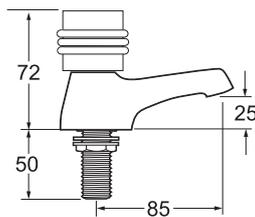

INLET CONNECTIONS:
3/4" BSP
WORKING PRESSURE:
0.1 – 5.0 bar



SOLE102 Chrome

Ex.VAT £40.70 Inc.VAT £48.84

SOLERNO DECK MOUNTED BATH SHOWER MIXER

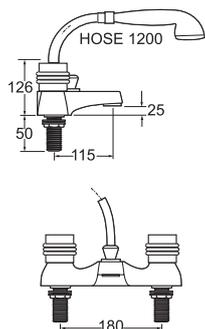

INLET CONNECTIONS:
3/4" BSP
WORKING PRESSURE:
0.1 – 5.0 bar

- Comes complete with single mode shower kit and wall bracket



SOLE106 Chrome

Ex.VAT £123.88 Inc.VAT £148.66

SOLERNO DECK MOUNTED BATH FILLER

INLET CONNECTIONS:
3/4" BSP
WORKING PRESSURE:
0.1 – 5.0 bar

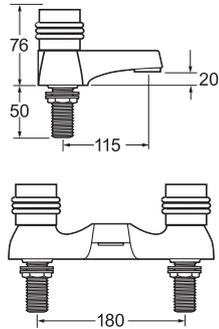

SOLE108 Chrome

Ex.VAT £111.49 Inc.VAT £133.79



SOLERNO
MONO
BASIN
MIXER

**12 YEAR
GUARANTEE**
ON ALL DEVA
CHROME TAPS
*TERMS APPLY

DEVA COMMERCIAL LEVER

CARE INDICE



Image shows indice on tap handle

- Suitable for use with DLT and DLV codes
- Full colour indices and raised 'H' and 'C' lettering
- Ideal for the care market and for users with impaired vision
- Sold in pairs

SP01/CARE DLT

Ex.VAT £2.34 Inc.VAT £2.81

LEVER ACTION 6" LEVER HANDLE OPTION

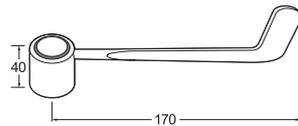

DLV002

Ex.VAT £36.00 Inc.VAT £43.20

LEVER ACTION MONO BASIN MIXER WITH POP UP WASTE

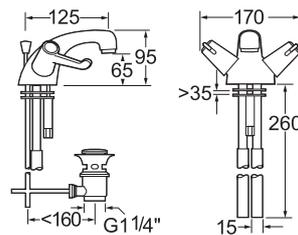

INLET CONNECTIONS:
15mm
WORKING PRESSURE:
0.1 – 5.0 bar



DLT113 Chrome

Ex.VAT £85.53 Inc.VAT £102.64

LEVER ACTION BIB TAPS

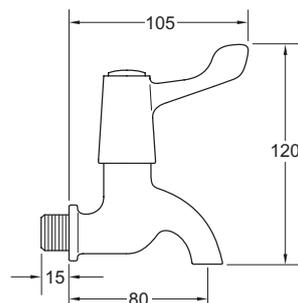

INLET CONNECTIONS:
1/2" BSP
WORKING PRESSURE:
0.1 – 5.0 bar

- DFV uses a 1/4 turn rising spindle



DLT095 Chrome

Ex.VAT £57.63 Inc.VAT £69.16

DFV095 Chrome

Ex.VAT £61.94 Inc.VAT £74.33



LEVER ACTION BASIN TAPS

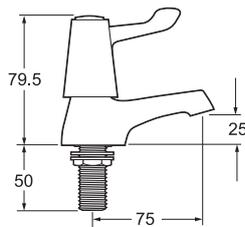

INLET CONNECTIONS:
1/2" BSP
WORKING PRESSURE:
0.1 – 5.0 bar

- Metal backnuts on SPEC code



DLT101 Chrome	Ex.VAT £35.39 Inc.VAT £42.47
DLT SPEC101 Chrome	Ex.VAT £38.34 Inc.VAT £46.01
DLV101 Chrome 6"	Ex.VAT £72.56 Inc.VAT £87.07

LEVER ACTION BATH TAPS

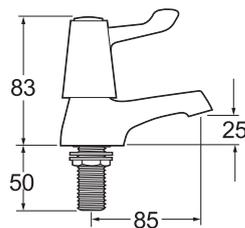

INLET CONNECTIONS:
3/4" BSP
WORKING PRESSURE:
0.1 – 5.0 bar

- Metal backnuts on SPEC codes



DLT102 Chrome	Ex.VAT £38.93 Inc.VAT £46.72
DLT SPEC102 Chrome	Ex.VAT £41.88 Inc.VAT £50.26
DLV102 Chrome 6"	Ex.VAT £76.10 Inc.VAT £91.32

DEVA COMMERCIAL LEVER

LEVER ACTION DECK MOUNTED BATH SHOWER MIXER

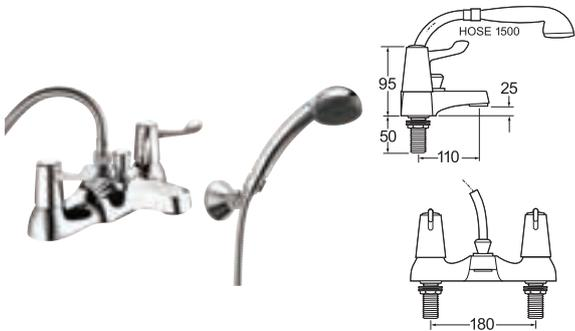

INLET CONNECTIONS:
3/4" BSP
WORKING PRESSURE:
0.3 – 5.0 bar

- Comes complete with single mode shower kit and wall bracket
- Metal backnuts on SPEC code



DLT106 Chrome Ex.VAT £120.34 Inc.VAT £144.41

DLT SPEC106 Chrome Ex.VAT £123.29 Inc.VAT £147.95

LEVER ACTION DECK MOUNTED BATH FILLER

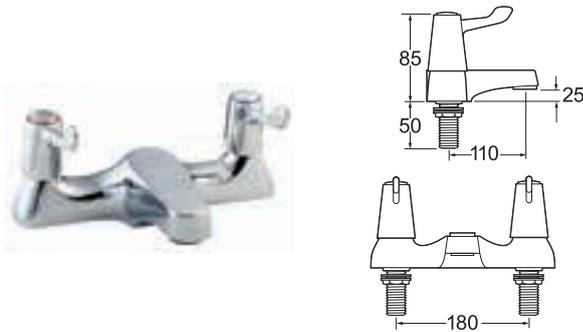

INLET CONNECTIONS:
3/4" BSP
WORKING PRESSURE:
0.2 – 5.0 bar



DLT108 Chrome Ex.VAT £99.10 Inc.VAT £118.92

LEVER ACTION SINK TAPS

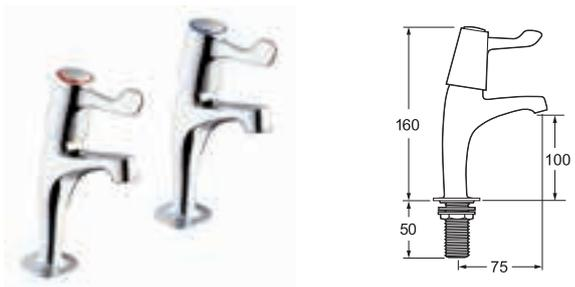

INLET CONNECTIONS:
1/2" BSP
WORKING PRESSURE:
0.1 – 5.0 bar

- Metal backnuts on SPEC codes



DLT103 Chrome Ex.VAT £38.93 Inc.VAT £46.72

DLT SPEC103 Chrome Ex.VAT £41.88 Inc.VAT £50.26

DLV103 Chrome 6" Ex.VAT £76.10 Inc.VAT £91.32

LEVER ACTION DECK MOUNTED SINK MIXER

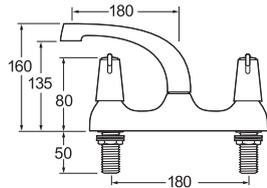

INLET CONNECTIONS:
1/2" BSP
WORKING PRESSURE:
0.1 – 5.0 bar

- Swivel spout
- Dual Flow
- Metal backnuts on SPEC codes



DLT105 Chrome Ex.VAT £73.15 Inc.VAT £87.78

DLV105 Chrome 6" Ex.VAT £111.49 Inc.VAT £133.79

DLT SPEC105 Chrome Ex.VAT £76.10 Inc.VAT £91.32

LEVER ACTION MONO SINK MIXER

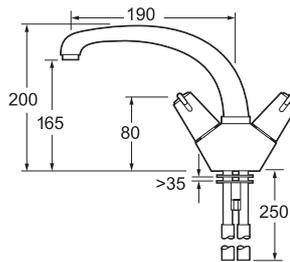

INLET CONNECTIONS:
15mm Copper
WORKING PRESSURE:
0.1 – 5.0 bar

- Swivel spout
- Dual Flow



DLT104 Chrome Ex.VAT £97.92 Inc.VAT £117.50

LEVER ACTION 3" LEVER BRIDGE SINK MIXER - WITH ADJUSTABLE CENTRES

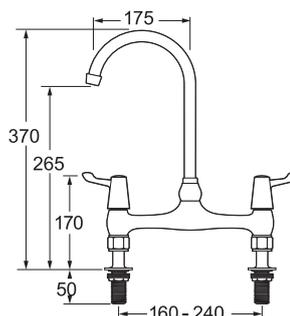

INLET CONNECTIONS:
1/2" BSP
WORKING PRESSURE:
0.2 – 5.0 bar

- Swivel spout
- Dual Flow
- Adjustable leg centres



DLT305B Chrome Ex.VAT £140.40 Inc.VAT £168.48

DEVA COMMERCIAL LEVER

LEVER ACTION 6" LEVER BRIDGE SINK MIXER WITH ADJUSTABLE CENTRES

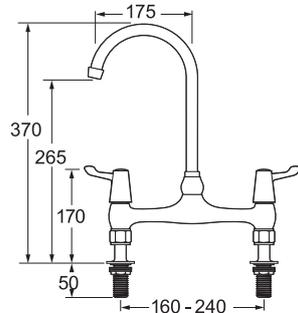

INLET CONNECTIONS:
1/2" BSP
WORKING PRESSURE:
0.2 – 5.0 bar

- Swivel spout
- Dual Flow
- Adjustable leg centres



DLV305B Chrome

Ex.VAT **£185.82** Inc.VAT **£222.98**

LEVER WALL MOUNTED BRIDGE SINK MIXER 6" LEVERS

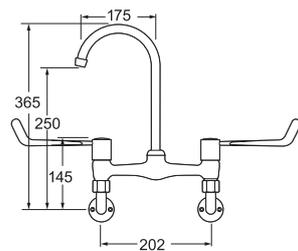

INLET CONNECTIONS:
1/2" BSP
WORKING PRESSURE:
0.2 – 5.0 bar

- Swivel spout
- Dual Flow



DLV305WM Chrome

Ex.VAT **£192.31** Inc.VAT **£230.77**

LEVER ACTION 3" CONVERSION KIT

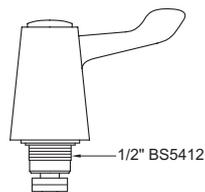

INLET CONNECTIONS:
1/2" BSP
WORKING PRESSURE:
0.2 – 5.0 bar

- Fits BS5412 taps



DLTKIT Chrome

Ex.VAT **£41.94** Inc.VAT **£50.33**

LEVER ACTION SEQUENTIAL CONTROL SPRAY MONO MIXER

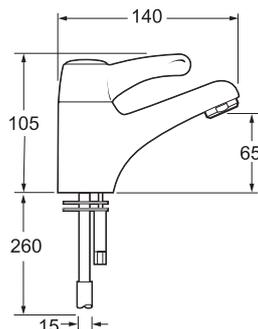

INLET CONNECTIONS:
15mm Copper
WORKING PRESSURE:
0.2 – 5.0 bar

- Includes spray feature to reduce water wastage
- Sold as a single mixer tap
- Operates under unequal pressure
- Product comes with copper and flexi tails



SOL002B Chrome

Ex.VAT **£198.20** Inc.VAT **£237.84**

LEVER ACTION BASIN TAPS

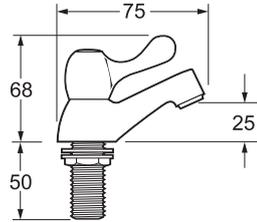

INLET CONNECTIONS:
1/2" BSP
WORKING PRESSURE:
0.1 – 5.0 bar



CNTL01 Chrome

Ex.VAT **£38.93** Inc.VAT **£46.72**

LEVER ACTION BATH TAPS

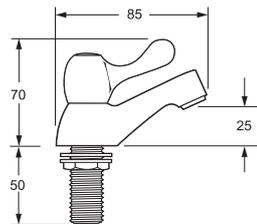

INLET CONNECTIONS:
3/4" BSP
WORKING PRESSURE:
0.3 – 5.0 bar



CNTL02 Chrome

Ex.VAT **£44.83** Inc.VAT **£53.80**

LEVER ACTION CONTRACT SINK PILLAR TAPS

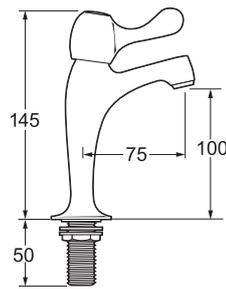

INLET CONNECTIONS:
1/2" BSP
WORKING PRESSURE:
0.1 – 5.0 bar



CNTL03 Chrome

Ex.VAT **£44.83** Inc.VAT **£53.80**

DEVA COMMERCIAL

CROSS HANDLE

CROSS HANDLE BASIN TAPS

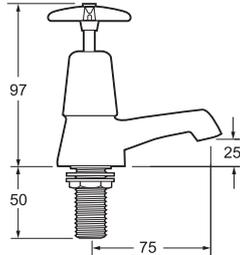

INLET CONNECTIONS:
1/2" BSP
WORKING PRESSURE:
0.1 – 5.0 bar

- Additional set of red and blue indices included



181X Chrome

Ex.VAT £29.50 Inc.VAT £35.40

CROSS HANDLE BATH TAPS

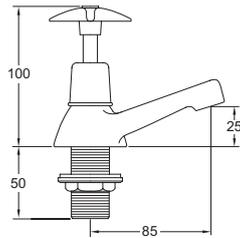

INLET CONNECTIONS:
3/4" BSP
WORKING PRESSURE:
0.1 – 5.0 bar

- Additional set of red and blue indices included



182X Chrome

Ex.VAT £31.26 Inc.VAT £37.51

CROSS HANDLE 1/2" BS5412 VALVE BIB TAPS

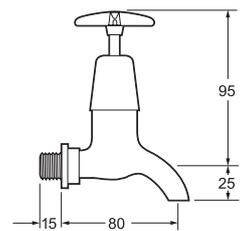

INLET CONNECTIONS:
1/2" BSP
WORKING PRESSURE:
0.1 – 5.0 bar

- Conforms to BS5412 standard
- Additional set of red and blue indices included



095X Chrome

Ex.VAT £29.50 Inc.VAT £35.40

CROSS HANDLE DECK MOUNTED BATH SHOWER MIXER

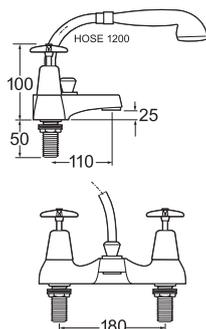

INLET CONNECTIONS:
3/4" BSP
WORKING PRESSURE:
0.1 – 5.0 bar

- Comes complete with single mode shower kit and wall bracket
- Conforms to BS5412 standard
- Additional set of red and blue indices included



186X Chrome

Ex.VAT £117.98 Inc.VAT £141.58



CROSS HANDLE DECK MOUNTED SINK MIXER

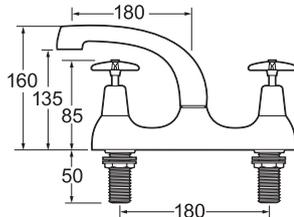

INLET CONNECTIONS:
½" BSP
WORKING PRESSURE:
0.1 – 5.0 bar

- Conforms to BS5412 standard
- Swivelling spout
- Dual Flow
- Additional set of red and blue indices included



187X Chrome

Ex.VAT **£56.04** Inc.VAT **£67.25**

CROSS HANDLE SINK TAPS

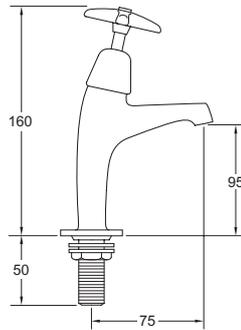

INLET CONNECTIONS:
½" BSP
WORKING PRESSURE:
0.1 – 5.0 bar

- Additional set of red and blue indices included



183X Chrome

Ex.VAT **£32.45** Inc.VAT **£38.94**

DEVA COMMERCIAL PROFILE

PROFILE MONO BASIN MIXER WITH POP UP WASTE

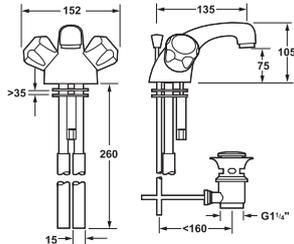

INLET CONNECTIONS:
15mm Copper
WORKING PRESSURE:
0.1 – 5.0 bar



DCM113 Chrome	Ex.VAT £60.76 Inc.VAT £72.91
DCM113/501 Gold	Ex.VAT £99.78 Inc.VAT £119.74

PROFILE MONO BASIN MIXER

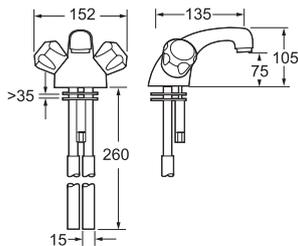

INLET CONNECTIONS:
15mm Copper
WORKING PRESSURE:
0.1 – 5.0 bar

- Includes chain stay
- Waste supplied separately, see wastes and spares section



DCM113B Chrome	Ex.VAT £56.04 Inc.VAT £67.25
-----------------------	--

PROFILE BASIN TAPS

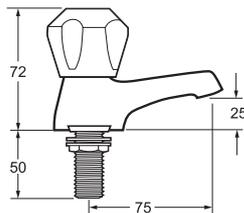

INLET CONNECTIONS:
1/2" BSP
WORKING PRESSURE:
0.1 – 5.0 bar

- Metal backnuts on SPEC code



DCM101 Chrome	Ex.VAT £22.42 Inc.VAT £26.90
DCM SPEC101 Chrome	Ex.VAT £25.37 Inc.VAT £30.44
DCM101/501 Gold	Ex.VAT £47.75 Inc.VAT £57.30

PROFILE BATH TAPS

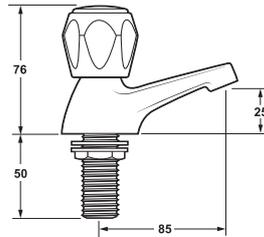

INLET CONNECTIONS:
3/4" BSP
WORKING PRESSURE:
0.1 – 5.0 bar

- Metal backnuts on SPEC code



DCM102 Chrome	Ex.VAT £24.19 Inc.VAT £29.03
DCM SPEC102 Chrome	Ex.VAT £27.14 Inc.VAT £32.57
DCM102/501 Gold	Ex.VAT £49.59 Inc.VAT £59.51

PROFILE DECK MOUNTED BATH SHOWER MIXER

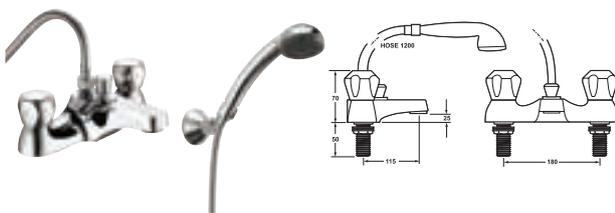

INLET CONNECTIONS:
3/4" BSP
WORKING PRESSURE:
0.1 – 5.0 bar

- Comes complete with single mode shower kit and wall bracket



DCM106 Chrome	Ex.VAT £90.84 Inc.VAT £109.01
DCM106/501 Gold	Ex.VAT £155.49 Inc.VAT £186.59

PROFILE DECK MOUNTED BATH FILLER

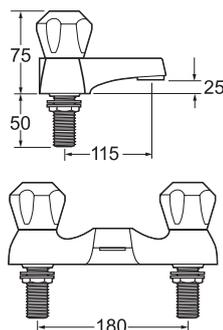

INLET CONNECTIONS:
3/4" BSP
WORKING PRESSURE:
0.1 – 5.0 bar



DCM108 Chrome	Ex.VAT £71.96 Inc.VAT £86.35
DCM108/501 Gold	Ex.VAT £123.65 Inc.VAT £148.38

DEVA COMMERCIAL PROFILE

PROFILE DECK MOUNTED SINK MIXER

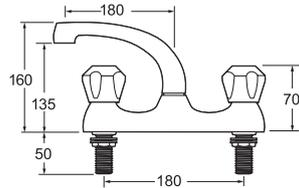

INLET CONNECTIONS:
½" BSP
WORKING PRESSURE:
0.1 – 5.0 bar

- Swivel spout
- Metal backnuts on SPEC codes
- Dual Flow



DCM105 Chrome Ex.VAT **£56.04** Inc.VAT **£67.25**

DCM SPEC105 Chrome Ex.VAT **£58.99** Inc.VAT **£70.79**

PROFILE MONO SINK MIXER

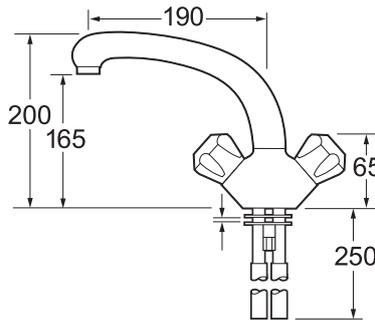

INLET CONNECTIONS:
15mm Copper
WORKING PRESSURE:
0.1 – 5.0 bar

- Swivelling spout
- Dual Flow



DCM104 Chrome Ex.VAT **£65.48** Inc.VAT **£78.58**

DCP124/004 Beige Ex.VAT **£86.72** Inc.VAT **£104.06**

DCP124/005 White Ex.VAT **£86.72** Inc.VAT **£104.06**

PROFILE SINK TAPS

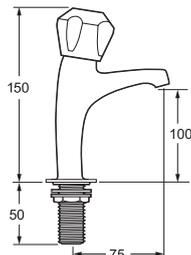

INLET CONNECTIONS:
½" BSP
WORKING PRESSURE:
0.1 – 5.0 bar

- Metal backnuts on SPEC codes



DCM103 Chrome Ex.VAT **£28.91** Inc.VAT **£34.69**

DCM SPEC103 Chrome Ex.VAT **£31.85** Inc.VAT **£38.22**

PROFILE CONTRACT MONO SINK MIXER

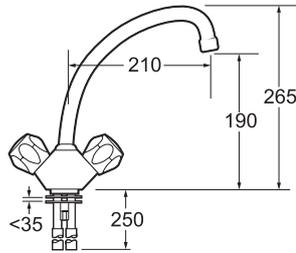

INLET CONNECTIONS:
15mm Copper
WORKING PRESSURE:
0.1 – 5.0 bar

- Swivel spout
- Dual Flow



CMS191 Chrome

Ex.VAT **£65.48** Inc.VAT **£78.58**

CMS191/002 Mocha

Ex.VAT **£86.72** Inc.VAT **£104.06**



**INCLUSIVE
DESIGN
SAFE & SIMPLE
TO MAKE LIFE
EASIER**



With an ageing population and some 10% of the population registered disabled, we understand the importance of developing new products which factor in the special needs of these groups and which optimise safety and ease of use.

We offer a range of taps and showers with features such as lever handles or sensor operation to optimise ease of use and enable daily tasks to be undertaken as safely as possible. In addition to ease of use, safety is paramount. Hot water can cause a serious scald injury within a matter of seconds, it is the second most common cause of scald injuries and children under the age of 5, the physically impaired, and adults over the age of 65 are amongst those at highest risk.

We offer a number of products aimed at minimising the risk of scalding. The thermostatic control facility of these products ensures that water temperature does not exceed the pre-set maximum.

Look for these symbols identifying those products which make life easier, feature thermostatic control, cool to touch and those which have been tested to TMV2 or TMV3 Buildcert thermostatic standards.



DEVA COMMERCIAL

NON CONCUSSIVE & SHATAFS

NON CONCUSSIVE VISION SELF CLOSING BASIN TAP

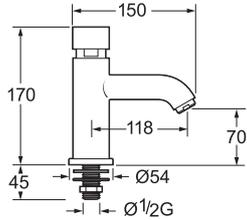

INLET CONNECTIONS:
1/2" BSP
WORKING PRESSURE:
0.3 – 5.0 bar

- Sold as singles
- Pre set automatic shut off after approximately 10 seconds
- Recommended for use with a blending valve see page 149



water label L/Min **7.3**

VSN123 Chrome

Ex.VAT £111.49 Inc.VAT £133.79

NON CONCUSSIVE PRE-SET BASIN TAPS

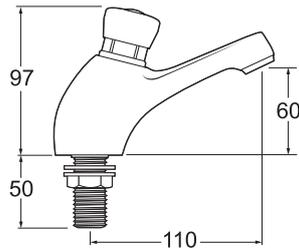

INLET CONNECTIONS:
1/2" BSP
WORKING PRESSURE:
0.1 - 3.0 bar

- Self closing deck basin taps
- Pre-set automatic shut off after approximately 10 seconds



water label L/Min **15.2**

NCT001 Chrome

Ex.VAT £68.42 Inc.VAT £82.10

NON CONCUSSIVE SELF CLOSING PILLAR BASIN TAP

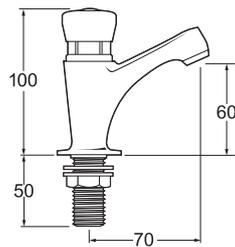

INLET CONNECTIONS:
1/2" BSP
WORKING PRESSURE:
0.2 – 5.0 bar

- 1/2" self-closing deck basin tap (single)
- Pre-set automatic shut off after approximately 10 seconds
- Sold as singles
- Hot & cold indices supplied



water label L/Min **12.4**

CORM03 Chrome

Ex.VAT £31.26 Inc.VAT £37.51

SHATTAF WITH HOSE AND WALL BRACKET

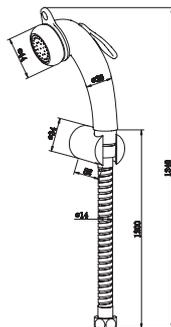

INLET CONNECTIONS:
1/2" BSP
WORKING PRESSURE:
0.5 – 5.0 bar

- Includes 1.2m metal hose & ABS wall bracket



SHA01 Chrome

Ex.VAT £17.79 Inc.VAT £21.35



BRASS SHATTAF WITH HOSE AND WALL BRACKET

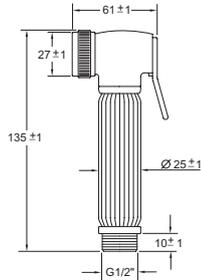

INLET CONNECTIONS:
1/2" BSP
WORKING PRESSURE:
0.5 – 5.0 bar

- Includes 1.2m metal hose & ABS wall bracket



SHA02 Chrome



Ex.VAT **£27.16** Inc.VAT **£32.59**

NON CONCUSSIVE PRE-SET EXPOSED SHOWER VALVE

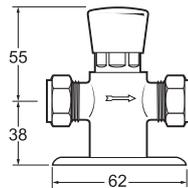

VALVE:
Manual
INLET CONNECTIONS:
15mm Copper
WORKING PRESSURE:
0.2 – 5.0 bar

- Suitable for swimming baths, leisure clubs etc
- Pre-set automatic shut off after approximately 20 seconds



NCT002 Chrome



Ex.VAT **£74.33** Inc.VAT **£89.20**

NON CONCUSSIVE PRE-SET RECESSED SHOWER VALVE

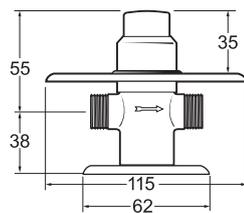

VALVE:
Manual
INLET CONNECTIONS:
15mm Copper
WORKING PRESSURE:
0.2 – 5.0 bar

- Suitable for swimming baths, leisure clubs etc
- Pre-set automatic shut off after approximately 20 seconds



NCT003 Chrome



Ex.VAT **£80.81** Inc.VAT **£96.97**

ANTI-VANDAL SHOWER HEAD

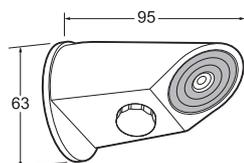

INLET CONNECTIONS:
15mm Copper

- 9 L/min flow regulator available, FRAV 9
- Sturdy brass construction and compact rounded shape for both style and durability
- Suitable for prisons, sports centres, public facilities etc



AVSH001 Chrome

Ex.VAT **£74.33** Inc.VAT **£89.20**

DEVA COMMERCIAL THERMOSTATIC

THERMOSTATIC TMV3 SEQUENTIAL LEVER MONO BASIN MIXER

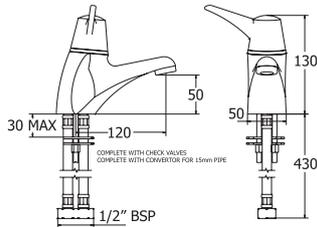

INLET CONNECTIONS:
1/2" BSP
WORKING PRESSURE:
0.2 – 5.0 bar

- Ultimate thermostatic performance to TMV3 Buildcert standards
- Sequential flow and temperature control for ease of use



SOL003 Chrome

Ex.VAT £247.75 Inc.VAT £297.30

THERMOSTATIC BATH SHOWER MIXER

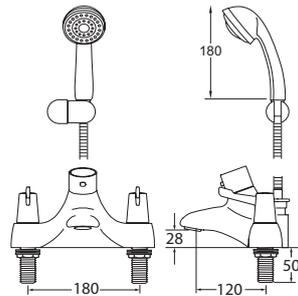

INLET CONNECTIONS:
3/4" BSP
WORKING PRESSURE:
0.1 – 5.0 bar

- Approved as low pressure designation
- Thermostatic to the bath and the shower
- Prevents scalding by accurately controlling the water temperature
- Lever handle options for ease of use



DLT TSM 106 Chrome

Ex.VAT £684.87 Inc.VAT £821.84

DYNAMIC PILLAR MOUNTED THERMOSTATIC BATH SHOWER MIXER

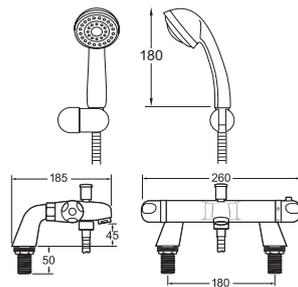

INLET CONNECTIONS:
3/4" BSP
WORKING PRESSURE:
1.0 – 5.0 bar

- Comes complete with single mode shower kit and wall bracket



DYN 106 Chrome

Ex.VAT £247.75 Inc.VAT £297.30

PRESSURE EQUALISING VALVE

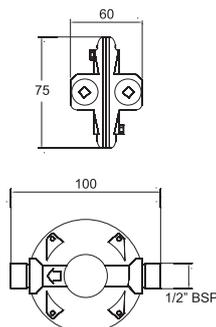

INLET CONNECTIONS:
1/2" BSP
WORKING PRESSURE:
0.2 – 5.0 bar

- The valve equalises the outlet pressure, by automatically adjusting the higher inlet pressure to level out the lower inlet pressure



PEV002 Brass

Ex.VAT £102.05 Inc.VAT £122.46

THERMOSTATIC 28MM BLENDING VALVE

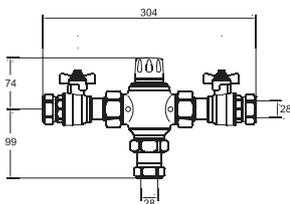

VALVE:
Thermostatic
INLET CONNECTIONS:
28mm Compression
WORKING PRESSURE:
0.2 – 5.0 bar

- Prevents scalding by accurately controlling the water temperature
- Adjustable outlet temperature
- Tamper proof head
- High flow rate
- For use where high volume of water is required eg shower blocks



TBV009 Chrome

Ex.VAT £867.14 Inc.VAT £1,040.57

THERMOSTATIC 22MM BLENDING VALVE

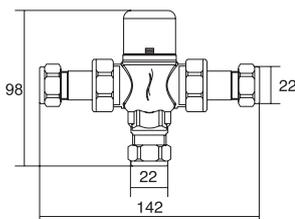

VALVE:
Thermostatic
INLET CONNECTIONS:
22mm Compression
WORKING PRESSURE:
0.2 – 5.0 bar

- Prevents scalding by accurately controlling the water temperature
- Approved at high and low pressure designations
- For single outlet



TBV010 Chrome

Ex.VAT £111.07 Inc.VAT £133.28

THERMOSTATIC 15MM BLENDING VALVE

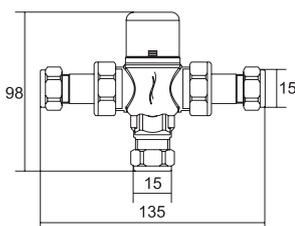

VALVE:
Thermostatic
INLET CONNECTIONS:
15mm Copper
WORKING PRESSURE:
0.2 – 5.0 bar

- Prevents scalding by accurately controlling the water temperature
- Approved at high and low pressure designations
- For single outlet



TBV008 Chrome

Ex.VAT £97.92 Inc.VAT £117.50



NEED IT TOMORROW?
NEXT DAY DELIVERY

ON ORDERS RECEIVED BEFORE 4PM*

*3pm on Fridays

DEVA COMMERCIAL SENSOR

SENSOR 3/D

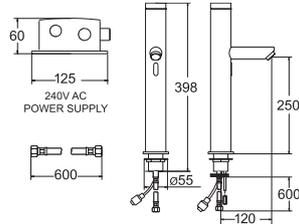

INLET CONNECTIONS:
½" BSP
WORKING PRESSURE:
0.5 – 5.0 bar

- Suitable for cold or premixed water
- Moisture and water resistant control unit
- Choice of battery or mains power
- Battery operation requires 4 x AA batteries
- Recommended for use with a blending valve see page 149



SENSOR3/D Chrome

Ex.VAT **£340.96** Inc.VAT **£409.15**

SENSOR 1/D

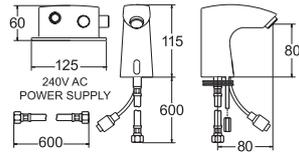

INLET CONNECTIONS:
½" BSP
WORKING PRESSURE:
0.5 – 5.0 bar

- Suitable for cold or premixed water
- Moisture and water resistant control unit
- Choice of battery or mains power
- Battery operation requires 4 x AA batteries
- Recommended for use with a blending valve see page 149



SENSOR1/D Chrome

Ex.VAT **£279.01** Inc.VAT **£334.81**

SENSOR 4/D

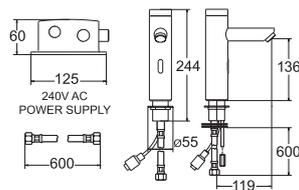

INLET CONNECTIONS:
½" BSP
WORKING PRESSURE:
0.5 – 5.0 bar

- Suitable for cold or premixed water
- Moisture and water resistant control unit
- Choice of battery or mains power
- Battery operation requires 4 x AA batteries
- Recommended for use with a blending valve see page 149



SENSOR4/D Chrome

Ex.VAT **£279.01** Inc.VAT **£334.81**

SENSOR 2/D

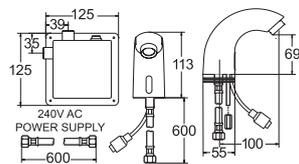

INLET CONNECTIONS:
½" BSP
WORKING PRESSURE:
0.5 – 5.0 bar

- Suitable for cold or premixed water
- Moisture and water resistant control unit
- Choice of battery or mains power
- Battery operation requires 4 x AA batteries
- Recommended for use with a blending valve see page 149



SENSOR2/D Chrome

Ex.VAT **£340.96** Inc.VAT **£409.15**

SENSOR 6/BT

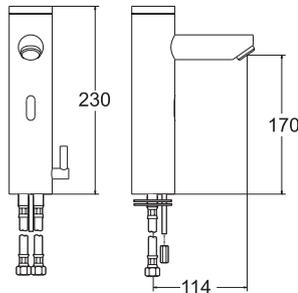

INLET CONNECTIONS:
1/2" BSP
WORKING PRESSURE:
0.5 – 5.0 bar

- Suitable for hot and cold water
- Moisture and water resistant control unit
- Battery operated, requires 4 x AA batteries
- Recommended for use with a blending valve see page 149



SENSOR6/BT Chrome

Ex.VAT **£279.01** Inc.VAT **£334.81**

SENSOR 7/D

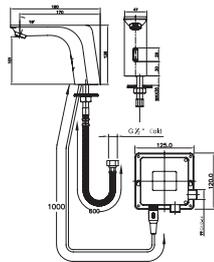

INLET CONNECTIONS:
1/2" BSP
WORKING PRESSURE:
0.5 – 5.0 bar

- Suitable for cold or premixed water
- Moisture and water resistant control unit
- Choice of battery or mains power
- Battery operation requires 4 x AA batteries
- Recommended for use with a blending valve see page 149



SENSOR7/D Chrome

Ex.VAT **£279.97** Inc.VAT **£335.96**

SENSOR 8/D

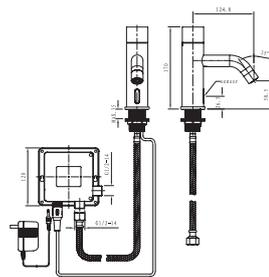

INLET CONNECTIONS:
1/2" BSP
WORKING PRESSURE:
0.5 – 5.0 bar

- Suitable for cold or premixed water
- Moisture and water resistant control unit
- Choice of battery or mains power
- Battery operation requires 4 x AA batteries
- Recommended for use with a blending valve see page 149



SENSOR8/D Chrome

Ex.VAT **£279.97** Inc.VAT **£335.96**

SENSOR 9/W

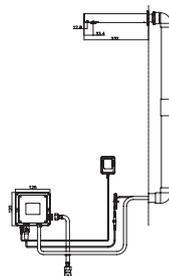

INLET CONNECTIONS:
1/2" BSP
WORKING PRESSURE:
0.5 – 5.0 bar

- Suitable for cold or premixed water
- Moisture and water resistant control unit
- Choice of battery or mains power
- Battery operation requires 4 x AA batteries
- Recommended for use with a blending valve see page 149



SENSOR9/W Chrome

Ex.VAT **£326.78** Inc.VAT **£392.14**

DEVA COMMERCIAL SENSOR

SENSOR 10/W

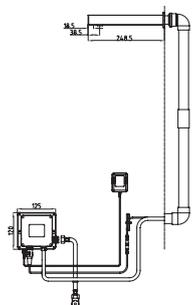

INLET CONNECTIONS:
1/2" BSP

WORKING PRESSURE:
0.5 – 5.0 bar



- Suitable for cold or premixed water
- Moisture and water resistant control unit
- Choice of battery or mains power
- Battery operation requires 4 x AA batteries
- Recommended for use with a blending valve see page 149

SENSOR10/W Chrome

Ex.VAT £326.78 Inc.VAT £392.14

SENSOR



SENSOR 7/D



SENSOR 8/D



SENSOR 9/W



SENSOR 10/W

- Suitable for cold or premixed water
- Moisture and water resistant control unit
- Automatically stops after 70 seconds maximum
- Working pressure 0.5 - 5.0 bar
- Choice of battery or mains power
- Battery operation requires 4 x AA batteries
- Recommended for use with a blending valve see page 149





ENVIRO-WISE SAVE WATER! LOOK OUT FOR THIS LOGO

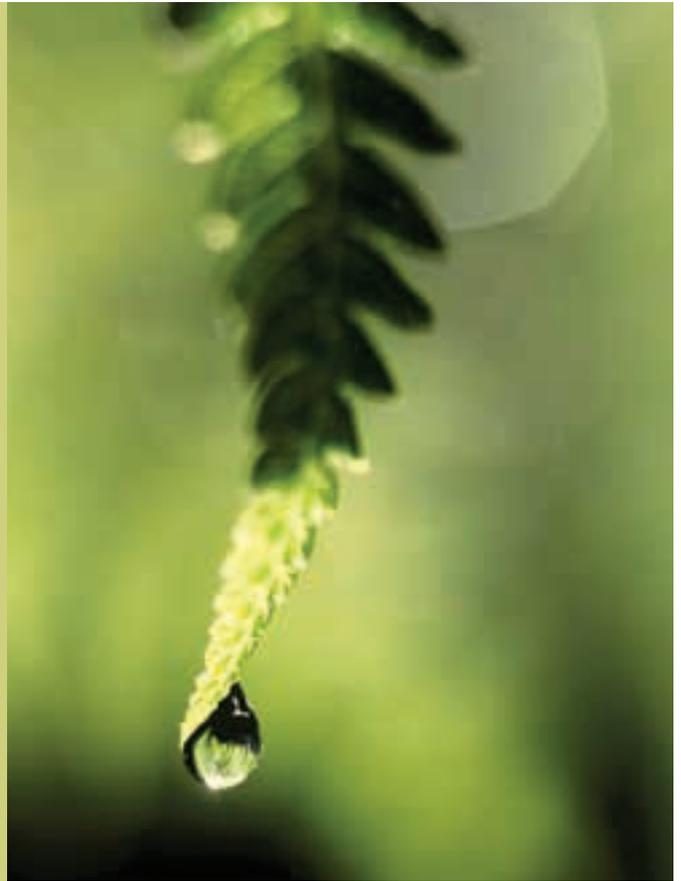

This logo identifies Deva's Enviro-wise™ products, all of which have been specifically designed to reduce water and energy usage.

ENVIRONMENTALLY BENEFICIAL HIGH PERFORMANCE

Here in the UK, we use an average of 150 litres of water per person every day. This usage is at an unsustainable level, and contributes to the increasing water stress experienced by regions of the UK and other parts of the world.

REDUCING WATER WASTAGE IS NOT AN OPTION – IT'S A NECESSITY.

There are some obvious steps we can all take to reduce our water usage; turn on taps and showers only when you are ready to use them and turn off the water whilst brushing your teeth. Fitting a flow regulator to taps and showers reduces water usage and can also help lower energy consumption by limiting the amount of water that's heated.

Water efficiency in building projects is more important than ever before due to updated Part G of the building regulations, which took effect in April 2010.

Look out for the Enviro-wise™ symbol, it indicates products which have been designed to enable you to save water and energy.

DEVA WASTES & SPARES

WASTES

1 1/4" BASIN SLOTTED WASTE

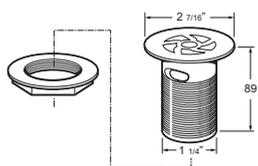

WSTGR114/S Chrome

Ex.VAT £9.01 Inc.VAT £10.81

1 1/4" BASIN UNSLOTTED WASTE

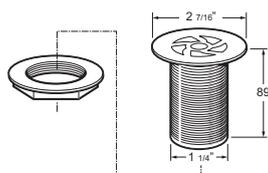

WSTGR114/UNS Chrome

Ex.VAT £9.54 Inc.VAT £11.45

1 1/4" BASIN FLIP TOP WASTE

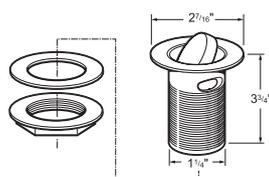

FTW300/017 Chrome

Ex.VAT £24.77 Inc.VAT £29.72

1 1/4" BASIN SLOTTED PRESS TOP WASTE

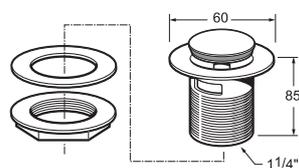

PTW300/017 Chrome

Ex.VAT £15.34 Inc.VAT £18.41



1 1/4" BASIN SLOTTED WASTE

- Complete With Poly Plug and Chain

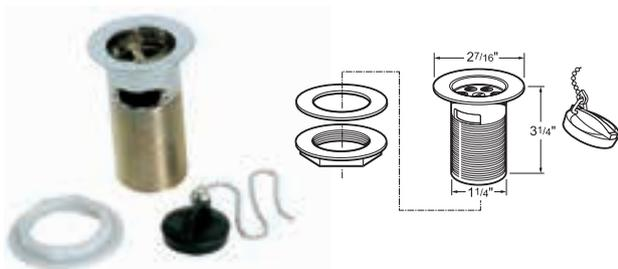

DW300 Chrome

Ex.VAT **£5.90** Inc.VAT **£7.08**

1 1/4" BASIN SLOTTED WASTE

- Complete With Brass Plug and Chain

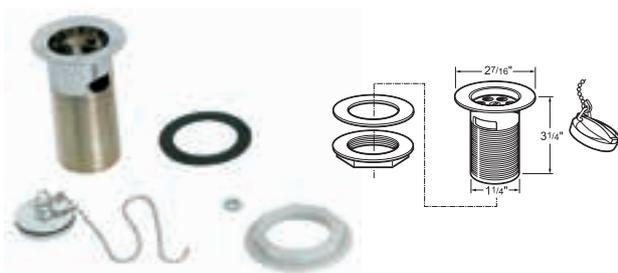

DW300/017 Chrome

Ex.VAT **£9.43** Inc.VAT **£11.32**

DW300/501 Gold

Ex.VAT **£34.28** Inc.VAT **£41.14**

1 1/4" PLASTIC BASIN WASTE



WST20/017 Chrome

Ex.VAT **£10.03** Inc.VAT **£12.04**

1 1/2" BATH FILL AND OVERFLOW WASTE

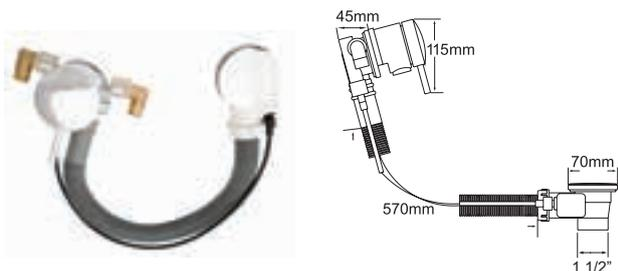

PUW206 Chrome

Ex.VAT **£111.49** Inc.VAT **£133.79**

DEVA WASTES & SPARES

WASTES

1 1/2" BATH TIDY WASTE

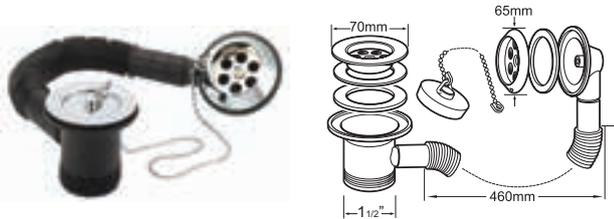

BTW404/017 Chrome

Ex.VAT £20.06 Inc.VAT £24.07

1 1/2" BATH PRESS TOP WASTE



PTW404/017 Chrome

Ex.VAT £29.50 Inc.VAT £35.40

1 1/2" BATH WASTE

- Pop up Waste

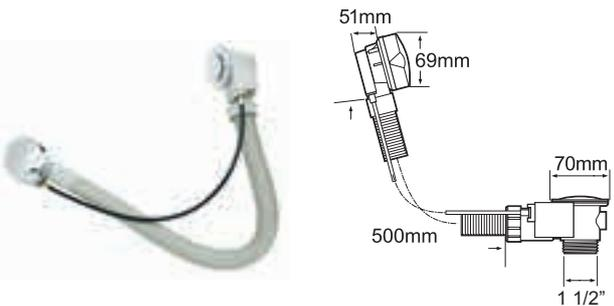

PUW200 Chrome

Ex.VAT £31.26 Inc.VAT £37.51

PUW200/501 Gold

Ex.VAT £56.94 Inc.VAT £68.33

1 1/2" BATH WASTE - PLASTIC BODY

- Complete With Overflow Assembly And Poly Plug



FOV414 Chrome

Ex.VAT £6.49 Inc.VAT £7.79

1 1/2" BATH CHROME PLATED EXPOSED WASTE AND OVERFLOW

- Chrome plated overflow tube
- Chain and plug

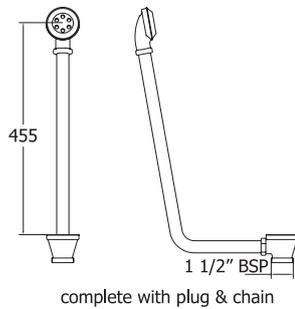

EBW404/017 Chrome

Ex.VAT **£61.94** Inc.VAT **£74.33**

1 1/2" BATH WASTE - BRASS BODY

- Complete With Overflow Assembly And Brass Plug

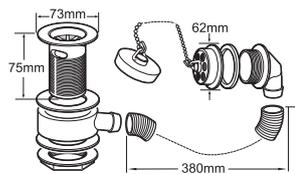

DW404/017 Chrome

Ex.VAT **£15.93** Inc.VAT **£19.12**

DW404/501 Gold

Ex.VAT **£41.02** Inc.VAT **£49.22**

1 1/4" BASIN, 1 1/2" BATH WASTE AND OVERFLOW SET

- 1 1/4" Basin Waste
- 1 1/2" Plastic Bath Waste And Overflow

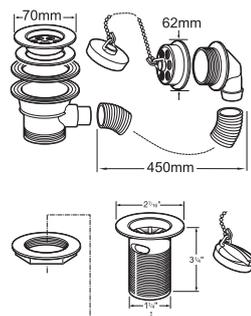

WST27/017 Chrome

Ex.VAT **£15.93** Inc.VAT **£19.12**

WST27/501 Gold

Ex.VAT **£41.02** Inc.VAT **£49.22**

1 1/2" BATH WASTE AND OVERFLOW

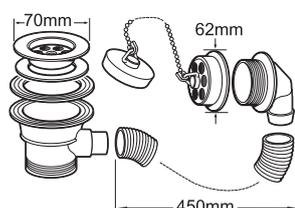

WST27/BATH Chrome

Ex.VAT **£13.57** Inc.VAT **£16.28**

DEVA WASTES & SPARES

WASTES

1 1/2" BATH UNSLOTTED WASTE

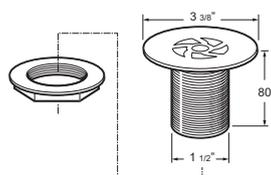

WSTGR112/UNS Chrome

Ex.VAT £13.78 Inc.VAT £16.54

1 1/2" SINK WASTE WITH OVERFLOW

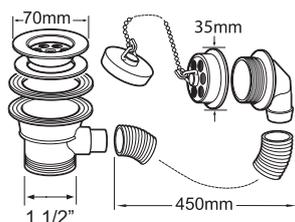

FOV412 Chrome

Ex.VAT £7.08 Inc.VAT £8.50

1 1/4" BOTTLE TRAP WITH WALL EXTENSION

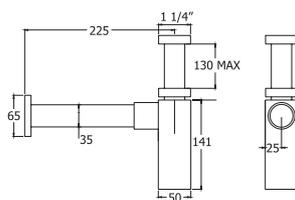

VSN625 Chrome

Ex.VAT £50.00 Inc.VAT £60.00

1 1/4" BOTTLE TRAP WITH WALL EXTENSION

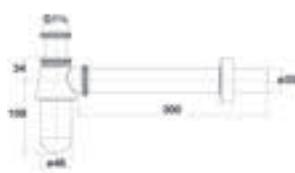

TCP625 Chrome

Ex.VAT £37.16 Inc.VAT £44.59

TCP625/501 Gold

Ex.VAT £63.05 Inc.VAT £75.66



SQUARE BOTTLE TRAP WITH WALL EXTENSION

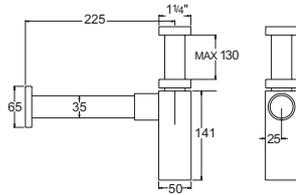

TCP626 Chrome

Ex. VAT **£60.00** Inc. VAT **£72.00**

DEVA WASTES & SPARES

SHOWER SPARES

CONCEALED SHOWER SPINDLE EXTENSION

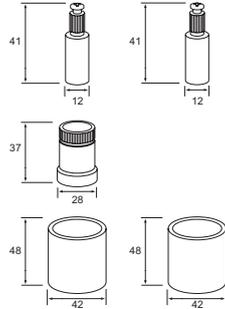

INLET CONNECTIONS:
1/2" BSP
WORKING PRESSURE:
0.35 – 5.0 bar



XTSPIND Chrome

Ex.VAT **£84.80** Inc.VAT **£101.76**

EXPOSED ELBOWS FOR BAR SHOWERS

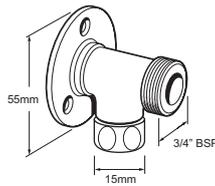

INLET CONNECTIONS:
15mm Compression

• Sold in pairs

SPE04 Chrome

Ex.VAT **£37.76** Inc.VAT **£45.31**

WALL BRACKET

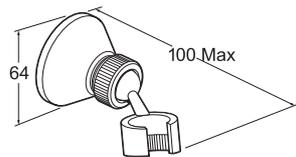

SPE05 Chrome

Ex.VAT **£8.85** Inc.VAT **£10.62**

SPE05/G Gold

Ex.VAT **£21.43** Inc.VAT **£25.72**

WALL BRACKET – CHROME

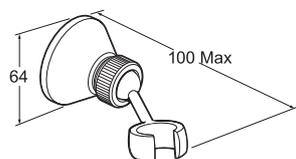

SPE06 Chrome

Ex.VAT **£18.29** Inc.VAT **£21.95**



HOSE RETAINER

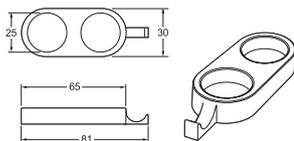

SPE08 Chrome

Ex.VAT **£4.13** Inc.VAT **£4.96**

HOSE RETAINER WALL MOUNTED

- Brass construction

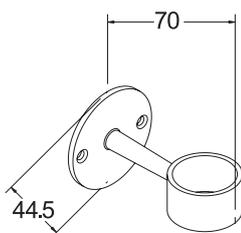

SPE09 Chrome

Ex.VAT **£11.20** Inc.VAT **£13.44**

BRASS STRAIGHT NIPPLE AND BACK NUT 1/2"

INLET CONNECTIONS:
1/2" BSP

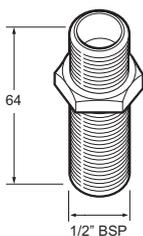

SPE13 Brass

Ex.VAT **£8.26** Inc.VAT **£9.91**



NEED IT TOMORROW?

**NEXT DAY
DELIVERY**

ON ORDERS RECEIVED BEFORE 4PM*

*3pm on Fridays

DEVA WASTES & SPARES

TAP SPARES

STR3AM REPLACEMENT FILTER

- Carbon Polyphosphate Filter



FILTER 001 White

Ex.VAT **£24.19** Inc.VAT **£29.03**

80MM WALL EXTENSIONS

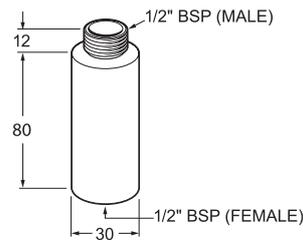

INLET CONNECTIONS:
1/2" BSP

- Sold in singles
- For use with bib taps

095 80MM Chrome

Ex.VAT **£37.16** Inc.VAT **£44.59**

WALL EXTENSIONS

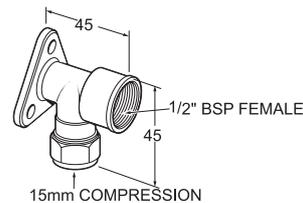

INLET CONNECTIONS:
15mm Compression

- Sold in pairs
- For use with bib taps

095 WALL EXT Chrome

Ex.VAT **£74.33** Inc.VAT **£89.20**

ADJUSTABLE BATH PIPE SHROUDS

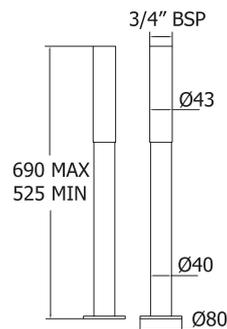

INLET CONNECTIONS:
3/4" BSP

- Height adjustable
- Sold in pairs

RLE04S Chrome

Ex.VAT **£185.82** Inc.VAT **£222.98**



VALVE TO SUIT DLT RANGE 1/2"

- Sold in pairs – dispatched as 1 hot and 1 cold valve



CDV001 Brass

Ex.VAT **£21.83** Inc.VAT **£26.20**

STANDARD DEVA VALVE 1/2"

- Sold in pairs – dispatched as 1 hot and 1 cold valve



V2 Brass

Ex.VAT **£9.43** Inc.VAT **£11.32**

CHROME PLATED HANDLE OPTION



DCM179 Chrome

Ex.VAT **£7.67** Inc.VAT **£9.20**

PROFILE ACRYLIC TAP HEAD



DAC179 Acrylic

Ex.VAT **£5.90** Inc.VAT **£7.08**

DEVA WASTES & SPARES

TAP SPARES

PERIOD STYLE CONVERSION KIT BS5412 ONLY

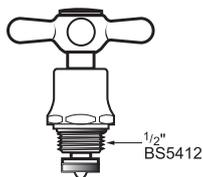

WORKING PRESSURE:
0.1 – 5.0 bar

- Sold in pairs – suitable to replace most basin, sink and bath taps, either BS5412 or BS1010

VIC CONV.KIT Chrome Ex.VAT £32.45 Inc.VAT £38.94

VIC CONV.KIT/501 Gold Ex.VAT £58.16 Inc.VAT £69.79

3" LEVER CONVERSION KIT BS5412/BS1010

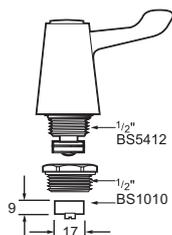

WORKING PRESSURE:
0.1 – 5.0 bar

- Sold in pairs – suitable to replace most basin, sink and bath taps, either BS5412 or BS1010



DFVKIT Chrome Ex.VAT £41.30 Inc.VAT £49.56

UNIVERSAL CONVERSION KIT

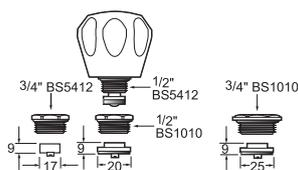

WORKING PRESSURE:
0.1 – 5.0 bar

- Sold in pairs – suitable to replace most basin, sink and bath taps, either BS5412 or BS1010

MCK001 Chrome Ex.VAT £21.23 Inc.VAT £25.48

UNIVERSAL CONVERSION KIT – ACRYLIC HANDLE

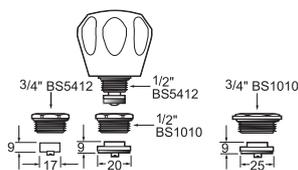

WORKING PRESSURE:
0.1 – 5.0 bar

- Sold in pairs – suitable to replace most basin, sink and bath taps, either BS5412 or BS1010



ACK001 Acrylic Ex.VAT £20.65 Inc.VAT £24.78

INDEX OF PRODUCTS

Code	Description	Ex.VAT	Inc.VAT	Page	Code	Description	Ex.VAT	Inc.VAT	Page
095 80MM	80mm Wall Extensions - Chrome	£37.16	£44.59	162	DAC179	Profile Acrylic Tap Head - Acrylic	£5.90	£7.08	163
095 WALL EXT	Wall Extensions - Chrome	£74.33	£89.20	162	DCM SPEC101	Profile Basin Taps - Chrome	£26.37	£30.44	142
095X	Cross Handle 1/2" BS5412 Valve Bib Taps - Chrome	£29.50	£35.40	140	DCM SPEC102	Profile Bath Taps - Chrome	£27.14	£32.57	143
181X	Cross Handle Basin Taps - Chrome	£29.50	£35.40	140	DCM SPEC103	Profile Sink Taps - Chrome	£31.85	£38.22	144
182X	Cross Handle Bath Taps - Chrome	£31.26	£37.51	140	DCM SPEC105	Profile Deck Mounted Sink Mixer - Chrome	£58.99	£70.79	144
183X	Cross Handle Sink Taps - Chrome	£32.45	£38.94	141	DCM101	Profile Basin Taps - Chrome	£22.42	£26.90	142
186X	Cross Handle Deck Mounted Bath Shower Mixer - Chrome	£117.98	£141.58	140	DCM101/501	Profile Basin Taps - Gold	£47.75	£57.30	142
187X	Cross Handle Deck Mounted Sink Mixer - Chrome	£56.04	£67.25	141	DCM102	Profile Bath Taps - Chrome	£24.19	£29.03	143
ACK001	Universal Conversion Kit - Acrylic Handle	£20.65	£24.78	164	DCM102/501	Profile Bath Taps - Gold	£49.59	£59.51	143
ADOCMANM01	Adore Manual Shower Valve With Single Mode Kit - Chrome	£161.61	£193.93	76	DCM103	Profile Sink Taps - Chrome	£28.91	£34.69	144
ADORE101	Adore Basin Taps - Chrome	£51.43	£61.72	112	DCM104	Profile Mono Sink Mixer - Chrome	£65.48	£78.58	144
ADORE101/501	Adore Basin Taps - Gold	£81.62	£97.94	112	DCM105	Profile Deck Mounted Sink Mixer - Chrome	£56.04	£67.25	144
ADORE102	Adore Bath Taps - Chrome	£64.27	£77.12	113	DCM106	Profile Deck Mounted Bath Shower Mixer - Chrome	£90.84	£109.01	143
ADORE102/501	Adore Bath Taps - Gold	£88.77	£106.52	113	DCM106/501	Profile Deck Mounted Bath Shower Mixer - Gold	£155.49	£186.59	143
ADORE106	Adore Deck Mounted Bath Shower Mixer - Chrome	£122.43	£146.92	113	DCM108	Profile Deck Mounted Bath Filler - Chrome	£71.96	£86.35	143
ADORE106/501	Adore Deck Mounted Bath Shower Mixer - Gold	£183.65	£220.38	113	DCM108/501	Profile Deck Mounted Bath Filler - Gold	£123.65	£148.38	143
ADORE108	Adore Deck Mounted Bath Filler - Chrome	£102.84	£123.41	113	DCM113	Profile Mono Basin Mixer With Pop Up Waste - Chrome	£60.76	£72.91	142
ADORE108/501	Adore Deck Mounted Bath Filler - Gold	£151.81	£182.17	113	DCM113/501	Profile Mono Basin Mixer With Pop Up Waste - Gold	£99.78	£119.74	142
ADORE113	Adore Mono Basin Mixer - Chrome	£71.01	£85.21	112	DCM113B	Profile Mono Basin Mixer - Chrome	£56.04	£67.25	142
ADORE113/501	Adore Mono Basin Mixer - Gold	£107.73	£129.28	112	DCM179	Chrome Plated Handle Option - Chrome	£7.67	£9.20	163
ADORE113/EK	Adore Mono Basin Mixer - Chrome	£71.01	£85.21	112	DCP124/004	Profile Mono Sink Mixer - Beige	£86.72	£104.06	144
ADORE171	Adore Mono Sink Mixer - Chrome	£96.72	£116.06	125	DCP124/005	Profile Mono Sink Mixer - White	£86.72	£104.06	144
ADORE171/EK	Adore Mono Sink Mixer - Chrome	£96.72	£116.06	125	DCTSDEF	Dynamic Cool To Touch Bar Shower With Diverter to Fixed Head & Handset - Chrome	£326.78	£392.14	67
ADORE313	Adore Mini Mono Basin Mixer - Chrome	£51.43	£61.72	112	DFV095	Lever Action Bib Taps - Chrome	£61.94	£74.33	134
ADORE313W	Adore Mini Mono Basin Mixer - Chrome	£64.63	£77.56	112	DFVKIT	3" Lever Conversion Kit BS5412/BS1010 - Chrome	£41.30	£49.56	164
AOBBCPUK	Aio Basin Mixer - Chrome	£173.23	£207.88	50	DLT SPEC101	Lever Action Basin Taps - Chrome	£38.34	£46.01	135
AOBFCPUK	Aio Bath Filler - Chrome	£234.08	£280.90	50	DLT SPEC102	Lever Action Bath Taps - Chrome	£41.88	£50.26	135
AOBMCPUK	Aio Mini Basin Mixer - Chrome	£149.81	£179.77	50	DLT SPEC103	Lever Action Sink Taps - Chrome	£41.88	£50.26	136
AOBSMCPUK	Aio Bath Shower Mixer - Chrome	£279.97	£335.96	50	DLT SPEC105	Lever Action Deck Mounted Sink Mixer - Chrome	£76.10	£91.32	137
AOBSMCPWHUK	Aio Bath Shower Mixer - Chrome & White	£279.97	£335.96	50	DLT SPEC106	Lever Action Deck Mounted Bath Shower Mixer - Chrome	£123.29	£147.95	136
AOCTSCPUK	Aio Cool To Touch Bar Mixer Shower Kit - Chrome	£279.97	£335.96	23	DLT TSM 106	Thermostatic Bath Shower Mixer - Chrome	£684.87	£821.84	148
AOCTSCPWHUK	Aio Cool To Touch Bar Mixer Shower Kit - Chrome & White	£279.97	£335.96	23	DLT095	Lever Action Bib Taps - Chrome	£57.63	£69.16	134
AOHRCPUK	Aio Hi Rise Shower - Chrome	£219.10	£262.92	22	DLT101	Lever Action Basin Taps - Chrome	£35.39	£42.47	135
AOHRCPWHUK	Aio Hi Rise Shower - Chrome & White	£219.10	£262.92	22	DLT102	Lever Action Bath Taps - Chrome	£38.93	£46.72	135
AOHSCPUK	Aio Handset - Chrome	£83.34	£100.01	21	DLT103	Lever Action Sink Taps - Chrome	£38.93	£46.72	136
AOHSCPWHUK	Aio Handset - Chrome & White	£83.34	£100.01	21	DLT104	Lever Action Mono Sink Mixer - Chrome	£97.92	£117.50	137
AOOSCPUK	Aio Overhead Shower - Chrome	£233.15	£279.78	20	DLT105	Lever Action Deck Mounted Sink Mixer - Chrome	£73.15	£87.78	137
AOOSCPWHUK	Aio Overhead Shower - Chrome & White	£233.15	£279.78	20	DLT106	Lever Action Deck Mounted Bath Shower Mixer - Chrome	£120.34	£144.41	136
AOSACPUK	Aio Wall Shower On Short Arm - Chrome	£144.19	£173.03	21	DLT108	Lever Action Deck mounted Bath Filler - Chrome	£99.10	£118.92	136
AOSACPWHUK	Aio Wall Shower On Short Arm - Chrome & White	£144.19	£173.03	21	DLT113	Lever Action Mono Basin Mixer With Pop Up Waste - Chrome	£85.53	£102.64	134
AOSRCPUK	Aio Rail Shower - Chrome	£186.33	£223.60	23	DLT305B	Lever Action 3" Lever Bridge Sink Mixer - With Adjustable Centres - Chrome	£140.40	£168.48	137
AOSRCPWHUK	Aio Rail Shower - Chrome & White	£186.33	£223.60	23	DLTKIT	Lever Action 3" Conversion Kit - Chrome	£41.94	£50.33	138
AOSSCPUK	Aio Shower System - Chrome	£560.87	£673.04	20	DLV002	Lever Action 6" Lever handle Option	£36.00	£43.20	134
AOSSCPWHUK	Aio Shower System - Chrome & White	£560.87	£673.04	20	DLV101	Lever Action Basin Taps - Chrome 6"	£72.56	£87.07	135
AOWOBCPUK	Aio Hand Shower - Chrome	£159.18	£191.02	22	DLV102	Lever Action Bath Taps - Chrome 6"	£76.10	£91.32	135
AOWOBCPWHUK	Aio Hand Shower - Chrome & White	£159.18	£191.02	22	DLV103	Lever Action Sink Taps - Chrome 6"	£76.10	£91.32	136
ARMCO3	Round Ceiling Shower Arm 20cm - Chrome	£37.76	£45.31	83	DLV105	Lever Action Deck Mounted Sink Mixer - Chrome 6"	£111.49	£133.79	137
ARMCO4	Square Ceiling Shower Arm 20cm - Chrome	£43.65	£52.38	84	DLV305B	Lever Action 6" Lever Bridge Sink Mixer With Adjustable Centres - Chrome	£185.82	£222.98	138
ARMW01	Brass Shower Arm - Chrome	£23.00	£27.60	84	DLV305WM	Lever Wall Mounted Bridge Sink Mixer 6" Levers - Chrome	£192.31	£230.77	138
ARMW01/G	Brass Shower Arm - Gold	£48.37	£58.04	84	DW300	1 1/2" Basin Slotted Waste - Chrome	£5.90	£7.08	155
ARMW02	Shower Arm - Chrome	£26.54	£31.85	84	DW300/017	1 1/4" Basin Slotted Waste - Chrome	£9.43	£11.32	155
ARMW05	Square Shower Arm - Chrome	£50.14	£60.17	84	DW300/501	1 1/2" Basin Slotted Waste - Gold	£34.28	£41.14	155
AVSH001	Anti-Vandal Shower Head - Chrome	£74.33	£89.20	147	DW404/017	1 1/2" Bath Waste - Brass Body - Chrome	£15.93	£19.12	157
BRBCPUK	Breeze Basin Mixer - Chrome	£120.79	£144.95	58	DW404/501	1 1/2" Bath Waste - Brass Body - Gold	£41.02	£49.22	157
BRBFCPUK	Breeze Bath Filler - Chrome	£176.97	£212.36	58	DYN 106	Dynamic Pillar Mounted Thermostatic Bath Shower Mixer - Chrome	£247.75	£297.30	148
BRBSMCPUK	Breeze Bath Shower Mixer - Chrome	£205.06	£246.07	58	EBW404/017	1 1/2" Bath Chrome Plated Exposed Waste And Overflow - Chrome	£61.94	£74.33	157
BTW404/017	1 1/2" Bath Tidy Waste - Chrome	£20.06	£24.07	156	EDGE104	Edge Mono Sink Mixer - Chrome	£167.53	£201.04	122
CABCPUK	Cari Basin Mixer - Chrome	£120.79	£144.95	60	EDGE118	Edge Mono Sink Mixer - Chrome	£210.59	£252.71	122
CABFCPUK	Cari Bath Filler - Chrome	£176.97	£212.36	60	EDGERAIL705	Edge Shower Rail - Chrome	£93.63	£112.36	46
CABSMCPUK	Cari Bath Shower Mixer - Chrome	£205.06	£246.07	60	EKIT01/A	Airstream 3 Mode Easy Fit Shower Kit - Chrome/White	£82.02	£98.42	45
CDV001	Valve To Suit DLT Range 1/2" - Brass	£21.83	£26.20	163	EKIT02/A	Airstream 3 Mode Easy Fit Shower Kit - Chrome	£73.18	£87.82	45
CMS191	Profile Contract Mono Sink Mixer - Chrome	£65.48	£78.58	145	EKIT03/A	Airstream 3 Mode Easy Fit Shower Kit - Chrome	£73.18	£87.82	46
CMS191/002	Profile Contract Mono Sink Mixer - Mocha	£86.72	£104.06	145	ELAN101	Elan Basin Taps - Chrome	£74.33	£89.20	104
CNTL01	Lever Action Basin Taps - Chrome	£38.93	£46.72	139	ELAN102	Elan Bath Taps - Chrome	£86.72	£104.06	104
CNTL02	Lever Action Bath Taps - Chrome	£44.83	£53.80	139	ELAN106/DM	Elan Deck Mounted Bath Shower Mixer - Chrome	£147.48	£176.98	105
CNTL03	Lever Action Contract Sink Pillar Taps - Chrome	£44.83	£53.80	139	ELAN108	Elan Deck Mounted Bath Filler - Chrome	£117.98	£141.58	105
COMBMEF	Combi Bar Shower With Multi Mode Kit - Chrome	£168.12	£201.74	64	ELAN113	Elan Mono Basin Mixer - Chrome	£105.59	£126.71	104
COMBS	Combi Bar Shower With Single Mode Kit - Chrome	£111.43	£133.72	67	ELAN313	Elan Mini Mono Basin Mixer - Chrome	£87.90	£105.48	104
CONV130	Converse Mono Sink Mixer - Chrome	£117.98	£141.58	124	ELAN313W	Elan Mini Mono Basin Mixer - Chrome	£100.62	£120.74	104
CORM03	Non Concussive Self Closing Pillar Basin Tap - Chrome	£31.26	£37.51	146	EPR104	Expression Mono Sink Mixer - Chrome	£192.31	£230.77	123
CR19	Coronation Basin Taps - Chrome	£74.33	£89.20	116	FILTER 001	Str3Am Replacement Filter - White	£24.19	£29.03	162
CR19/501	Coronation Basin Taps - Gold	£101.62	£121.94	116	FILTER 001	Str3Am Mono Water Filter - White	£24.19	£29.03	121
CR20	Coronation Bath Taps - Chrome	£93.21	£111.85	116	FLU115	Flugel Mono Sink Mixer - Chrome	£222.98	£267.58	121
CR20/501	Coronation Bath Taps - Gold	£121.21	£145.45	116	FOV412	1 1/2" Sink Waste With Overflow - Chrome	£7.08	£8.50	158
CR21	Coronation Cloakroom Taps - Chrome	£71.96	£86.35	116	FOV414	1 1/2" Bath Waste - Plastic Body - Chrome	£6.49	£7.79	156
CR21/501	Coronation Cloakroom Taps - Gold	£99.17	£119.00	116	FR SP113-1.7	Flow Regulator - For Mono Basin And Sink Mixers - 1.7 L/min	£4.72	£5.66	93
CR23	Coronation Pillar Mounted Bath Shower Mixer - Chrome	£309.69	£371.63	117	FR SP113-5	Flow Regulator - For Mono Basin And Sink Mixers - 5 L/min	£4.72	£5.66	93
CR23/501	Coronation Pillar Mounted Bath Shower Mixer - Gold	£382.59	£459.11	117	FR101-2	Flow Regulator - For Mono Basin And Sink Mixers - 2 L/min	£4.72	£5.66	93
CR24	Coronation Mono Basin Mixer With Pop Up Waste - Chrome	£155.14	£186.17	116	FR101-3	Flow Regulator - For Mono Basin And Sink Mixers - 3 L/min	£4.72	£5.66	93
CR24/501	Coronation Mono Basin Mixer With Pop Up Waste - Gold	£197.73	£237.28	116	FR101-4	Flow Regulator - For Mono Basin And Sink Mixers - 4 L/min	£4.72	£5.66	93
CR25	Coronation Bidet Mixer With Pop Up Waste - Chrome	£173.43	£208.12	117	FR101-6	Flow Regulator - For Mono Basin And Sink Mixers - 6 L/min	£4.72	£5.66	93
CR25/501	Coronation Bidet Mixer With Pop Up Waste - Gold	£216.70	£260.04	117	FR106-12	Flow Regulator - 12 L/min For showers above 1 bar	£4.72	£5.66	85
CR26	Coronation Bath Filler - Chrome	£235.36	£282.43	117	FR106-12	Flow Regulator - For Bath Shower Mixers above 1.0 bar	£4.72	£5.66	93
CR26/501	Coronation Bath Filler - Gold	£293.22	£351.86	117	FR106-4	Outlet Regulator - For Bath Shower Mixers above 1.0 bar	£7.66	£9.19	93
CR27A	Coronation High Neck Sink Taps - Chrome	£85.53	£102.64	129	FR106-7	Flow Regulator - 7 L/min For showers above 1 bar	£7.66	£9.19	85
CR27A/501	Coronation High Neck Sink Taps - Gold	£113.25	£135.90	129					
CR305	Coronation Bridge Sink Mixer - Chrome	£205.87	£247.04	128					
CR305/501	Coronation Bridge Sink Mixer - Gold	£250.37	£300.44	128					
CRUX106	Crux Deck Mounted Bath Shower Mixer - Chrome	£222.98	£267.58	100					
CRUX108	Crux Deck Mounted Bath Filler - Chrome	£173.43	£208.12	100					
CRUX120	Crux Mono Basin Mixer - Chrome	£148.65	£178.38	100					

INDEX OF PRODUCTS

Code	Description	Ex.VAT	Inc.VAT	Page	Code	Description	Ex.VAT	Inc.VAT	Page
FR106-7	Flow Regulator - For Bath Shower Mixers above 1.0 bar	£7.66	£9.19	93	KIRI 1V	Kiri Concealed Mixer Valve(Single Outlet) - Chrome (Brass)	£279.97	£335.96	35
FR113-4	Flow Regulator For Mono Basin And Mono Sink Mixers - 4 L/min	£4.72	£5.66	93	KIRI 1VA	Kiri Concealed Mixer Valve(Single Outlet) - Chrome (ABS plate)	£235.80	£282.96	35
FR113-5	Flow Regulator For Mono Basin And Mono Sink Mixers - 5 L/min	£4.72	£5.66	93	KIRI 2VDIV	Kiri Concealed Mixer Valve (2 outlets) - Chrome (Brass)	£326.78	£392.14	35
FRV 9	Flow Regulator (for AVSH001)	£2.95	£3.54	85	KIRI 2VDIVA	Kiri Concealed Mixer Valve (2 outlets) - Chrome (ABS plate)	£282.61	£339.13	35
FTW300/017	1½" Basin Flip Top Waste - Chrome	£24.77	£29.72	154	KIRI 3VDIV	Kiri Concealed Mixer Valve (3 Outlets) - Chrome (Brass)	£420.42	£504.50	36
GE01	Georgian Basin Taps - Chrome	£93.21	£111.85	114	KIRI 3VDIVA	Kiri Concealed Mixer Valve (3 Outlets) - Chrome (ABS plate)	£376.25	£451.50	36
GE01/501	Georgian Basin Taps - Gold	£121.21	£145.45	114	KIRI SPDIV	Kiri Shower Pole with Diverter from Fixed Head to Handset - Chrome & Graphite	£607.68	£729.22	36
GE02	Georgian Bath Taps - Chrome	£111.49	£133.79	114	KISP172CPUK	Kiri Bath Wall Spout - Chrome	£102.06	£122.47	53
GE02/501	Georgian Bath Taps - Gold	£140.18	£168.22	114	KISSMCP	Kiri Sequential Valve & Kit - Chrome & Graphite	£214.42	£257.30	38
GE03	Georgian Pillar Mounted Bath Shower Mixer - Chrome	£408.79	£490.55	115	KITM03	5 Mode Shower Kit - Chrome	£56.04	£67.25	78
GE03/501	Georgian Pillar Mounted Bath Shower Mixer - Gold	£485.43	£582.52	115	KITS02	Square Shower Kit - Chrome	£74.92	£89.90	79
GE04	Georgian Mono Basin Mixer With Pop Up Waste - Chrome	£185.82	£222.98	114	KITS06	Period Style Shower Kit - Chrome	£124.47	£149.36	79
GE04/501	Georgian Mono Basin Mixer With Pop Up Waste - Gold	£229.56	£275.47	114	KITS06/G	Period Style Shower Kit - Gold	£153.66	£184.39	79
GE06	Georgian Bidet Mixer With Pop Up Waste - Chrome	£136.26	£163.51	114	KITS08	Period Style Rigid Riser Shower Kit - Chrome	£155.74	£186.89	81
GE06/501	Georgian Bidet Mixer With Pop Up Waste - Gold	£178.13	£213.76	114	KITS08/G	Period Style Rigid Riser Shower Kit - Gold	£186.10	£223.32	81
GE08	Georgian Pillar Mounted Bath Filler - Chrome	£284.92	£341.90	115	KITS09	Minimalist Rigid Riser Kit With Diverter To Fixed Head and Handset - Chrome	£223.56	£268.27	81
GE08/501	Georgian Pillar Mounted Bath Filler - Gold	£344.64	£413.57	115	KK1	Kiri Shower Kit - Chrome & Graphite	£55.25	£66.30	33
GE0305	Georgian Bridge Sink Mixer - Chrome	£204.70	£245.64	128	KLTCPUK	Kiri Lever Pillar Taps - Chrome	£84.80	£101.76	55
GE0CCONT05	Georgian Concentric Shower With Single Mode Kit - Chrome	£471.91	£566.29	72	KLTV106	Kiri Lever Thermostatic Pillar Mounted Bath Shower Mixer - Chrome	£296.80	£356.16	53
GE0CRR	Georgian Traditional Exposed Concentric Shower With Rigid Riser & Rose - Chrome	£506.71	£608.05	72	KLTV106/2BK	Kiri Lever Thermostatic Pillar Mounted Bath Shower Mixer - Chrome	£345.56	£414.67	54
HANM04	5 Mode Handset - Chrome	£25.37	£30.44	86	KMKIT	Krome & Krome With Air 3 Mode Shower Kit - Chrome	£83.56	£100.27	80
HANM09	Krome 3 Mode Handset 100mm - Chrome	£24.57	£29.48	87	KMKIT/A	Krome & Krome With Air 3 Mode Shower Kit - Chrome	£86.52	£103.82	80
HANS02	Victorian Single Mode Handset - Chrome	£31.26	£37.51	86	KOHPCPUK	Kaha Handset - Chrome & Graphite	£65.54	£78.65	26
HANS02/G	Victorian Single Mode Handset - Gold	£56.94	£68.33	86	KOHPCPWUK	Kaha Handset - Chrome & White	£65.54	£78.65	26
HANS03	Traditional Single Mode Handset - Chrome	£33.62	£40.34	86	KOWSCPUK	Kaha Shower Head - Chrome & Graphite	£70.23	£84.28	26
HANS03/G	Traditional Single Mode Handset - Gold	£59.39	£71.27	86	KSR004	Kiri Shower Rail - Chrome	£74.91	£89.89	47
HANS08	Krome Single Mode Handset 100mm - Chrome	£19.16	£22.99	86	LACCMANM02	Lace Manual Shower Valve With Single Mode Kit - Chrome	£161.61	£193.93	76
HEA05	Single Mode Shower Head With Arm - Chrome	£58.30	£69.96	83	LACE101	Lace Basin Taps - Chrome	£51.43	£61.72	110
HEA06	3 Mode Shower Head With Arm - Chrome	£62.53	£75.04	83	LACE102	Lace Bath Taps - Chrome	£64.27	£77.12	111
HEA01	2" (50mm) Brass Shower Head With Swivel Joint - Chrome	£19.46	£23.35	82	LACE106	Lace Deck Mounted Bath Shower Mixer - Chrome	£122.43	£146.92	111
HEA02	5" (125mm) Traditional Shower Head With Swivel Joint - Chrome	£49.16	£58.99	82	LACE108	Lace Deck Mounted Bath Filler - Chrome	£102.84	£123.41	111
HEA02/G	5" (125mm) Traditional Shower Head With Swivel Joint - Gold	£76.54	£91.85	82	LACE113	Lace Mono Basin Mixer - Chrome	£71.01	£85.21	110
HEA04	8" (200mm) Square Shower Head With Swivel Joint - Chrome	£54.07	£64.88	83	LACE113/EK	Lace Mono Basin Mixer - Chrome	£71.01	£85.21	110
HEA05	8" (200mm) Round Fixed Head With Swivel Joint - Chrome	£39.33	£47.20	82	LACE114	Lace Bidet Mixer - Chrome	£102.84	£123.41	110
HEA06	Krome 8" (200mm) Fixed Head With Swivel Joint - Chrome	£44.24	£53.09	82	LACE115	Lace Single Lever Sink Mixer With Pull Out Rinser - Chrome	£199.56	£239.47	123
HOS1.5CP01	Standard Bore Chrome Hoses - Chrome	£11.80	£14.16	87	LACE171	Lace Mono Sink Mixer - Chrome	£96.72	£116.06	125
HOS1.5CP01/G	Large Bore Chrome Hoses - Gold	£35.72	£42.86	87	LACE313	Lace Mini Mono Basin Mixer - Chrome	£51.43	£61.72	110
HOS1.5CPW04	Large Bore Chrome Hoses - Chrome	£18.88	£22.66	87	LACE313W	Lace Mini Mono Basin Mixer - Chrome	£64.63	£77.56	110
HOS1.5CPW04/G	Large Bore Chrome Hoses - Gold	£40.81	£48.97	87	LACVMANM03	Lace Manual Shower Valve - Chrome	£116.31	£139.57	77
HOS1.5PV07	Smooth Shower Hose 1.5m - Chrome	£25.37	£30.44	49	LACVMANM03/G	Lace Manual Shower Valve - Gold	£140.79	£168.95	77
HOS1.75CP02	Large Bore Chrome Hoses - Chrome	£20.06	£24.07	87	LEV104	Lever Mono Sink Mixer - Chrome	£68.42	£82.10	126
HOS2.0CP03	Large Bore Chrome Hoses - Chrome	£22.42	£26.90	87	LINX106	Linx Deck Mounted Bath Shower Mixer - Chrome	£222.98	£267.58	98
HOS2.0CPW06	Large Bore Chrome Hoses - Chrome	£23.60	£28.32	87	LINX108	Linx Deck Mounted Bath Filler - Chrome	£173.43	£208.12	99
HSR 2	Seal Flow Regulator - 2 L/min Replaces standard seal	£2.95	£3.54	85	LINX113	Linx Mono Basin Mixer - Chrome	£148.65	£178.38	98
HSR 3	Seal Flow Regulator - 3 L/min Replaces standard seal	£2.95	£3.54	85	LINX120	Linx Mono Basin Mixer - Chrome	£148.65	£178.38	98
HSR 4	Seal Flow Regulator - 4 L/min Replaces standard seal	£2.95	£3.54	85	LINX313	Linx Mini Mono Basin Mixer - Chrome	£123.88	£148.66	98
HSR 6	Seal Flow Regulator - 6 L/min Replaces standard seal	£2.95	£3.54	85	LINX313W	Linx Mini Mono Basin Mixer - Chrome	£136.60	£163.92	98
HSR 8	Seal Flow Regulator - 8 L/min Replaces standard seal	£2.95	£3.54	85	MAHPCPUK	Maku Handset - Chrome & Graphite	£23.40	£28.08	39
HSR 9	Seal Flow Regulator - 9 L/min Replaces standard seal	£2.95	£3.54	85	MCK001	Universal Conversion Kit - Chrome	£21.23	£25.48	164
INB0CPUK	Indra Basin Mixer - Chrome	£120.79	£144.95	59	MCTS	Maku Cool to Touch Bar Shower - Chrome & Graphite	£140.45	£168.54	40
INB0CPUK	Indra Bath Filler - Chrome	£176.97	£212.36	59	MT172	Metropolis Mono Sink Mixer - Chrome	£141.57	£169.88	123
INBMSCPUK	Indra Bath Shower Mixer - Chrome	£205.06	£246.07	59	METHSQELB	Square Wall Union - Chrome	£51.49	£61.79	48
INS101	Insignia Basin Taps - Chrome	£74.33	£89.20	106	MFH001	Slim Brass Fixed Head Shower - Chrome	£234.08	£280.90	43
INS101/FR101-4	Insignia Basin Taps - Chrome	£74.33	£89.20	106	MFH002	Slim Brass Fixed Head Shower - Chrome	£271.54	£325.85	44
INS102	Insignia Bath Taps - Chrome	£86.72	£104.06	107	MH1	Microphone Handset - Chrome	£37.45	£44.94	41
INS106	Insignia Deck Mounted Bath Shower Mixer - Chrome	£155.14	£186.17	107	MILAN 101	Milan Basin Taps - Chrome	£35.39	£42.47	130
INS108	Insignia Deck Mounted Bath Filler - Chrome	£136.26	£163.51	107	MILAN 102	Milan Bath Taps - Chrome	£39.53	£47.44	130
INS113	Insignia Mono Basin Mixer - Chrome	£99.10	£118.92	106	MILAN 103	Milan Mono Sink Mixer - Chrome	£43.65	£52.38	127
INS120	Insignia Mono Basin Mixer - Chrome	£99.10	£118.92	106	MILAN 104	Milan Mono Sink Mixer - Chrome	£101.46	£121.75	125
INS313	Insignia Mini Mono Basin Mixer - Chrome	£70.79	£84.95	106	MILAN 105	Milan Deck Mounted Sink Mixer - Chrome	£76.69	£92.03	126
INS313W	Insignia Mini Mono Basin Mixer - Chrome	£83.51	£100.21	106	MILAN 106	Milan Deck Mounted Bath Shower Mixer - Chrome	£123.88	£148.66	131
KAHA 111	Kaha 3 Hole Deck-Mounted Basin Mixer - Chrome	£210.68	£252.82	51	MILAN 108	Milan Deck Mounted Bath Filler - Chrome	£111.49	£133.79	131
KAHA 113	Kaha Basin Mixer With Swivel Base - Chrome	£163.85	£196.62	51	MILAN 113	Milan Mono Basin Mixer With Pop Up Waste - Chrome	£86.72	£104.06	130
KAHA 134	Kaha 3 Hole Deck-Mounted Bath Mixer - Chrome	£234.08	£280.90	51	MILAN 113/SW	Milan Mono Basin Mixer With Swivel Spout And Pop Up Waste - Chrome	£93.21	£111.85	130
KAHA 1V	Kaha Concealed Mixer Valve (Single Outlet) - Chrome (Brass)	£279.97	£335.96	27	MILAN SPEC101	Milan Basin Taps - Chrome	£38.35	£46.02	130
KAHA 1VA	Kaha Concealed Mixer Valve (Single Outlet) - Chrome (ABS plate)	£235.80	£282.96	27	MILAN SPEC102	Milan Bath Taps - Chrome	£42.48	£50.98	130
KAHA 2VDIV	Kaha Concealed Mixer Valve (2 outlets) - Chrome (Brass)	£326.78	£392.14	27	MILAN SPEC108	Milan Deck Mounted Bath Filler - Chrome	£115.04	£138.05	131
KAHA 2VDIVA	Kaha Concealed Mixer Valve (2 outlets) - Chrome (ABS plate)	£282.61	£339.13	27	MK1	Maku Shower Kit - Chrome & Graphite	£50.56	£60.67	39
KAHA 3VDIV	Kaha Concealed Mixer Valve (3 Outlets) - Chrome (Brass)	£420.42	£504.50	28	MOT101	Motif Basin Taps - Chrome	£74.33	£89.20	108
KAHA 3VDIVA	Kaha Concealed Mixer Valve (3 Outlets) - Chrome (ABS plate)	£376.25	£451.50	28	MOT102	Motif Bath Taps - Chrome	£86.72	£104.06	108
KASP200CPUK	Kaha Bath Wall Spout - Chrome	£102.06	£122.47	51	MOT106	Motif Deck Mounted Bath Shower Mixer - Chrome	£155.14	£186.17	108
KCTS	Kiri Cool To Touch Bar Shower - Chrome & Graphite	£186.33	£223.60	37	MOT108	Motif Deck Mounted Bath Filler - Chrome	£136.26	£163.51	109
KCTSDEF	Kiri Cool To Touch Bar Shower with Diverter - Chrome & Graphite	£373.60	£448.32	37	MOT113	Motif Mono Basin Mixer - Chrome	£99.10	£118.92	108
KEBCPUK	Kea Mono Basin Mixer - Chrome	£102.06	£122.47	56	NCT001	Non Concussive Pre-Set Basin Taps - Chrome	£68.42	£82.10	146
KEBFCPUK	Kea Bath Filler - Chrome	£148.88	£178.66	57	NCT002	Non Concussive Pre-Set Exposed Shower Valve - Chrome	£74.33	£89.20	147
KEBMCPUK	Kea Mini Basin Mixer - Chrome	£92.70	£111.24	56	NCT003	Non Concussive Pre-Set Recessed Shower Valve - Chrome	£80.81	£96.97	147
KEBSMCPK	Kea Bath Shower Mixer - Chrome	£176.97	£212.36	57	NLT103	Lever Action Sink Taps - Chrome	£72.08	£86.50	125
KESCTS	Kestrel Cool To Touch Bar Shower with Single Mode Kit - Chrome	£92.70	£111.24	66	NLT104	Lever Action Mono Sink Mixer - Chrome	£116.60	£139.92	126
KESSMCP	Kea Sequential Valve & Kit - Chrome & Graphite	£205.06	£246.07	40	NLT105	Lever Action Deck Mounted Sink Mixer - Chrome	£103.88	£124.66	126
KETBCPUK	Kea Basin Pillar Taps - Chrome	£92.70	£111.24	56	OBFC	Overflow Bath Filler with Clicker or Pop Up Waste - Chrome	£163.85	£196.62	61
KETBTCPUK	Kea Bath Pillar Taps - Chrome	£102.06	£122.47	56	OBFP	Overflow Bath Filler with Clicker or Pop Up Waste - Chrome	£154.50	£185.40	61
KIRI 111	Kiri 3 Hole Deck-Mounted Basin Mixer - Chrome	£210.68	£252.82	53	OSQ230CP	Square Fixed Head Shower - Chrome & Graphite	£139.52	£167.42	43
KIRI 113	Kiri Basin Mixer - Chrome	£163.85	£196.62	53	OSQ230WHCPUK	Square Fixed Head Shower - Chrome & White	£139.52	£167.42	43
					PEV002	Pressure Equalising Valve - Brass	£102.05	£122.46	148
					PHK1	Stanjel Rail System - Chrome & Graphite	£111.43	£133.72	47
					PTW300/017	1½" Basin Slotted Press Top Waste - Chrome	£15.34	£18.41	154



INDEX OF PRODUCTS

Code	Description	Ex.VAT	Inc.VAT	Page	Code	Description	Ex.VAT	Inc.VAT	Page
PTW404/017	1½" Bath Press Top Waste - Chrome	£29.50	£35.40	156	SPE05	Wall Bracket - Chrome	£8.85	£10.62	160
PUF130/CP	Puffin Mono Sink Mixer - Chrome	£130.37	£156.44	124	SPE05/G	Wall Bracket - Gold	£21.43	£25.72	160
PWW200	1½" Bath Waste - Chrome	£31.26	£37.51	156	SPE06	Wall Bracket - Chrome	£18.29	£21.95	160
PWW200/501	1½" Bath Waste - Gold	£56.94	£68.33	156	SPE08	Hose Retainer - Chrome	£4.13	£4.96	161
PUW206	1½" Bath Fill And Overflow Waste - Chrome	£111.49	£133.79	155	SPE09	Hose Retainer Wall Mounted - Chrome	£11.20	£13.44	161
REBMEF	Response Bar Shower With Multi Mode Kit - Chrome	£205.28	£246.34	65	SPE10	Wall Plate For Bar Showers - Chrome	£37.76	£45.31	88
RLE04S	Adjustable Bath Pipe Shrouds - Chrome	£185.82	£222.98	162	SPE11	Easy Fix For Bar Showers - Chrome	£31.26	£37.51	89
ROUVDUAT01	Contemporary Dual Control Shower Valve - Chrome	£223.56	£268.27	75	SPE11SQ	Easy Fix For Bar Showers (Square) - Chrome	£31.26	£37.51	89
RPB	Round Parking Bracket - Chrome	£46.82	£56.18	49	SPE12	Shower Rail - Chrome	£33.62	£40.34	88
RUB 101	Rubic Basin Taps - Chrome	£93.21	£111.85	102	SPE13	Brass Straight Nipple And Back Nut ½" - Brass	£8.26	£9.91	161
RUB 102	Rubic Bath Taps - Chrome	£105.59	£126.71	102	SPE14	Adjustable Riser Rail - Chrome	£42.12	£50.54	88
RUB 106	Rubic Deck Mounted Bath Shower Mixer - Chrome	£217.08	£260.50	102	SPE15	Adjustable Riser Rail - Chrome	£25.27	£30.32	88
RUB 108	Rubic Deck Mounted Bath Filler - Chrome	£161.04	£193.25	103	SSV	Sol Sequential Valve - Chrome	£186.33	£223.60	75
RUB 113	Rubic Mono Basin Mixer - Chrome	£117.98	£141.58	102	SWO106	Swoop Deck Mounted Bath Shower Mixer - Chrome	£226.13	£271.36	94
RUHSCPUK	Rua Handset - Chrome	£87.45	£104.94	18	SWO108	Swoop Deck Mounted Bath Filler - Chrome	£176.97	£212.36	94
RUHSCPWHUK	Rua Handset - Chrome & White	£87.45	£104.94	18	SWO113	Swoop Mono Basin Mixer - Chrome	£142.55	£171.06	94
RUWOBPCPUK	Rua Hand Shower - Chrome	£166.95	£200.34	18	SWO113/EX	Swoop Tall Mono Basin Mixer - Chrome	£147.48	£176.98	94
RUWOBPCWHUK	Rua Hand Shower - Chrome & White	£166.95	£200.34	18	TAHI 1000	Tahi Concealed Mixer Valve (Single Outlet) - Chrome	£468.17	£561.80	25
RUSRCPUK	Rua Rail Shower - Chrome	£195.22	£234.26	19	TAHI 2000	Tahi Concealed Mixer Valve (2 Outlets) - Chrome	£561.80	£674.16	25
RUSRCPWHUK	Rua Rail Shower - Chrome & White	£195.22	£234.26	19	TAUR130	Taurus Mono Sink Mixer - Chrome	£147.48	£176.98	123
RUCTSCPUK	Rua Cool To Touch Bar Mixer Shower Kit - Chrome	£294.15	£352.98	19	TBVO08	Thermostatic 15mm Blending Valve - Chrome	£97.92	£117.50	149
RUCTSCPWHUK	Rua Cool To Touch Bar Mixer Shower Kit - Chrome & White	£294.15	£352.98	19	TBVO09	Thermostatic 28mm Blending Valve - Chrome	£867.14	£1,040.57	149
SAC290	Ceiling Shower Arm - Chrome	£56.18	£67.42	48	TBVO10	Thermostatic 22mm Blending Valve - Chrome	£111.07	£133.28	149
SAVBSEF	Savvi Bar Shower With Single Mode Kit - Chrome	£261.32	£313.58	66	TOP625	1¼" Bottle Trap With Wall Extension - Chrome	£37.16	£44.59	158
SAV106	Savvi Deck Mounted Bath Shower Mixer - Chrome	£226.13	£271.36	92	TOP625/501	1¼" Bottle Trap With Wall Extension - Gold	£63.05	£75.66	158
SAV108	Savvi Deck Mounted Bath Filler - Chrome	£176.97	£212.36	93	TOP626	Square Bottle Trap With Wall Extension - Chrome	£60.00	£72.00	159
SAV113	Savvi Mono Basin Mixer - Chrome	£142.55	£171.06	92	TLV106	Kiri Thermostatic Pillar Mounted Bath Shower Mixer - Chrome	£284.92	£341.90	54
SAV113/EX	Savvi Tall Mono Basin Mixer - Chrome	£147.48	£176.98	92	TLV106WM	Kiri Thermostatic Wall Mounted Bath Shower Mixer - Chrome	£284.92	£341.90	54
SAVV313	Savvi Mini Mono Basin Mixer - Chrome	£108.15	£129.78	92	TUD01	Tudor Basin Taps - Chrome	£34.80	£41.76	118
SAVV313W	Savvi Mini Mono Basin Mixer - Chrome	£120.87	£145.04	92	TUD01/501	Tudor Basin Taps - Gold	£60.60	£72.72	118
SAW148	Wall-Mounted Shower Arm - Chrome	£28.09	£33.71	48	TUD02	Tudor Bath Taps - Chrome	£37.16	£44.59	118
SAW320	Over Head Wall Shower Arm - Chrome	£28.09	£33.71	48	TUD02/501	Tudor Bath Taps - Gold	£63.05	£75.66	118
SCTSDZF	Savvi Cool To Touch Bar Shower with Diverter to Fixed Head & Handset - Chrome	£362.17	£434.60	69	TUD03	Tudor Pillar Mounted Bath Shower Mixer - Chrome	£148.65	£178.38	119
SENSOR8/D	SENSOR8/D - Chrome	£279.97	£335.96	151	TUD03/501	Tudor Pillar Mounted Bath Shower Mixer - Gold	£215.48	£258.58	119
SENSOR1/D	SENSOR1/D - Chrome	£279.01	£334.81	150	TUD08	Tudor Pillar Mounted Bath Filler - Chrome	£117.98	£141.58	119
SENSOR10/W	SENSOR10/W - Chrome	£326.78	£392.14	152	TUD08/501	Tudor Pillar Mounted Bath Filler - Gold	£171.40	£205.68	119
SENSOR2/D	SENSOR2/D - Chrome	£340.96	£409.15	150	TUD113	Tudor Mono Basin Mixer With Pop Up Waste - Chrome	£86.72	£104.06	118
SENSOR3/D	SENSOR3/D - Chrome	£340.96	£409.15	150	TUD113/501	Tudor Mono Basin Mixer With Pop Up Waste - Gold	£126.72	£152.06	118
SENSOR4/D	SENSOR4/D - Chrome	£279.01	£334.81	150	TUD114	Tudor Bidet Mixer With Pop Up Waste - Chrome	£99.10	£118.92	118
SENSOR6/BT	SENSOR6/BT - Chrome	£279.01	£334.81	151	TUD114/501	Tudor Bidet Mixer With Pop Up Waste - Gold	£139.57	£167.48	118
SENSOR7/D	SENSOR7/D - Chrome	£279.97	£335.96	151	V2	Standard Deva Valve ½" - Brass	£9.43	£11.32	163
SENSOR9/W	SENSOR9/W - Chrome	£326.78	£392.14	151	VIC CONV.KIT	Period Style Conversion Kit BS5412 Only - Chrome	£32.45	£38.94	164
SHA01	Shafaf With Hose And Wall Bracket - Chrome	£17.79	£21.35	146	VIC CONV. KIT/501	Period Style Conversion Kit BS5412 Only - Gold	£58.16	£69.79	164
SHA02	Shafaf With Hose And Wall Bracket - Brass	£27.16	£32.59	147	VSN 1S	Vision Mono Bath Shower Mixer Floor Mounted - Chrome	£309.69	£371.63	97
SHTLV106/2BK	Kiri Thermostatic Pillar Mounted Bath Shower Mixer - Chrome	£336.15	£403.38	54	VSN104	Vision Mono Sink Mixer With Arch Spout - Chrome	£192.31	£230.77	122
SIGKITM02	Substance 3 Mode Signature Kit - Chrome	£62.53	£75.04	80	VSN113	Vision Mono Basin Mixer - Chrome	£155.14	£186.17	96
SIGKITSO1	Core Single Mode Signature Shower Kit - Chrome	£37.76	£45.31	78	VSN113/EX	Vision Tall Mono Basin Mixer - Chrome	£235.36	£282.43	96
SJK 002	Kiri Satinjet® Wall Mounted Showerhead - Chrome & Graphite	£55.25	£66.30	34	VSN115	Vision Sink Mixer With Pull Out Rinser - Chrome	£222.98	£267.58	121
SJK 009	Round Fixed Head Shower - Chrome & Graphite	£139.52	£167.42	42	VSN122	Vision Wall Mounted Basin Mixer - Chrome	£179.91	£215.89	96
SJK005	Kiri Shower Head - Chrome & Graphite	£28.09	£33.71	33	VSN123	Non Concussive Vision Self Closing Basin Tap - Chrome	£111.49	£133.79	146
SJK005-LF	Kiri Satinjet® Low Flow Shower Head - Chrome & Graphite	£28.09	£33.71	34	VSN123	Non Concussive Vision Self Closing Basin Tap - Chrome	£111.49	£133.79	97
SJK010	Flush Mounted Ceiling Shower - Chrome & Graphite	£176.97	£212.36	42	VSN206	Vision Deck Mounted Bath Shower Mixer - Chrome	£235.36	£282.43	97
SJK23	Kiri Handset - Chrome & Graphite	£28.09	£33.71	32	VSN208	Vision Deck Mounted Bath Filler - Chrome	£185.82	£222.98	97
SJK23-LF	Kiri Low Flow Handset - Chrome & Graphite	£28.09	£33.71	32	VSN2BMEF	Vision Bar Shower with Multi Mode Kit - Chrome	£223.56	£268.27	65
SJT006	Tahi Shower System - Chrome & Graphite	£889.52	£1,067.42	24	VSN313	Vision Mini Mono Basin Mixer - Chrome	£105.59	£126.71	96
SJT23	Tahi Handset - Chrome & Graphite	£65.54	£78.65	24	VSN313W	Vision Mini Mono Basin Mixer - Chrome	£118.31	£141.97	96
SLINKY104	Slinky Mini Mono Sink Mixer - Chrome	£192.31	£230.77	122	VSN625	1¼" Bottle Trap With Wall Extension - Chrome	£50.00	£60.00	158
SLINKY118	Slinky Mono Sink Mixer - Chrome	£279.01	£334.81	121	VSNBDEF	Vision Bar Shower With Diverter To Fixed Head & Handset - Chrome	£372.81	£447.37	68
SM054	Brittany Mono Sink Mixer - Chrome	£167.53	£201.04	129	VSNBMEF	Vision Bar Shower With Multi Mode Kit - Chrome	£174.02	£208.82	64
SM054/501	Brittany Mono Sink Mixer - Gold	£210.58	£252.70	129	VSNCCONT03	Vision Concentric Shower With Multi Mode Kit - Chrome	£434.75	£521.70	70
SM056	Georgian Mono Sink Mixer - Chrome	£210.59	£252.71	128	VSNVCONT04	Vision Concentric Shower Valve - Chrome	£353.93	£424.72	70
SM056/501	Georgian Mono Sink Mixer - Gold	£255.27	£306.32	128	VSNVSEQT01	Vision Exposed Sequential Shower Valve - Chrome	£324.44	£389.33	74
SM056/BZ	Georgian Mono Sink Mixer - Bronze	£247.75	£297.30	128	VSNVSEQT02	Vision Concealed Sequential Shower Valve - Chrome	£324.44	£389.33	74
SM056/NI	Georgian Mono Sink Mixer - Nickel	£316.18	£379.42	128	WERT01	Vertical L Shaped Bar Shower Valve - Chrome	£107.36	£128.83	69
SM057	Venetian Mono Sink Mixer - Chrome	£111.49	£133.79	129	WABCPUK	Waipori Basin Mixer - Chrome	£163.85	£196.62	52
SM057/501	Venetian Mono Sink Mixer - Gold	£152.43	£182.92	129	WABHCPUK	Waipori 3 Hole Deck-Mounted Bath Mixer - Chrome	£234.08	£280.90	52
SM057/NI	Venetian Mono Sink Mixer - Nickel	£185.82	£222.98	129	WABSCPUK	Waipori 3 Hole Deck Mounted Basin Mixer - Chrome	£210.68	£252.82	52
SMS172	Sauris Mono Sink Mixer - Chrome	£105.59	£126.71	124	WAHPCPUK	Waipori Handset - Chrome & Graphite	£37.45	£44.94	29
SMS172/004	Sauris Mono Sink Mixer - Beige	£123.88	£148.66	124	WAHSCPWHUK	Waipori Handset - Chrome & White	£37.45	£44.94	29
SMS172/005	Sauris Mono Sink Mixer - White	£123.88	£148.66	124	WASPH200CPUK	Waipori Deck-Mounted Swivel Bath Spout - Chrome	£121.72	£146.06	52
SOL002B	Lever Action Sequential Control Spray Mono Mixer - Chrome	£198.20	£237.84	138	WASRCPUK	Waipori Shower Head - Chrome & Graphite	£37.45	£44.94	30
SOL003	Thermostatic TMV3 Sequential Lever Mono Basin Mixer - Chrome	£247.75	£297.30	148	WCTS	Waipori Cool To Touch Bar Shower - Chrome & Graphite	£176.97	£212.36	30
SOLBEF	Sol Bar Shower - Chrome	£292.60	£351.12	41	WCTSDEF	Waipori Cool To Touch Bar Shower with Diverter - Chrome & Graphite	£454.92	£545.90	31
SOLE101	Solerno Basin Taps - Chrome	£35.39	£42.47	132	WFMS001	Str3Am Mono Water Filter Tap - Chrome	£322.08	£386.50	121
SOLE102	Solerno Bath Taps - Chrome	£40.70	£48.84	132	WK1	Waipori Shower Kit - Chrome & Graphite	£61.80	£74.16	29
SOLE106	Solerno Deck Mounted Bath Shower Mixer - Chrome	£123.88	£148.66	132	WOB	Wall Outlet Bracket - Chrome	£56.18	£67.42	49
SOLE108	Solerno Deck Mounted Bath Filler - Chrome	£111.49	£133.79	133	WST20/017	1¼" Plastic Basin Waste - Chrome	£10.03	£12.04	155
SOLE113	Solerno Mono Basin Mixer With Pop Up Waste - Chrome	£86.72	£104.06	132	WST27/017	1½" Basin, 1½" Bath Waste And Overflow Set - Chrome	£15.93	£19.12	157
SPO1/CARE DLT	Care indice	£2.34	£2.81	134	WST27/501	1¼" Basin, 1½" Bath Waste And Overflow Set - Gold	£41.02	£49.22	157
SPA106	Sparkle Deck Mounted Bath Shower Mixer - Chrome	£285.12	£342.14	90	WST27/BATH	1½" Bath Waste And Overflow - Chrome	£13.57	£16.28	157
SPA108	Sparkle Deck Mounted Bath Filler - Chrome	£260.53	£312.64	91	WST304	Round Clicker Waste - Chrome	£37.45	£44.94	61
SPA113	Sparkle Mono Basin Mixer - Chrome	£186.79	£224.15	90	WST307	Free Flow Waste - Chrome	£37.45	£44.94	61
SPA113/EX	Sparkle Tall Mono Basin Mixer - Chrome	£260.53	£312.64	90	WST318	Square Clicker Waste - Chrome	£42.14	£50.57	61
SPA313	Sparkle Mini Mono Basin Mixer - Chrome	£157.30	£188.76	90	WSTGR112/UNS	1½" Bath Unslotted Waste - Chrome	£13.78	£16.54	158
SPA313W	Sparkle Mini Mono Basin Mixer - Chrome	£170.02	£204.02	90	WSTGR114/S	1½" Basin Slotted Waste - Chrome	£9.01	£10.81	154
SPB	Square Parking Bracket - Chrome	£46.82	£56.18	49	WSTGR114/UNS	1½" Basin Unslotted Waste - Chrome	£9.54	£11.45	154
SPE01	Wall Union Round - Chrome	£19.66	£23.59	87	WUR	Round Wall Union - Chrome	£51.49	£61.79	48
SPE01/G	Wall Union Round - Gold	£34.65	£41.58	87	XTSPIND	Concealed Shower Spindle Extension - Chrome	£84.80	£101.76	160
SPE03	Wall Union Round - Chrome	£21.62	£25.94	87					
SPE04	Exposed Elbows For Bar Showers - Chrome	£37.76	£45.31	160					

TERMS AND CONDITIONS OF SALE

1. Definitions

In these standard terms and conditions:

1.1 the following words and expressions will have the following meanings unless the context otherwise requires:

"Applicable Law" means any: (a) statute, statutory instrument, bye law, order, regulation, directive, treaty, decree, decision of the European Council or law (including any common law or civil law judgment, demand, order or decision of any court, regulator or tribunal); and/or (b) legally binding rule, policy, guidance or recommendation issued by any governmental, statutory or regulatory body in each case which relates to the Contract and/or the Goods;

"Business Day" means a day that is not a Saturday, Sunday or public or bank holiday in England;

"Conditions" means these standard terms and conditions of sale together with any special terms agreed in writing between the Customer and Methven;

"Contract" means the contract between Methven and the Customer for the sale and purchase of the Goods formed in accordance with Condition 2;

"Customer" means the person whose Order for Goods is accepted by Methven in accordance with Condition 2.3;

"Delivery Point" means the place where delivery of the Goods is to take place under Condition 5.1 as set out in the Order;

"Force Majeure Event" means any (a) act of God; (b) war, insurrection, riot, civil commotion, act or threat of terrorism; (c) lightning, earthquake, fire, flood, storm or extreme weather condition; (d) theft, malicious damage; (e) strike, lockout or industrial dispute (whether affecting the workforce of Methven and/or any other person); (f) breakdown or failure of plant or machinery; (g) inability to obtain essential supplies or materials; (h) change in Applicable Law; (i) failure or default of a supplier or sub-contractor of Methven; or (j) event or circumstance to the extent it is beyond the reasonable control of Methven;

"Goods" means any goods which Methven supplies to the Customer (including any of them or any part of them) under a Contract;

"Insolvent" the Customer is insolvent where it: (a) ceases, threatens to cease or, in Methven's reasonable opinion appears likely to cease, to trade; (b) goes into liquidation or bankruptcy (or has a petition for its winding up or bankruptcy presented or passes a resolution for its winding up); (c) goes into administration (or is subject to an administration order or an application for an administration order made in respect of it); (d) has a receiver or administrator appointed over some or all of its assets or proposes an arrangement or compromise with its creditors; or (e) is the subject of anything analogous to the foregoing under the laws of any applicable jurisdiction;

"Methven" means Methven UK Limited (registered number 06290166) whose registered office is at Eversheds House, 70 Great Bridgewater Street, Manchester, M1 5EJ;

"Order" means a request by the Customer to purchase Goods from Methven; and

"Prices" means the price(s) of the Goods set out in Methven's price list in force at the date of dispatch of the Goods or such other price(s) as agreed by the parties in writing;

1.2 all headings are for ease of reference only and will not affect the construction or interpretation of the Conditions;

1.3 unless the context otherwise requires:

1.3.1 references to the singular include the plural and vice versa and references to any gender include every gender;

1.3.2 references to a "person" include any individual, body corporate, association, partnership, firm, trust, organisation, joint venture, government, local or municipal authority, governmental or supra-governmental agency or department, state or agency of state or any other entity (in each case whether or not having separate legal personality);

1.4 references to any statute or statutory provision will include any subordinate legislation made under it and will be construed as references to such statute, statutory provision and/or subordinate legislation as modified, amended, extended, consolidated, re-enacted and/or replaced and in force from time to time; and

1.5 any words following the words "include", "includes", "including", "in particular" or any similar words or expressions will be construed without limitation and accordingly will not limit the meaning of the words preceding them.

2. Formation and Incorporation

2.1 Subject to Condition 2.7, these Conditions apply to all Orders and Contracts for the supply of Goods by Methven to the Customer. Methven's acceptance of any Order placed by the Customer is strictly conditional upon the Customer's acceptance of these Conditions and by placing an Order the Customer confirms its unconditional acceptance of these Conditions to the exclusion of all other terms and conditions which the Customer purports to apply under the Order, confirmation of order or similar document (including those stipulated or referred to by the Customer during the course of pre-contract discussions and/or negotiations) whether or not such document is referred to in the Contract.

2.2 Methven may update these Conditions from time to time. The current version of Methven's Conditions (as updated) can be found at www.methven.com/uk (the "URL").

2.3 Each Order or acceptance by the Customer of a quotation for Goods will be deemed to be an offer by the Customer to purchase Goods upon the most recent version of these Conditions (as available at the URL) at the time that the Order is placed or the quotation for Goods is accepted. The Contract is formed when the order is accepted by Methven by way of a written acknowledgement of order or by processing the Order (whichever the earlier).

2.4 The Customer must ensure that the terms of its Order and any applicable specification are complete and accurate.

2.5 Acceptance of delivery of the Goods will be deemed conclusive evidence of the Customer's acceptance of these Conditions.

2.6 Methven may cancel the Contract at any time prior to delivery.

2.7 Save as otherwise expressly provided in the Contract, no variation

to the Contract (including these Conditions) will be effective unless it is in writing and signed by a duly authorised representative on behalf of Methven. Any oral undertakings or instructions issued and/or received by Methven's employees shall not bind Methven unless it has confirmed them in writing.

2.8 A quotation for the Goods given by Methven shall not constitute an offer. A quotation shall only be valid for a period of 30 Business Days from its date of issue, unless otherwise agreed in writing by Methven.

3. Description and Specification

3.1 All samples and information, prices, specifications, descriptions and/or colour of illustrations shown in Methven's catalogues, advertisements, brochures, on Methven's website or in any other communications from or on behalf of Methven from time to time are indicative, subject to change without notice and shall under no circumstances form part of the Contract or otherwise bind Methven.

3.2 Methven may make any changes to the specification, design, materials or finishes of the Goods which:

3.2.1 are required to conform with any Applicable Laws; or

3.2.2 do not materially affect their quality or performance.

3.3 Where Goods are made to the Customer's own specification or design ("Specification"), the Customer undertakes full responsibility for the suitability and fitness of the Specification and will indemnify, keep indemnified and hold harmless Methven in full and on demand against all actions, claims, costs, demands, expenses and damages (including without limit for legal actions) however suffered or incurred by Methven in the event that any claim or claims are made or alleged against Methven relating to the Specification and/or the manufacture, use, sale, import and/or export of any Goods based on the Specification.

4. Price and Payment

4.1 Except as set out in Condition 4.3 or as otherwise agreed in writing by the parties, the Prices are exclusive of insurance, carriage and delivery costs which will be payable by the Customer in addition to the Prices. Any sum payable under the Contract is exclusive of value added tax (and any other similar or equivalent taxes, duties, fees and levies imposed from time to time by any government or other authority) which will be payable in addition to that sum in the manner and at the rate prescribed by law from time to time.

4.2 Methven will be entitled to vary the Prices:

4.2.1 following any request by the Customer to change the delivery date(s), quantities or types of Goods ordered;

4.2.2 following any changes in the specification made at the request of the Customer and agreed by Methven;

4.2.3 to cover any extra expense as a result of the Customer's instructions or lack of instructions and/or a failure of the Customer to give Methven adequate or accurate information;

4.2.4 to comply with the requirements referred to in Condition 3.2.1;

4.2.5 to cover any increase in the cost to Methven of manufacturing or selling the Goods including foreign exchange fluctuations, increases in taxes and duties and/or the application of any new taxes or duties including import tariffs, and increases in labour, materials and/or manufacturing costs; and/or

4.2.6 to cover any increase in the cost to Methven of supplying any Goods and/or complying with any of its obligations under the Contract where such increases are caused in whole or in part (directly or indirectly) by any factor(s) outside the reasonable control of Methven.

Methven will give written notice of the variation to the Customer.

4.3 Where the Price for the Goods contained in any Order for delivery:

4.3.1 to the United Kingdom (excluding Northern Ireland and all Scottish islands) is equal to or greater than £50.00 (fifty pounds sterling) excluding VAT, the Price includes the cost of carriage to the contracted place of delivery;

4.3.2 to the United Kingdom (excluding Northern Ireland and all Scottish islands) is less than £50.00 (fifty pounds sterling) excluding VAT, a delivery charge of £5.00 (five pounds sterling) will be payable by the Customer to Methven in addition to the Price;

4.3.3 to Northern Ireland, the Republic of Ireland, the Channel Islands or the Isle of Man is equal to or greater than £200.00 (two hundred pounds sterling) excluding VAT, the Price includes the cost of carriage to the contracted place of delivery;

4.3.4 to Northern Ireland, the Republic of Ireland, the Channel Islands or the Isle of Man is less than £200.00 (two hundred pounds sterling) excluding VAT, a delivery charge of £20.00 (twenty pounds sterling) will be payable by the Customer to Methven in addition to the Price, and in each case, Methven will deliver the Goods to the contracted place of delivery by the means most convenient to Methven.

4.4 The Customer will pay the Prices to Methven in accordance with this Condition 4. All payments will be made in cleared funds in the currency in which the sums payable are expressed on Methven's invoice.

4.5 Payment for Goods by credit or debit card will incur at the time of payment a surcharge of 2% of the Price of the Goods, or such other rate as notified in writing to the Customer by Methven from time to time.

4.6 Methven will be entitled to invoice the Customer for the Prices for the Goods and any applicable insurance, carriage and delivery costs payable by the Customer in addition to the Prices following dispatch of the Goods to the Customer.

4.7 Unless otherwise agreed in writing by Methven, each invoice will be payable by the Customer not later than 30 days following the month in which the invoice is issued. Time for payment by the Customer shall be of the essence of the Contract.

4.8 Notwithstanding any purported contrary appropriation by the Customer, Methven will be entitled, by giving written notice to the Customer, to appropriate any payment by the Customer to any invoice issued by Methven.

4.9 If any sum payable under the Contract is not paid on or before the due date for payment Methven will be entitled to charge the Customer interest on that sum at 4% per annum above the base lending rate from

time to time of the Bank of England from the due date until the date of payment (whether before or after judgment) compounding annually, such interest to accrue on a daily basis.

4.10 Notwithstanding Condition 4.9, Methven may, at its sole discretion and as an alternative to Condition 4.9, claim interest under the Late Payment of Commercial Debts (Interest) Act 1998.

4.11 Save as otherwise expressly provided in the Contract or required by law, all payments to be made by the Customer to Methven under the Contract will be made in full and without any set-off or any deduction or withholding including on account of any counter-claim.

4.12 Methven will be entitled to invoice and the Customer will pay (within 30 days following the date on which the invoice was issued) the sum of £25.00 or, if greater, any sums payable by Methven to any financial institution as a result of one or more cheques failing to pass such financial institution's cheque clearing process at the first attempt.

4.13 The Customer will pay to Methven all costs, expenses and disbursements incurred by Methven (including debt collection costs, agency fees and commissions and legal costs) relating to the recovery by Methven of any amounts not paid when due by the Customer under these Conditions.

4.14 In the event that Methven agrees to apply discounted Prices to the Customer's Orders of particular Goods for a fixed time period and/or in respect of a specified quantity of Goods (a "Fixed Term Quotation") and Methven provides the Customer with a quotation number in respect of the Fixed Term Quotation, the application of the discounted Price to an Order is conditional on the Customer quoting the quotation number and/or the agreed discounted Price at the time of placing such Order. If the Customer fails to quote the quotation number or the agreed discounted price at the time of placing an Order (i) the discounted Prices will not be applied to the Order; and (ii) no credits or other adjustments will be made to the Price payable for the ordered Goods once the Order has been accepted by Methven. At the end of the period of fixed term pricing, the Price for the Goods will be the Price set out in Methven's price list in force at the date of dispatch of the Goods from Methven to the Customer.

5. Delivery

5.1 The Goods will be delivered to the Delivery Point. Where the Delivery Point is a location other than Methven's place of business, the Customer shall be solely responsible for (i) providing Methven with a correct address for delivery, suitable access having regard to the size and nature of the delivery and (ii) no less than 5 Business Days prior to Methven's proposed delivery date, notifying Methven in writing of any changes to the delivery address and the Customer's contact details.

5.2 Any dates quoted for delivery are approximate only. Methven will use reasonable endeavours to deliver each of the Customer's orders for the Goods within the time agreed when the Customer places an Order and, if no time is agreed, then within a reasonable time, but the time of delivery will not be of the essence. If, despite those endeavours, Methven is unable for any reason to fulfil any delivery or performance on the specified date, Methven will not be in breach of the relevant Contract, nor (for the avoidance of doubt), subject to Condition 9.5, will Methven have any liability to the Customer for direct, indirect or consequential loss (all three of which terms include pure economic loss, loss of profits, loss of business, depletion of goodwill and like loss) howsoever caused (including as a result of negligence) by any delay or failure in delivery. Any delay in delivery will not entitle the Customer to cancel the Order unless and until the Customer has given 5 Business Days' written notice to Methven requiring the delivery to be made and Methven has not fulfilled the delivery within that period. If the Customer cancels the order in accordance with this Condition 5.2 then:

5.2.1 Methven will refund to the Customer any sums which the Customer has paid to Methven in respect of that Order or part of the Order which has been cancelled; and

5.2.2 The Customer will be under no liability to make any further payments under Condition 4.3 in respect of that Order or part of the Order which has been cancelled.

5.3 Methven shall not be in breach of Condition 5.2 and, subject to Condition 9.5, shall have no liability to the Customer for any delay in delivery of the Goods or failure to deliver the Goods which arises out of or in connection with the Customer's failure to provide Methven with adequate delivery instructions or other information reasonably required to enable Methven to comply with Condition 5.2.

5.4 Methven shall be entitled to defer or withhold delivery of the Goods until all monies due from the Customer under the Contract or any other contract between Methven and the Customer have been received by Methven.

5.5 Where the Delivery Point is Methven's place of business, (i) the Customer will take delivery of the Goods within five Business Days of Methven giving it notice that the Goods are ready for delivery; (ii) delivery of the Goods will be made during Methven's usual business hours; and (iii) delivery shall be deemed to occur upon the taking of possession of the Goods by the Customer. Where the Delivery Point is not Methven's place of business, delivery of the Goods will be accepted at any time of day and delivery shall be deemed to occur upon commencement of unloading the Goods from the delivery vehicle.

5.6 The Customer will be responsible for loading or off-loading (as applicable) the Goods at the Delivery Point and, where the Delivery Point is not Methven's place of business, the Customer will provide of its risk and expense adequate and appropriate equipment and manual labour for such loading or off-loading.

5.7 Methven may deliver the Goods by separate instalments. Methven will be entitled to invoice the Price for each instalment separately in accordance with Condition 4.6.

5.8 Each instalment will be a separate Contract and no cancellation or termination of any one Contract relating to an instalment will entitle the Customer to repudiate or cancel any other Contract or instalment.

5.9 In the case of goods to be sent by sea, Methven shall be under no obligation to give the Customer any notice for the purposes of Section 32(3) of the Sale of Goods Act 1979.



6. Risk and Ownership

- 6.1 The risk of damage to or loss of the Goods shall pass to the Customer on delivery.
- 6.2 The Customer will inspect the Goods on delivery and will, as soon as possible and in any event within seven days from and including the date of delivery, give notice to Methven of any breach or defects in relation to those Goods (including any shortfall in or damage to the Goods).
- 6.3 If the Customer does not give notice to Methven under Condition 6.2 in respect of any Goods, the Customer will be deemed to have accepted such Goods on expiry of the seven day period from and including the date of delivery.
- 6.3.1 Legal and beneficial ownership of the Goods shall not pass to the Customer until Methven has received payment in full in cleared funds for:
- 6.3.2 all sums including any interest and any debit or credit card surcharge due in respect of the Goods; or
- 6.3.3 any other goods or services that Methven has supplied to the Customer.
- 6.4 Until title to the Goods has passed to the Customer, the Customer shall:
- 6.4.1 hold the Goods on a fiduciary basis as Methven's bailee;
- 6.4.2 store the Goods (at no cost to Methven) separately from all other goods held by the Customer so that they remain identifiable as Methven's property;
- 6.4.3 not destroy, remove, deface or obscure any identifying mark or packaging on or relating to the Goods; and
- 6.4.4 maintain the Goods in satisfactory condition and keep them insured against all risk for their full price from the date of delivery; but the Customer may resell or use the Goods in the ordinary course of its business. Any sale of Goods by the Customer pursuant to this Condition 6.4 will be a sale of the Customer's property on the Customer's own behalf and the Customer will deal as principal when making such a sale.
- 6.5 The Customer's right to possession, use and resale of the Goods will terminate immediately:
- 6.5.1 if the Customer becomes Insolvent;
- 6.5.2 on Methven giving the Customer written notice that it has any reasonable concerns regarding the financial standing of the Customer;
- 6.5.3 if the Customer fails to pay any sum due to Methven under the Contract or any other contract between Methven and the Customer on or before the due date; or
- 6.5.4 if the Customer encumbers or in any way charges any of the Goods.
- 6.6 The Customer grants Methven, its agents, employees and sub-contractors an irrevocable licence at any time to enter any premises where the Goods are or may be stored in order to inspect them, or, where the Customer's right to possession, use and resale has terminated, to recover them.
- 6.7 If the Customer's right to possession, use and resale of the Goods terminates in accordance with Condition 6.5, Methven will be entitled to issue the Customer with a credit note for all or any part of the price of the Goods together with value added tax thereon.
- 6.8 In the event that Methven has failed to deliver the Goods by the date on which the Customer received an invoice in respect of the Goods, the Customer must within seven days from and including the date on which the invoice was received by the Customer inform Methven that such Goods have not been delivered.

7. Termination

- 7.1 If the Customer:
- 7.1.1 fails to make any payment when it becomes due;
- 7.1.2 becomes Insolvent;
- 7.1.3 commits a material breach of the Contract which cannot be remedied; or
- 7.1.4 commits a material breach of the Contract which can be remedied but fails to remedy that breach within 30 days of a written notice setting out the breach and requiring it to be remedied being given by Methven, without prejudice to any other rights that Methven may have under the Contract or otherwise, Methven may (at its discretion) defer or cancel any further deliveries and/or terminate the Contract immediately by giving written notice to that effect to the Customer.
- 7.2 A material breach can be remedied if the Customer can comply with the relevant obligation in all respects other than as to time of performance unless time of performance of such obligation is of the essence.
- 7.3 Following expiry or termination of the Contract:
- 7.3.1 Methven will be entitled to invoice all Prices and any insurance, carriage and delivery costs incurred which have not yet been invoiced; and
- 7.3.2 all invoices (including any invoices issued under Condition 7.3.1) will become immediately due and payable by the Customer.
- 7.3.3 Conditions 1, 2, 6, 7.3, 8, 9, 10 and 12 will continue in force, together with any other Conditions which expressly or impliedly continue to have effect after expiry or termination of the Contract; and
- 7.3.4 all other rights and obligations will immediately cease without prejudice to any rights, obligations, claims (including claims for damages for breach) and liabilities which have accrued prior to the date of expiry or termination.
- 7.4 Methven will be entitled to suspend any deliveries otherwise due to occur following service of a notice specifying a breach under Condition 7.1.4, until either the breach is remedied (if applicable) or the Contract terminates, whichever occurs first.
- 7.5 Subject to Condition 5.2, cancellation and/or deferment of any Order by the Customer will only be accepted (at Methven's sole discretion) by Methven issuing express written approval of such cancellation and/or deferment to the Customer and in any case on condition that any costs or expenses incurred by Methven up to the date of cancellation and/or deferment and all loss, costs and/or other liabilities resulting to Methven by reason of such cancellation and/or deferment will be immediately (on request by Methven) reimbursed by the Customer to Methven.

8. Warranty

- 8.1 Methven will, free of charge, within a period of 12 months from the date of delivery of Goods which are proved to the reasonable satisfaction of Methven to not comply with specification due to defects in materials, workmanship and/or design (other than a design made, furnished or specified by the Customer), repair, or at its option replace, such Goods. This obligation will not apply where:
- 8.1.1 any instructions as to storage of the Goods have not been complied with in all respects or the Goods have been otherwise incorrectly stored; or
- 8.1.2 the Customer has failed to notify Methven of any defect or suspected defect within 7 days of the delivery where the defect should be apparent on reasonable inspection, or within 7 days of the same coming to the knowledge of the Customer where the defect is not one which should be apparent on reasonable inspection, and in any event no later than 12 (twelve) months from the date of delivery.
- 8.2 Methven will arrange for any such defective or damaged Goods to be collected and will deliver any replacement Goods to the Customer at Methven's own expense. If Methven or its carrier is unable to collect the Goods on the date proposed by the carrier due to any act or omission by the Customer then an administration fee of £15.00 will be payable by the Customer (which Methven may deduct from any sums refunded to the Customer).
- 8.3 Any Goods which have been replaced will belong to Methven. Any repaired or replacement Goods will be liable to repair or replacement under the terms specified in Condition 8.1 for the unexpired portion of the 12 month period from the original date of delivery of the replaced Goods.
- 8.4 Subject to Condition 9.5 the Customer's sole remedy and Methven's entire liability in respect of (i) Goods which do not comply with specification due to defects in materials, workmanship and/or design; and/or (ii) Goods which are otherwise defective, shall be as set out in this Condition 8.

10. Return of Goods

- 10.1 No return of Goods will be accepted by Methven without prior authorisation and a return order number being issued by Methven.
- 10.2 In the event the Customer returns any Goods which are not defective, such Goods will be accepted by Methven only if they are returned to Methven in an undamaged resalable condition which requires that the Goods are unused and contained within their original undamaged packaging, and only if:
- 10.2.1 after Methven has inspected such Goods, Methven reasonably considers that the Goods are in a condition which is no worse than the condition in which the Goods were delivered to the Customer; and
- 10.2.2 the Customer has returned the relevant Goods to Methven within 30 days following the date on which the Goods were delivered to the Customer.
- 10.3 In the event that the Customer wishes to return non-defective Goods to Methven following the expiry of the 30 day period set out in Condition 10.2.2 above, Methven will have absolute sole discretion as to whether it shall offer a refund to the Customer in respect of such Goods.
- 10.4 In relation to any returns made:
- 10.4.1 under Condition 10.2, Methven will deduct 25% of the aggregate of the Price plus any surcharge paid under Condition 4.5 for the relevant Goods; and
- 10.4.2 under Condition 10.3 above, Methven will deduct a discretionary restocking fee (which may exceed 25% of the aggregate of the Price plus any surcharge paid under Condition 4.5 for the relevant Goods), plus the cost of carriage, from the sums refunded to the Customer in order to cover Methven's administration and restocking costs.
- 10.5 Subject to clause 8, Methven will not accept any return of (or issue any refund or credit in respect of) non-faulty Goods more than 90 days following the delivery date.
- 10.6 If Methven receives any returned Goods or other products which:

10.6.1 have not been given prior authorisation for return in accordance with Condition 10.1;

10.6.2 have been returned as defective but which, upon inspection by Methven, are found not to be defective; and/or

10.6.3 are received by Methven more than 90 days following the delivery date,

Methven will be entitled but not obliged to return such Goods to the Customer at the Customer's cost and charge to the Customer a £15 (plus VAT) handling fee.

10.7 Methven shall be under no obligation to accept the return of or provide a refund in respect of any Goods ordered to the Customer's Specification except insofar as such Goods are defective in which case Condition 8 shall apply.

10.8 If a return of Goods has been agreed by Methven, it will arrange a collection date with its carrier. If Methven or its carrier is unable to collect the Goods on the date proposed by the carrier due to any act or omission by the Customer then an administration fee of £15.00 will be payable by the Customer (which Methven may deduct from any sums refunded to the Customer).

11. Force Majeure

11.1 Methven will not be in breach of the Contract or otherwise liable to the Customer for any failure to perform or delay in performing its obligations under the Contract to the extent that such failure or delay is due to a Force Majeure Event. The Customer will continue to pay the prices for any Goods which Methven continues to supply notwithstanding the occurrence of the Force Majeure Event.

11.2 If Methven is unable to deliver or the Customer is unable to take delivery of a material part of the Goods for a period of more than 14 days due to a Force Majeure Event which gives rise to relief from liability under Condition 11.1, Methven will be entitled to terminate the Contract immediately by giving written notice to that effect to the Customer.

12. Miscellaneous

- 12.1 Time will not be of the essence in respect of any obligation with which Methven is required to comply under the Contract.
- 12.2 Methven's rights and remedies set out in the Conditions are in addition to and not exclusive of any rights and remedies provided by law.
- 12.3 If any term of the Contract is found by any court or body of authority of competent jurisdiction to be illegal, unlawful, void or unenforceable, such term will be deemed to be severed from the Contract and this will not affect the remainder of the Contract which will continue in full force and effect.
- 12.4 A delay in exercising or failure to exercise a right or remedy under or in connection with the Contract will not constitute a waiver of, or prevent or restrict future exercise of, that or any other right or remedy, nor will the single or partial exercise of a right or remedy prevent or restrict the further exercise of that or any other right or remedy. A waiver of any right, remedy, breach or default will only be valid if it is in writing and signed by the party giving it and only in the circumstances and for the purpose for which it was given and will not constitute a waiver of any other right, remedy, breach or default.
- 12.5 The Customer will not be entitled to assign, transfer, charge, hold on trust for any person or deal in any other manner with any of its rights under the Contract or to sub-contract any of its obligations under the Contract.
- 12.6 Methven will be entitled to assign, transfer, charge, hold on trust for any person and deal in any other manner with any of its rights under the Contract and to sub-contract any of its obligations under the Contract.
- 12.7 The parties do not intend that any term of the Contract will be enforceable under the Contracts (Rights of Third Parties) Act 1999 by any person other than the parties.
- 12.8 The Contract constitutes the entire agreement between the parties and supersedes any prior agreement or arrangement in respect of its subject matter and:
- 12.8.1 neither party has entered into the Contract in reliance upon, and it will have no remedy in respect of, any misrepresentation, representation or statement (whether made by the other party or any other person) which is not expressly set out in the Contract;
- 12.8.2 the only remedies available for any misrepresentation or breach of any representation or statement which was made prior to entry into the Contract and which is expressly set out in the Contract will be for breach of contract; and
- 12.8.3 nothing in this Condition 12.8 will be interpreted or construed as limiting or excluding the liability of any person for fraud or fraudulent misrepresentation.
- 12.9 Any notice or other communication required to be given to a party under or in connection with this contract shall be in writing and shall be delivered by hand or sent by pre-paid first-class post or other next working day postal delivery service, at its registered office (if a company) or (in any other case) its principal place of business.
- 12.10 Any notice or communication shall be deemed to have been received if delivered by hand, on a signature of a delivery receipt, or otherwise at 9.00 am on the second Business Day after posting or at the time recorded by the delivery service.
- 12.11 Conditions 12.9 and 12.10 do not apply to the service of any proceedings or other documents in any legal action to which the Civil Procedure Rules apply.
- 12.12 The Contract and any non-contractual obligations arising out of or in connection with it will be governed by English law.
- 12.13 Each party agrees that the courts of England and Wales have exclusive jurisdiction to determine any dispute arising out of or in connection with the Contract (including in relation to any non-contractual obligations).
- 12.14 Either party may seek specific performance, interim or final injunctive relief or any other relief of similar nature or effect in any court of competent jurisdiction.

METHVEN

METHVEN UK LIMITED

Methven Experience Centre
3-3A Stone Cross Court
Yew Tree Way
Golborne
Warrington
United Kingdom
WA3 3JD

UK Freephone: 0800 195 1602

Tel: +44 (0)1942 680 177

Fax: +44 (0)1942 680 190

Email: sales@uk.methven.com

Web: www.methven.com

www.deva.org.uk

Please note: While every effort is made to ensure that the details in this brochure were correct at the time of printing, Methven reserves the right to alter specifications or product from that shown. This brochure is printed on an environmentally responsible paper, elemental chlorine free.



Please recycle this brochure and all packaging elements after use.

Methven encourages product recycling, please contact your local recycling centre for more details.

