

VH2

BY VANITY HALL





VANITY HALL



Welcome to VH2 BY VANITY HALL

Welcome to VH2 by Vanity Hall. A contemporary range of bathroom furniture for your home, combining a wealth of experience, quality and British manufacturing.

Boasting a comprehensive selection of sixteen door finishes and matching carcasses, with complimentary laminate and Corian worktops, VH2 is perfect for the modern bathroom.

A quality range of furniture manufactured to order. So whether you require fitted or modular, floor or wall mounted, VH2 stands out as the furniture choice for you.

We thank you for choosing VH2 by Vanity Hall and look forward to making your dream bathroom a reality.

Contents

- 4 GRAPHITE GLOSS
- 6 GLADSTONE OAK
- 8 GREY GLOSS
- 10 CREAM GLOSS
- 12 ELM
- 14 WHITE GLOSS
- 16 HIGHLAND ASH
- 18 STONE ASH
- 20 NEW ORLEANS OAK
- 22 ELM LAVA
- 24 TROJAN OAK
- 26 MALI WENGE
- 28 FINISH OPTIONS
- 34 PRICING GUIDE



ULTRA

ULTRA | Graphite Gloss

ABOVE:
WORKTOPS: N/A
HANDLES: Square Profile Chrome 320mm



ULTRA | Gladstone Oak

ABOVE:
WORKTOPS: Belmont Granite
HANDLES: Flat Curved Chrome 296mm & 96mm

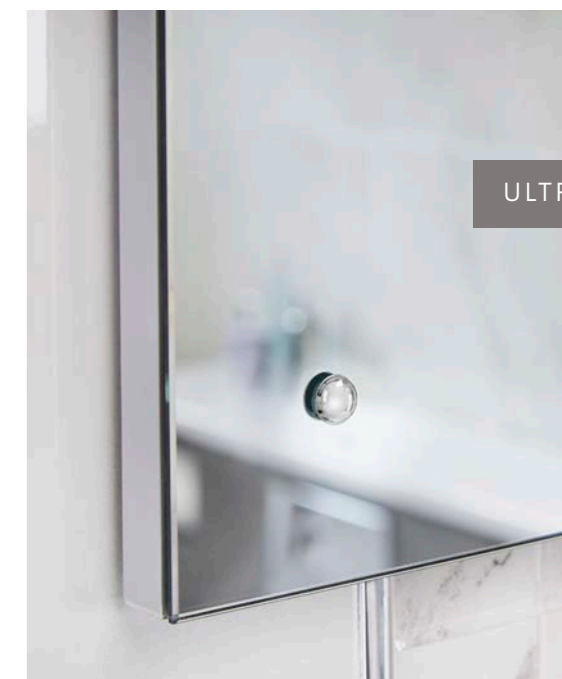

ULTRA | Grey Gloss

ABOVE:

WORKTOPS: White Andromeda
HANDLES: Blum Push To Open



ULTRA

ULTRA | Cream Gloss

ABOVE:
WORKTOPS: Sonora
HANDLES: Bar Handle Chrome 320mm



ULTRA

ULTRA | Elm

ABOVE:
 WORKTOPS: Glacier White
 HANDLES: Blum Push Drawer



ULTRA | White Gloss

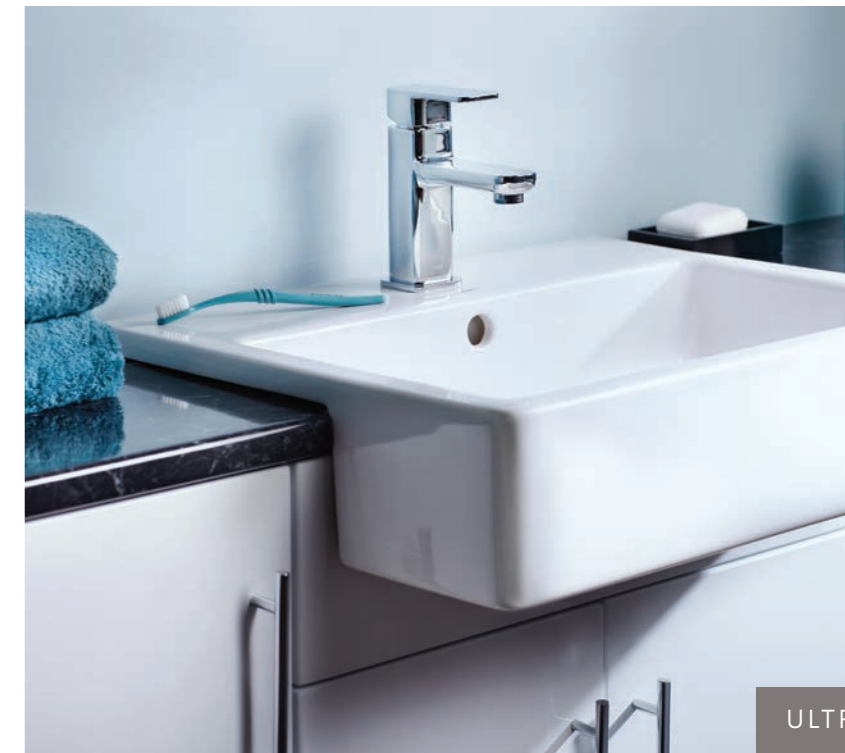

ULTRA



ABOVE:
WORKTOPS: Black Onyx Gloss
HANDLES: Quill Chrome 296mm



ULTRA

ULTRA | Highland Ash

ABOVE:
WORKTOPS: Everest
HANDLES: Straight Bar Chrome 96mm



ULTRA | Stone Ash

ABOVE:
WORKTOPS: Glacier White
HANDLES: Bar Handle Chrome 320mm & 96mm



ULTRA | New Orleans Oak

ABOVE:
WORKTOPS: Sonora
HANDLES: Straight Bar Nickel 360mm & 96mm



ULTRA

ULTRA | Elm Lava

ABOVE:
WORKTOPS: Glacier White
HANDLES: Blum Push Drawer



ULTRA

ULTRA | Trojan Oak

ABOVE:
WORKTOPS: Tuscan Granite
HANDLES: Straight Bar Chrome 96mm.



ULTRA

ULTRA | Mali Wenge

ABOVE:
WORKTOPS: Glacier White
HANDLES: Angled Pull Chrome 32mm

VH2
BY VANITY HALL

FINISH OPTIONS

DOOR FINISHES | ULTRA



WHITE GLOSS



CREAM GLOSS



GRAPHITE GLOSS



GREY GLOSS



WHITE



CREAM



GRAPHITE



GREY



HIGHLAND ASH



STONE ASH



ELM



ELM LAVA



MALI WENGE



TROJAN OAK



NEW ORLEANS OAK

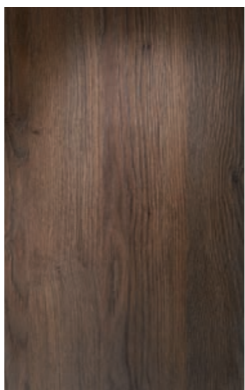

GLADSTONE OAK

DOOR HANDLES & KNOBS



BAR HANDLE CHROME - TWO SIZE OPTIONS: 320mm [C] & 96mm [C]



SQUARE PROFILE HANDLE CHROME TWO SIZE OPTIONS: 320mm [C] & 96mm [C]



STRAIGHT BAR NICKEL - TWO SIZE OPTIONS: 360mm [C] & 96mm [C]



FLAT CURVED CHROME - TWO SIZE OPTIONS: 296mm [C] & 96mm [C]



QUILL CHROME - TWO SIZE OPTIONS: 296mm [C] & 96mm [C]



BOW CHROME - TWO SIZE OPTIONS: 288mm [C] & 96mm [C]



CURVED CHROME DIMPLE - 96mm [C]



STRAIGHT BAR CHROME - 96mm [C]



CURVED CHROME - 96mm [C]



CURVED S CHROME - 96mm [C]



QUATTRO CHROME - 96mm [C]



BUICK PULL NICKEL - 64mm [C]

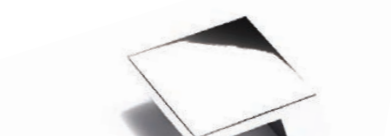

ANGLED PULL CHROME - 32mm [C]



WHITE



CHROME



DIMPLE CHROME

FINISHES | LAMINATE

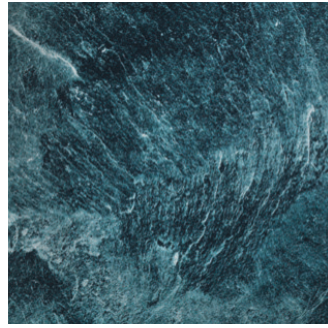

WELSH SLATE

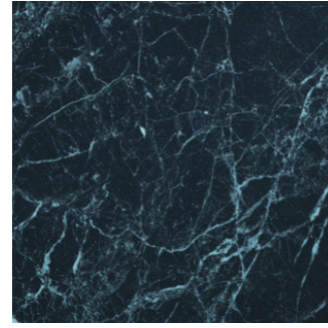

BLACK ONYX GLOSS

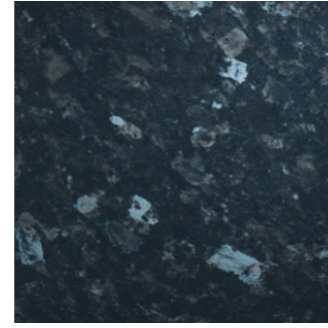

EVEREST



TUSCAN GRANITE



BLACK ANDROMEDA

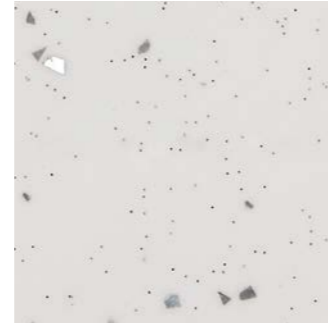

WHITE ANDROMEDA



WHITE CRYSTAL

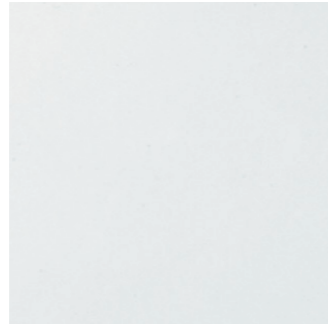

WHITE GLOSS



ARCTIC GLOSS

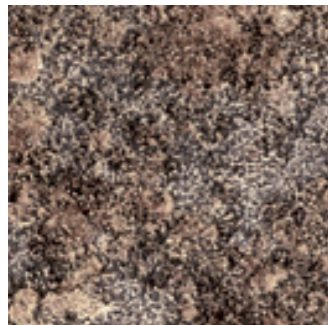

MINERAL TERRA



BELMONT GRANITE

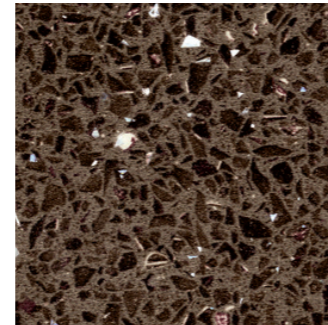

TAWNY CRYSTAL

CORIAN | CLASSIC



DESIGNER WHITE



GLACIER WHITE



EVEREST



AURORA



DUSK



MIDNIGHT



DEEP BLACK QUARTZ

***PLEASE NOTE:**
We are able to produce worktops in any colour from the Corian range. Please contact us for a quotation on any alternative finishes to the samples shown.

CORIAN | PRESTIGE



LAVA ROCK*



SONORA*



CLAM SHELL*



SILVER BIRCH



SAGE BRUSH*



ANTARCTICA



SAVANNAH



MATTERHORN



SANDSTONE



COCOA BROWN



CANYON

***PLEASE NOTE:**
These colours represent a stone appearance and can have vein and pattern detail that is variable from samples shown.

DuPont™
CORIAN®

Quality Network
INDUSTRIAL PARTNER
DuPont™ Corian®





Vanity Hall is proud to be a partner of the DuPont Corian® Quality Network. An initiative put together to support elite fabricators of the world's leading solid surface products. As well as manufacturing bathroom worktops, we are able to offer a supply and fit service for many other applications, including kitchen worktops and bath surrounds. Please feel free to contact us and discuss this service further.



VH2
BY VANITY HALL













PRICING GUIDE

VANITY HALL DOOR FINISHES						
PRODUCT	SIZE mm	£		PRODUCT	SIZE mm	£
BASIN UNIT WITH SHELF. (Back Rail Is Raised To allow access for pipework. 825mm Height Including Plinth)				WALL HUNG WC UNIT.		
FB500R FB600R FB700R FB800R	500 x 200 x 825 600 x 200 x 825 700 x 200 x 825 800 x 200 x 825	342 349 371 392		FWCWH500R FWCWH600R FWCWH700R FWCWH800R	500 x 200 x 825 600 x 200 x 825 700 x 200 x 825 800 x 200 x 825	374 387 403 423
FB500 FB600 FB700 FB800	500 x 344 x 825 600 x 344 x 825 700 x 344 x 825 800 x 344 x 825	342 349 371 392		FWCWH500 FWCWH600 FWCWH700 FWCWH800	500 x 344 x 825 600 x 344 x 825 700 x 344 x 825 800 x 344 x 825	374 387 403 423
FB500L FB600L FB700L FB800L	500 x 525 x 825 600 x 525 x 825 700 x 525 x 825 800 x 525 x 825	355 365 385 405		WALL HUNG WC UNIT WITH TOP FASCIA.		
BASIN UNIT WITH SHELF C/W DURAVIT DURASTYLE 550MM SINGLE TAP HOLE BASIN (Top fascia Is Supplied Cut And Edged. Back Rail Is Raised To Allow For Pipework. 825mm Height Including Plinth)				FWCWHT500R FWCWHT600R FWCWHT700R FWCWHT800R	500 x 200 x 825 600 x 200 x 825 700 x 200 x 825 800 x 200 x 825	374 387 403 423
FB600DU FB700DU FB800DU	600 x 344 x 825 700 x 344 x 825 800 x 344 x 825	617 639 660		FWCWHT500 FWCWHT600 FWCWHT700 FWCWHT800	500 x 344 x 825 600 x 344 x 825 700 x 344 x 825 800 x 344 x 825	374 387 403 423
BASIN UNIT WITH TWO DRAWERS. (Open Back To allow access For pipework. 825mm Height Including Plinth)				WC UNIT COMPLETE WITH VANTAGE CONCEALED CISTERN AND PUSH BUTTON (Fronts Are Clipped On For Easy Removal During Installation or Maintenance. 825mm Height Including Plinth)		
FB2D600 FB2D700 FB2D800	600 x 344 x 825 700 x 344 x 825 800 x 344 x 825	583 628 674		FWC500RC FWC600RC FWC700RC FWC800RC	500 x 200 x 825 600 x 200 x 825 700 x 200 x 825 800 x 200 x 825	482 499 511 523
FB2D600L FB2D700L FB2D800L	600 x 525 x 825 700 x 525 x 825 800 x 525 x 825	613 658 704	FWC500C FWC600C FWC700C FWC800C	500 x 344 x 825 600 x 344 x 825 700 x 344 x 825 800 x 344 x 825	482 499 511 523	
BASIN UNIT WITH TWO DRAWERS C/W DURAVIT DURASTYLE 550MM SINGLE TAP HOLE BASIN. (Top Fascia Is Supplied Cut And Edged. Open Back To Allow For Pipework. 825mm Height Including Plinth)				WC UNIT C/W DURASTYLE PAN AND SOFT CLOSE SEAT, VANTAGE CONCEALED CISTERN AND PUSH BUTTON (Bottom Fascia Is Supplied Cut And Edged. 825mm Height Including Plinth)		
FB2D600DU FB2D700DU FB2D800DU	600 x 344 x 825 700 x 344 x 825 800 x 344 x 825	851 896 942		FWC500RCDU FWC600RCDU FWC700RCDU FWC800RCDU	500 x 200 x 825 600 x 200 x 825 700 x 200 x 825 800 x 200 x 825	883 900 913 924
FB2D600L FB2D700L FB2D800L	600 x 525 x 825 700 x 525 x 825 800 x 525 x 825	613 658 704	FWC500CDU FWC600CDU FWC700CDU FWC800CDU	500 x 344 x 825 600 x 344 x 825 700 x 344 x 825 800 x 344 x 825	883 900 913 924	
WC UNIT FOR CONCEALED CISTERN OR BATH END (Fronts Are Clipped On For Easy Removal During Installation or Maintenance. 825mm Height Including Plinth)				WALL HUNG WC UNIT, INCLUDES ILLUSION COMPACT FRAME, CISTERN AND OYSTER FLUSH PLATE. (Fronts Are Clipped On For Easy Removal During Installation or Maintenance).		
FWC500R FWC600R FWC700R FWC800R	500 x 200 x 825 600 x 200 x 825 700 x 200 x 825 800 x 200 x 825	283 299 311 326		FWCWH500RC FWCWH600RC FWCWH700RC FWCWH800RC	500 x 200 x 825 600 x 200 x 825 700 x 200 x 825 800 x 200 x 825	716 731 745 757
FWC500 FWC600 FWC700 FWC800	500 x 344 x 825 600 x 344 x 825 700 x 344 x 825 800 x 344 x 825	283 299 311 326	FWCWH500C FWCWH600C FWCWH700C FWCWH800C	500 x 344 x 825 600 x 344 x 825 700 x 344 x 825 800 x 344 x 825	716 731 745 757	

VANITY HALL DOOR FINISHES						
PRODUCT	SIZE mm	£		PRODUCT	SIZE mm	£
WALL HUNG WC UNIT C/W DURAVIT DURASTYLE PAN, SOFT CLOSE SEAT, ILLUSION COMPACT FRAME, CISTERN AND OYSTER FLUSH PLATE. (Fascia Is Supplied Cut And Edged, Fronts are clipped on for easy removal for installation and maintenance).				DOUBLE BASE UNIT WITH SHELF. (825mm Height Including plinth).		
FWCWH500RCDU FWCWH600RCDU FWCWH700RCDU FWCWH800RCDU	500 x 200 x 825 600 x 200 x 825 700 x 200 x 825 800 x 200 x 825	1155 1170 1184 1196		FDD500R FDD600R FDD700R FDD800R	500 x 200 x 825 600 x 200 x 825 700 x 200 x 825 800 x 200 x 825	325 343 358 365
FWCWH500CDU FWCWH600CDU FWCWH700CDU FWCWH800CDU	500 x 344 x 825 600 x 344 x 825 700 x 344 x 825 800 x 344 x 825	1155 1170 1184 1196	FDD500 FDD600 FDD700 FDD800	500 x 344 x 825 600 x 344 x 825 700 x 344 x 825 800 x 344 x 825	325 343 358 365	
WALL HUNG WC UNIT WITH TOP FASCIA, INCLUDES ILLUSION COMPACT FRAME, CISTERN AND OYSTER FLUSH PLATE. Fronts are clipped on for easy removal for installation and maintenance).				THREE DRAWER UNIT. Please Note: Top Drawer is 160mm High. Remaining Drawers are 240mm High. (825mm Height Including plinth).		
FWCWHT500RC FWCWHT600RC FWCWHT700RC FWCWHT800RC	500 x 200 x 825 600 x 200 x 825 700 x 200 x 825 800 x 200 x 825	716 731 745 757		F3D300 F3D400	300 x 344 x 825 400 x 344 x 825	366 384
FWCWHT500C FWCWHT600C FWCWHT700C FWCWHT800C	500 x 344 x 825 600 x 344 x 825 700 x 344 x 825 800 x 344 x 825	716 731 745 757	F3D300L F3D400L	300 x 525 x 825 400 x 525 x 825	385 405	
WALL HUNG WC UNIT AND TOP FASCIA C/W DURAVIT DURASTYLE PAN, SOFT CLOSE SEAT, ILLUSION COMPACT FRAME, CISTERN AND OYSTER FLUSH PLATE. (Fascia Is Supplied Cut And Edged, Fronts are clipped on for easy removal for installation and maintenance).				SINGLE DRAWER AND DOOR UNIT WITH SHELF. [Please state L/H or R/H hinged]. (825mm Height Including plinth).		
FWCWHT500RCDU FWCWHT600RCDU FWCWHT700RCDU FWCWHT800RCDU	500 x 200 x 825 600 x 200 x 825 700 x 200 x 825 800 x 200 x 825	1155 1170 1184 1196		FDD300 FDD400	300 x 344 x 825 400 x 344 x 825	307 324
FWCWHT500CDU FWCWHT600CDU FWCWHT700CDU FWCWHT800CDU	500 x 344 x 825 600 x 344 x 825 700 x 344 x 825 800 x 344 x 825	1155 1170 1184 1196	FDD300L FDD400L	300 x 525 x 825 400 x 525 x 825	325 340	
SINGLE DOOR UNIT WITH SHELF. [Please state L/H or R/H hinged]. (825mm Height Including plinth).				LINEN BASKET UNIT WITH PULL DOWN DOOR. (825mm Height Including plinth).		
FTRU200R FTRU200	200 x 200 x 825 200 x 344 x 825	231 231		FLB300 FLB400	300 x 344 x 825 400 x 344 x 825	316 346
FSD165R FSD200R FSD250R FSD300R FSD400R	165 x 200 x 825 200 x 200 x 825 250 x 200 x 825 300 x 200 x 825 400 x 200 x 825	170 200 200 231 246	FLB300L FLB400L	300 x 525 x 825 400 x 525 x 825	330 365	
FSD165 FSD200 FSD250 FSD300 FSD400	165 x 344 x 825 200 x 344 x 825 250 x 344 x 825 300 x 344 x 825 400 x 344 x 825	170 200 200 231 246	OPEN SHELF UNIT. (825mm Height Including plinth).			
FSD165L FSD200L FSD250L FSD300L FSD400L	165 x 525 x 825 200 x 525 x 825 250 x 525 x 825 300 x 525 x 825 400 x 525 x 825	175 205 205 240 255	FOS200R FOS300R FOS400R	200 x 180 x 825 300 x 180 x 825 400 x 180 x 825	117 124 134	
			FOS200 FOS300 FOS400	200 x 323 x 825 300 x 323 x 825 400 x 323 x 825	117 124 134	
			FOS200L FOS300L FOS400L	200 x 505 x 825 300 x 505 x 825 400 x 505 x 825	125 135 145	













VANITY HALL DOOR FINISHES

PRODUCT	SIZE mm	£	PRODUCT	SIZE mm	£
 <p>SINGLE DOOR WALL CABINET WITH TWO GLASS SHELVES. [Please state L/H or R/H hinged].</p>			 <p>SINGLE DOOR DOUBLE SIDED MIRROR WALL CABINET WITH TWO GLASS SHELVES. (Door Is handleless and opens Underneath)</p>		
FSDC165 FSDC200 FSDC250 FSDC300 FSDC400	165 x 200 x 640 200 x 200 x 640 250 x 200 x 640 300 x 200 x 640 400 x 200 x 640	195 195 205 222 239	MSWC300 MSWC400	300 x 150 x 640 400 x 150 x 640	248 263
 <p>SINGLE DOOR FRAMED MIRROR WALL CABINET WITH TWO GLASS SHELVES. [Please state L/H or R/H hinged].</p>			 <p>DOUBLE DOOR DOUBLE SIDED MIRROR WALL CABINET WITH TWO GLASS SHELVES. (Door Is handleless and opens Underneath)</p>		
FSDCM300 FSDCM400	300 x 200 x 640 400 x 200 x 640	289 304	MDWC600 MDWC700 MDWC800	600 x 150 x 640 700 x 150 x 640 800 x 150 x 640	408 422 437
 <p>SINGLE DOOR DOUBLE SIDED MIRROR WALL CABINET WITH TWO GLASS SHELVES. [Please state L/H or R/H hinged].</p>			 <p>TRIPLE DOOR DOUBLE SIDED MIRROR WALL CABINET WITH TWO GLASS SHELVES. (Door Is handleless and opens Underneath)</p>		
FSMC165 FSMC300 FSMC400	165 x 200 x 640 300 x 200 x 640 400 x 200 x 640	240 247 262	MDWC1000 MDWC1200	1000 x 150 x 640 1200 x 150 x 640	625 645
 <p>DOUBLE WALL CABINET WITH TWO GLASS SHELVES.</p>			 <p>SINGLE DOOR CABINET WITH TWO GLASS SHELVES. (Please State L/H Or R/H Hinge. Unit Is Designed To Sit On Worktop).</p>		
FDWC500 FDWC600 FDWC700 FDWC800	500 x 200 x 640 600 x 200 x 640 700 x 200 x 640 800 x 200 x 640	260 270 284 302	FSTC165 FSTC300 FSTC400	165 x 200 x 1148 300 x 200 x 1148 400 x 200 x 1148	270 280 295
 <p>DOUBLE DOOR FRAMED MIRROR WALL CABINET WITH TWO GLASS SHELVES</p>			 <p>TWO DOOR TALL UNIT WITH OPEN SHELVING. (Please State L/H Or R/H Hinge). 1998mm Overall Height If Installed With Plinth.</p>		
FDWCM600 FDWCM700 FDWCM800	600 x 200 x 640 700 x 200 x 640 800 x 200 x 640	408 421 437	FTC300 FTC400	300 x 344 x 1816 400 x 344 x 1816	430 453
 <p>DOUBLE DOOR DOUBLE SIDED MIRROR WALL CABINET WITH TWO GLASS SHELVES</p>					
FDMC600 FDMC700 FDMC800	600 x 200 x 240 700 x 200 x 240 800 x 200 x 240	408 421 437			

VANITY HALL DOOR FINISHES





PRODUCT	SIZE mm	£	PRODUCT	SIZE mm	£
 <p>TALL UNIT WITH TOP DOOR, OPENING SHELVING AND PULL DOWN LINEN BASKET. (Please State L/H Or R/H Hinge). 1998mm Overall Height If Installed With Plinth.</p>			 <p>INFILL PANELS MADE TO MATCH CARCASS FINISH. [Prices charged to nearest 100mm].</p>		
FTCLB300 FTCLB400	300 x 344 x 1816 400 x 344 x 1816	479 499	FIP643	643 x Width	12
 <p>TWO DOOR TALL UNIT WITH THREE WOODEN SHELVES. (Please State L/H Or R/H Hinge). 1998mm Overall Height If Installed With Plinth. 2 Fixed Shelves In Top Unit. 1 Fixed Shelf In Bottom Unit.</p>			 <p>CORNER POST - SAME FINISH AS CARCASS.</p>		
FFHTC300 FFHTC400	300 x 344 x 1816 400 x 344 x 1816	459 479	FCP643	70 x 70 x 643	22
 <p>SINGLE DOOR TALL UNIT. (Please State L/H Or R/H Hinge. Wall Mounted Only) 1 x Fixed Centre Shelf. 2 x Removable Shelves.</p>			 <p>FRAMED MIRROR.</p>		
MFHTC300 MFHTC400	300 x 344 x 1655 400 x 344 x 1655	459 479	FM600S FM700S FM800S FM1200S FM600 FM700 FM800	600 x 640 700 x 640 800 x 640 1200 x 640 600 x 948 700 x 948 800 x 948	188 202 216 294 218 232 247
 <p>FLYOVER SHELVING SOFFIT. (Price Per 1000mm) Price per 1000mm. Please Note: Maximum Length is 2400mm.</p>			 <p>POLISHED MIRROR. (Mirror Is Mounted Onto Matching Caracass Colour Board)</p>		
FSS200 FSS350	200mm 350mm	39 52	PEM600S PEM700S PEM800S PEM600 PEM700 PEM800	600 x 640 700 x 640 800 x 640 600 x 1098 700 x 1098 800 x 1098	165 175 185 183 192 208
			 <p>TWO SPOTLIGHTS FOR SOFFIT SURFACE MOUNTED. (Includes One Transformer)</p>		
			 <p>TWO SPOTLIGHTS FOR SOFFIT RECESSED. (Includes One Transformer)</p>		
			SLS		105
			SLR		105

VANITY HALL DOOR FINISHES					
PRODUCT	SIZE mm	£	PRODUCT	SIZE mm	£
	DOUBLE DOOR AND SIX DRAWERS UNIT WITH DURAVIT VERO SLAB BOWL. SINGLE TAP HOLE			DOUBLE DOOR UNIT WITH DURAVIT DARLING NEW SLAB BOWL. SINGLE TAP HOLE.	
	MSBV1 1250 MSBV1 1050	1250 x 490 x 610 1050 x 490 x 610		1826 1789	MSBD1 1630 MSBD1 1830 MSBD1 1030
	DOUBLE DRAWER AND TWO SINGLE DOORS UNIT WITH DURAVIT VERO SLAB BOWL. SINGLE TAP HOLE			SINGLE DRAWER UNIT WITH DURAVIT DARLING NEW SLAB BOWL. SINGLE TAP HOLE.	
	MSBV2 1250 MSBV2 1050	1250 x 490 x 610 1050 x 490 x 610		1614 1578	MSBD2 630 MSBD2 830 MSBD2 1030
	DOUBLE DOOR AND FOUR DRAWERS UNIT WITH DURAVIT VERO SLAB BOWL. SINGLE TAP HOLE			DOUBLE DRAWER UNIT WITH DURAVIT DARLING NEW SLAB BOWL. SINGLE TAP HOLE.	
	MSBV3 1250 MSBV3 1050	1250 x 490 x 610 1050 x 490 x 610		1997 1962	MSBD3 630 MSBD3 830 MSBD3 1030
	DOUBLE DRAWER UNIT WITH DURAVIT VERO SLAB BOWL. SINGLE TAP HOLE			DOUBLE DOOR UNIT WITH WHITE CORIAN BOWL.	
	MSBV4 850 MSBV4 600	850 x 490 x 610 600 x 470 x 610		1020 927	MSBC1 630 MSBC1 830 MSBC1 1030
	DOUBLE DOOR UNIT WITH DURAVIT VERO SLAB BOWL. SINGLE TAP HOLE			SINGLE DRAWER UNIT WITH WHITE CORIAN BOWL.	
	MSBV5 850 MSBV5 600	850 x 490 x 610 600 x 470 x 610		836 737	MSBC2 630 MSBC2 830 MSBC2 1030
	SINGLE DRAWER UNIT WITH DURAVIT VERO SLAB BOWL. SINGLE TAP HOLE			DOUBLE DRAWER UNIT WITH WHITE CORIAN BOWL.	
	MSBV6 850 MSBV6 600	850 x 490 x 610 600 x 470 x 610		1010 917	MSBC3 630 MSBC3 830 MSBC3 1030
	SINGLE DOOR UNIT WITH DURAVIT VERO SLAB BOWL. SINGLE TAP HOLE (Please State L/H or R/H Hinge. Tap Hole is situated on the hinged side of cabinet).			DOUBLE DRAWER UNIT WITH WHITE CORIAN BOWL.	
	MSBV7 500	500 x 250 x 610		503	

VANITY HALL DOOR FINISHES						
PRODUCT	SIZE mm	£	PRODUCT	SIZE mm	£	
	DOUBLE DOOR UNIT WITH ALDINA RESIN BOWL. SINGLE TAP HOLE.			DOUBLE BASE UNIT WITH SHELF. (664mm Overall Height If Installed With Plinth)		
	MSBA1 610 MSBA1 810	610 x 464 x 482 810 x 464 x 482		525 588	CDD600R CDD700R CDD800R	600 x 525 x 482 700 x 525 x 482 800 x 525 x 482
	SINGLE DRAWER UNIT WITH ALDINA RESIN BOWL. SINGLE TAP HOLE.			DOUBLE DRAWER UNIT WITH CUT-OUT IN TOP DRAWER. (664mm Overall Height If Installed With Plinth)		
	MSBA2 610 MSBA2 810	610 x 464 x 482 810 x 464 x 482		669 741	CDWB600R CDWB700R CDWB800R	600 x 525 x 482 700 x 525 x 482 800 x 525 x 482
	DOUBLE DRAWER UNIT WITH ALDINA RESIN BOWL. SINGLE TAP HOLE.			SINGLE DRAWER FRONT WASH BASIN UNIT. (664mm Overall Height If Installed With Plinth)		
	MSBA3 610 MSBA3 810	610 x 464 x 482 810 x 464 x 482		711 782	CDWB600RD CDWB700RD CDWB800RD	600 x 344 x 482 700 x 344 x 482 800 x 344 x 482
	DOUBLE DOOR UNIT WITH 001 RESIN BOWL. SINGLE TAP HOLE.			DOUBLE DRAWER STORAGE UNIT. (664mm Overall Height If Installed With Plinth)		
	MSB01 610 MSB01 810 MSB01 1010	610 x 460 x 482 810 x 460 x 482 1010 x 460 x 482		516 571 705	CSDWB600R CSDWB700R CSDWB800R	600 x 525 x 240 700 x 525 x 240 800 x 525 x 240
	SINGLE DRAWER UNIT WITH 001 RESIN BOWL. SINGLE TAP HOLE.			SINGLE DRAWER FRONT WASH BASIN UNIT WITH CUT-OUT.		
	MSB02 610 MSB02 810 MSB02 1010	610 x 460 x 482 810 x 460 x 482 1010 x 460 x 482		660 724 895	C2D600R C2D700R C2D800R	600 x 525 x 482 700 x 525 x 482 800 x 525 x 482
	DOUBLE DRAWER UNIT WITH 001 RESIN BOWL. SINGLE TAP HOLE.			SINGLE DRAWER FRONT WASH BASIN UNIT WITH CUT-OUT.		
	MSB03 610 MSB03 810 MSB03 1010	610 x 460 x 482 810 x 460 x 482 1010 x 460 x 482		702 765 945	CSDWBH600R CSDWBH700R CSDWBH800R	600 x 525 x 240 700 x 525 x 240 800 x 525 x 240
				CSDWBH600RD CSDWBH700RD CSDWBH800RD	600 x 344 x 240 700 x 344 x 240 800 x 344 x 240	387 394 405

Please specify the length required and it will be supplied edged at both ends. [Prices charged to the nearest 100mm above.]

VANITY HALL DOOR FINISHES

PRODUCT	SIZE mm	£	PRODUCT	SIZE mm	£
 <p>SINGLE DOOR UNIT WITH SHELF. (664mm Overall Height If Installed With Plinth. Please State L/H Or R/H Hinge)</p>			 <p>OPEN SHELF UNIT. (664mm Overall Height If Installed With Plinth)</p>		
CSD300R CSD400R	300 x 525 x 482 400 x 525 x 482	199 215	COS200R COS300R COS400R	200 x 505 x 482 200 x 505 x 482 400 x 505 x 482	107 114 124
CSD300RD CSD400RD	300 x 344 x 482 400 x 344 x 482	199 215	COS200RD COS300RD COS400RD	200 x 323 x 482 300 x 323 x 482 400 x 323 x 482	107 114 124
 <p>TWO DRAWER UNIT. (664mm Overall Height If Installed With Plinth)</p>			 <p>CONTEMPORARY UNIT ENDS.</p>		
C2D300R C2D400R	300 x 525 x 482 400 x 525 x 482	391 415	CUE344 CUE525 CUE525R CUE1998	344 x 18 x 825 525 x 18 x 825 525 x 18 x 662 344 x 18 x 1998	31 41 43 121
C2D300RD C2D400RD	300 x 344 x 482 400 x 344 x 482	391 415			
 <p>THREE DRAWER UNIT. (664mm Overall Height If Installed With Plinth)</p>					
C3D300R C3D400R	300 x 525 x 482 400 x 525 x 482	391 415			
C3D300RD C3D400RD	300 x 344 x 482 400 x 344 x 482	391 415			

PLINTHS



BATH PANELS

PRODUCT	SIZE mm	£	PRODUCT	SIZE mm	£
Plinth only available up to 2600mm in a single length	FP	2.50	Suitable for any Vanity Hall product ranges.	BP1700 BP1800 BPE680 BPE730 BPE780	278 283 134 139 144
Each base is supplied with adjustable legs and plinth clips to be screwed onto the plinth in the appropriate position at installation.	FPR	9.60	Bath panels are 400mm high and supplied with an adjustable Plinth to allow a maximum O/A height of 575mm		

Please specify the plinth required. Plinth will be supplied edged at both ends. Prices charged to nearest 100mm.



KNOBS

HANDLES







 WHITE CHROME DIMPLE CHROME	8.00 Each 8.00 Each 8.00 Each		BAR HANDLE CHROME - 96mm 8.00 Each FLAT CURVED CHROME - 96mm 8.00 Each QUILL CHROME - 96mm 8.00 Each SQUARE PROFILE CHROME - 96mm 8.00 Each CURVED CHROME - 96mm 8.00 Each STRAIGHT BAR CHROME - 96mm 8.00 Each STRAIGHT BAR NICKEL - 96mm 8.00 Each CURVED CHROME DIMPLE - 96mm 8.00 Each CURVED S CHROME - 96mm 8.00 Each QUATTRO CHROME - 96mm 8.00 Each BOW CHROME - 96mm 8.00 Each ANGLE PULL CHROME - 32mm 8.00 Each BUICK PULL NICKEL - 64mm 8.00 Each BOW CHROME - 288mm 14.00 Each QUILL CHROME - 296mm 14.00 Each FLAT CURVED CHROME - 296mm 14.00 Each STRAIGHT BAR NICKEL - 360mm 14.00 Each BAR HANDLE CHROME - 320mm 14.00 Each SQUARE PROFILE CHROME - 320mm 14.00 Each
---	-------------------------------------	---	--

The collection of furniture is factory assembled to the highest quality. When ordering remember to specify:

1. UNIT CODE 2. DOOR FINISH 3. WORKTOP FINISH 4. HANDLES 5. THE HANDING OF DOOR/HINGE LEFT OR RIGHT [Where applicable].

SIZE mm	PRODUCT	£	DESCRIPTION	FINISHES
 210	SFTF	8.00 per 100mm	Continuous Worktop. Price per 100mm	All worktops are 28mm in thickness high density board faced with laminate. Please state exact length required.
 354	FTF	9.00 per 100mm	Continuous Worktop. Price per 100mm	
 535	VTE	13.00 per 100mm	Continuous Worktop. Price per 100mm	
Welsh Slate Black Onyx Gloss Everest Tuscan Granite Black Andromeda White Andromeda White Crystal White Gloss Arctic Gloss Mineral Terra Belmont Granite Tawny Crystal				

SOLID SURFACE BESPOKE WORKTOP

 210	SSFT	210mm DEEP	
		CLASSIC	PRESTIGE
		Price per 100mm	24.75
 210	SSVT	Price per 100mm	22.50
			26.65
		354mm DEEP	
 354	SSFT	PENCIL/SQUARE EDGE	
		CLASSIC	PRESTIGE
		Price per 100mm	24.75
 354	SSVT	Price per 100mm	22.50
			26.50
		535mm DEEP	
 535	SSFT	PENCIL/SQUARE EDGE	
		CLASSIC	PRESTIGE
		Price per 100mm	38.75
 535	SSVT	Price per 100mm	37.25
			44.25

Solid surface worktop bowl, basins and other options. White or colour combinations to match worktop.
PLEASE NOTE: The minimum worktop width chargeable is 500mm.



Semi Counter Top Basin
White - £898.00 | Colour matched - £995.00
In order to correctly quote for a worktop incorporating a semi counter top bowl, 535mm worktop prices must be used.



Integrated Basin
White - £495.00 | Colour matched - £585.00
In order to correctly quote for a worktop incorporating an integrated bowl, 535mm worktop prices must be used.



Oval Ceramic Under Counter Basin - £460.00
In order to correctly quote for a worktop incorporating an oval under counter basin 535mm worktop prices must be used.



Undermount Duravit Vero Ceramic Basin - £470.00
In order to correctly quote for a worktop incorporating an integrated bowl, 535mm worktop prices must be used.



Rectangle Trough Basin
White - £898.00 | Colour matched - £995.00
In order to correctly quote for a worktop incorporating a rectangle trough basin, 535mm worktop prices must be used.



Cut Back - £184.00 Fabricated Joint - £184.00
Please Note: When joining 2 worktops in an 'L-Shape' a fabricated joint must be used.



Plant on Upstand - £9.00 (per 100mm)
50mm High



Fabricated Upstand - £21.00 (per 100mm)
50mm High

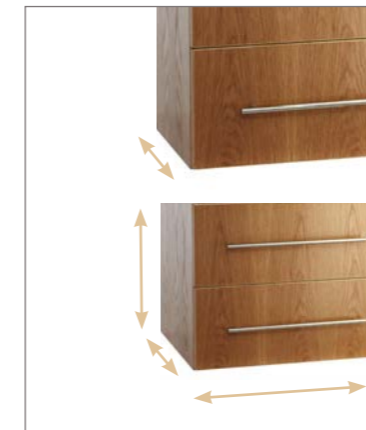

SPECIAL DEPTH PER UNIT.

PLEASE ALLOW UP TO 4 WEEKS MANUFACTURING TIME FOR THIS SERVICE

ADD 10%
PER UNIT

SPECIAL WIDTH, DEPTH & HEIGHT PER UNIT.

FOR ANYTHING OUTSIDE/LARGER THAN STANDARD WIDTH/HEIGHT
PLEASE CONTACT FOR A QUOTATION.

PLEASE ALLOW UP TO 4 WEEKS MANUFACTURING TIME FOR THIS SERVICE

ADD 20%
PER UNIT



PUSH TO OPEN HINGES (PER DOOR)



ADD £11.40 inc VAT

PUSH TO OPEN HINGES (PER DRAWER)

PLEASE NOTE: ALLOW 3MM PROJECTION FOR DRAWER FRONT FOR MECHANISM TO WORK.



ADD £13.80 inc VAT

Blum Lifetime Guarantee

All Vanity Hall Furniture is manufactured with Blum soft-close hinges and Intivo drawer boxes.

Blum components are guaranteed for the lifetime of your furniture.

*If you require any technical support for your Blum fittings please contact us on **0800 8175550***

Built for living. Guaranteed for a lifetime.

Blum UK, Mandeville Drive, Kingston, Milton Keynes MK10 0AW
Twitter: @kitchenthinkUK For full details see www.blum.com

Vanity Hall furniture & worktops are guaranteed for five years from date of purchase invoice. Within this period any fault in product that is as a result of manufacturing defect will be replaced free of charge with a matching item or nearest equivalent. Any product that is faulty due to not following the Vanity Hall aftercare requirements will be void of guarantee. Vanity Hall is not liable to cover the re-fitting cost of any products, compensation, stolen items or damage claim.

Vanity Hall furniture is only guaranteed for use in a domestic installation. Any products used in a commercial installation will be void of guarantee.

Any guarantee is limited to the original purchaser of Vanity Hall products. The guarantee is non transferrable and does not cover the cost of ex-display items.

Vanity Hall furniture has been designed and manufactured for use in general bathroom installation. It has not been designed for use in areas subject to excessive moisture and exposure to high levels of water contact. All bathroom furniture will deteriorate through prolonged periods of exposure to these situations. All bathrooms must be adequately ventilated using suitable ventilation. Failure to do this will void guarantee. Products that are installed with direct contact to high levels of water will also void guarantee.

The installation of Vanity Hall Furniture & worktops should be in full accordance to our fitting instructions (these are available via our website). Any instance of a fault in the fitting of Vanity Hall products that is due to not following these instructions will result in a void of guarantee.

A waterproof sealant must be used to protect any raw edges on furniture that has been cut to suit a basin or pipe work. Failure to do this will void guarantee.

We strongly recommend that Vanity Hall furniture is not installed in direct sunlight. Continued exposure to direct sunlight may cause door and drawer fronts to discolour.

Please try to wipe all excess moisture from Vanity Hall furniture to increase longevity and reduce the risk of water stains over a period of time.

Vanity Hall recommends the use of a duster or damp (not wet) cloth to clean our furniture and worktops. The use of furniture polish or strong cleaning products is likely to remove protective surfaces and void guarantee.

Vanity Hall have are part of the Du Pont Corian Quality Network partnership. Should you require any restoration to your solid surface worktop Vanity Hall are able to offer care & maintenance products and aftercare services.

All Vanity Hall products are manufactured to order. Any items that are returned to Vanity Hall will be subject to a 25% re-stocking fee. All items must be in a re-saleable condition and are only accepted for return within 4 weeks of delivery to retailer. Any bespoke items are non- returnable.

Sanitaryware supplied by Vanity Hall is subject to a 2% dimensional tolerance. Any items that are outside of this will be replaced free of charge. Installation must include all fittings supplied and follow the instructions provided. Failure to do this will void guarantee.

All concealed cisterns and WC frames supplied by Vanity Hall are covered by a two year guarantee from Thomas Dudley. Installation must include all fittings supplied and follow the instructions provided. Any faults that arise with Thomas Dudley products can be dealt with directly by the manufacturer. Please contact 0121 557 5411.

Due to the photographic and printing process required some images shown within this brochure may not be an exact representation of the finished product. Any products will only match a finished sample provided.

Our policy is one of continuous improvement and we reserve the right to change the specification and design of any Vanity Hall product without prior notice.

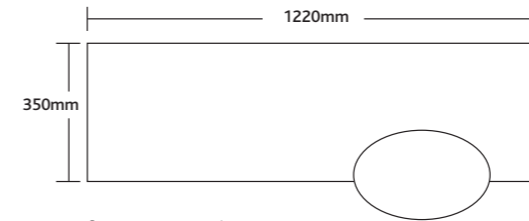

Top [based on 535mm] - £447.00
Semi Counter top bowl (White) - £898.00
TOTAL - £1345.00
Please note: Priced up in CLASSIC Solid Surface section

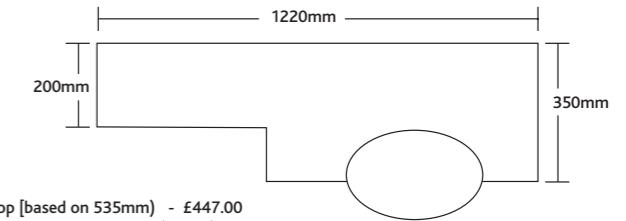

Top [based on 535mm] - £447.00
Semi Counter top bowl (White) - £898.00
Cut back - £184.00
TOTAL - £1529.00
Please note: Priced up in CLASSIC Solid Surface section

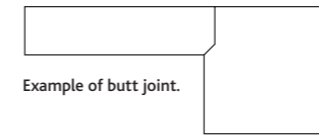

Example of butt joint.

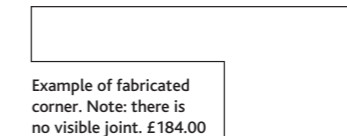

Example of fabricated corner. Note: there is no visible joint. £184.00

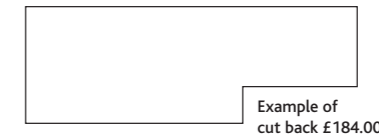

Example of cut back £184.00

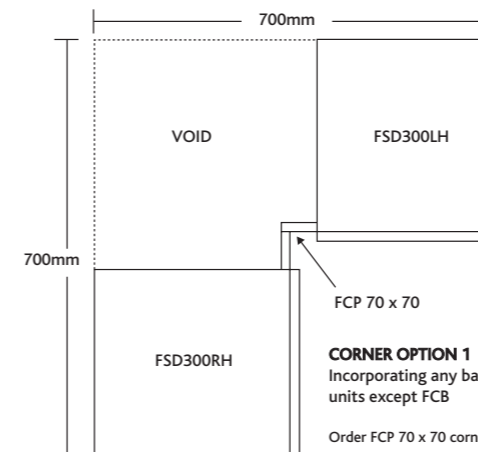

CORNER OPTION 1
Incorporating any base units except FCB
Order FCP 70 x 70 corner post

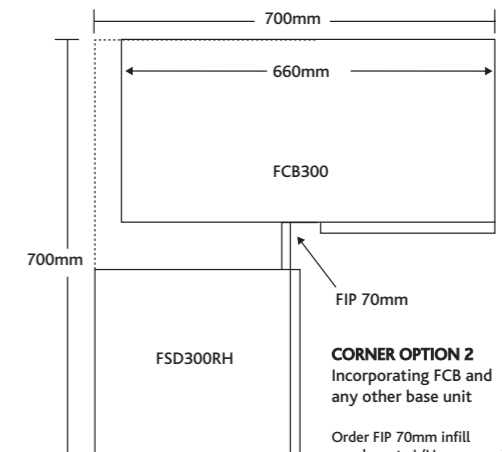

CORNER OPTION 2
Incorporating FCB and any other base unit
Order FIP 70mm infill panel - note L/H corner unit shown

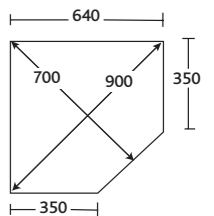

CORNER OPTION 3
FC900

OTHER INFORMATION

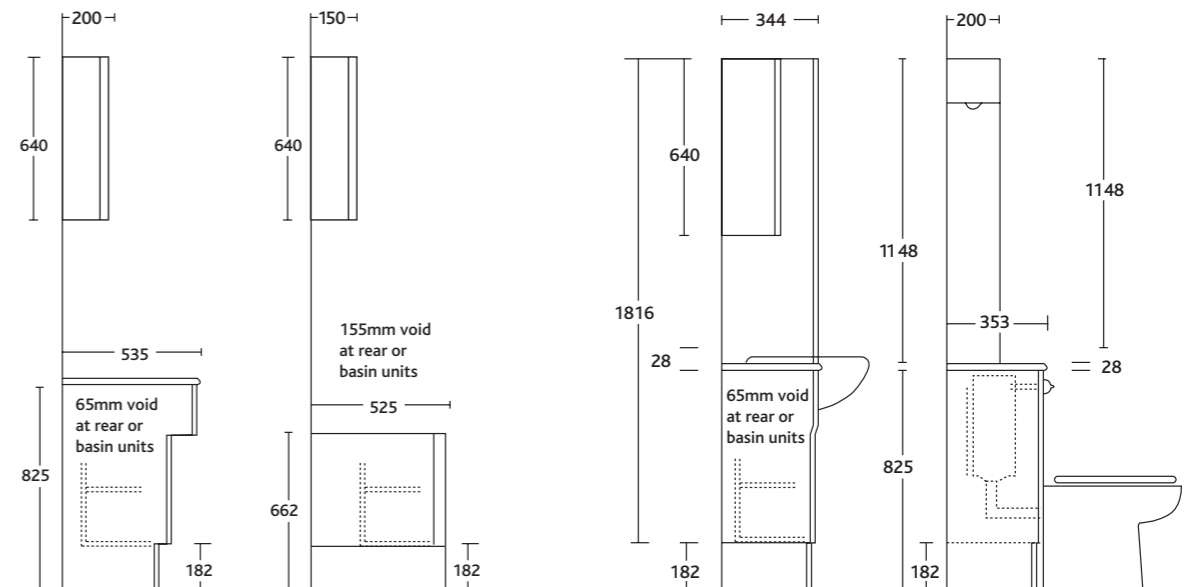

Measurements are in mm. The collection offers a range of Vanity Units and Fitted Furniture which at plinth and carcass height are compatible, designed to give a variety of options in planning your home.

Due to the limitations of the printing process an exact match cannot be guaranteed although every effort is made to ensure the finishes are as close as possible to the finished items. Vanity Hall Furniture would like to thank Duravit, Vado, Matki, Bisque Radiators, Hansgrohe and Crown Tiles. (www.crowntiles.co.uk)



VANITY HALL
COLLECTION

VANITY HALL FURNITURE

Unit 6, Powke Lane Industrial Estate

Powke Lane, Rowley Regis,

West Midlands B65 0AH

Telephone: 0121 561 4555

Facsimile: 0121 559 9610

Email: sales@vanity-hall.com

FIND US ON FACEBOOK & TWITTER

WWW.VANITY-HALL.COM