

Showroom Guide



www.roman-showers.com

**SELECT YOUR
SANCTUARY**



At the heart of Roman is the desire to be the best. It is Roman's vision to lead and innovate in the Showering industry. To design and manufacture top quality inspirational showering solutions, which offers choice for all markets. To expertly manufacture our products in Britain, so they are designed and built to last and offer a lifetime of effortless showering for all. It is our aim to give all our customers exceptional value and service; this ethos runs throughout the culture of the business and cannot be imitated.

Contents

	Pages
Introduction	1 - 5
10 mm Decem^x including Expressions Panels	6 - 38
8 mm Liber8 Frameless Hinged	39 - 48
8 mm Innov8 Frameless Pivoting	49 - 54
8 mm Lumin8 Semi-Frameless	55 - 80
6 mm Embrace Semi-Frameless	81 - 93
4 mm Collage Framed	94 - 100

N.B. Glass thickness for guidance only - please see individual product specification

	Pages
Wetrooms including Select 10mm and 8mm range of panels	101 - 116
Shower Trays	117 - 126
Bath Screens	127 - 142
Accessories	143 - 144
Bespoke Service	145 - 146
Cleaning	147 - 148
Guarantee	149



Who we are

Roman has been designing and manufacturing showering solutions for over 31 years, and is home to the UK's largest shower manufacturing plant. All Roman products are designed and created in Britain, offering the ultimate in quality, precision and craftsmanship. Roman's diverse and versatile collection of products encompasses something for every style and shape bathroom - no matter what the budget.



Products Designed for All

Innovation and exceptional product design differentiates Roman from the competition. Our products are carefully designed for all. We consider different users' needs to give totally effortless entry to the entire family. Whether you would like door-less entry, level access, handles that can be used with a flat hand, or a wider aperture, we have something that will work with your space all finished with a stylish designer look.

Glass

All our enclosures feature toughened safety glass. This is a heat treatment to increase the glass strength to make it around 5 times stronger than normal glass. If the glass were to break due to impact, it would shatter into lots of small pieces which are much less dangerous and will help you avoid any cuts or injury. All glass is strictly tested in accordance with EN14428.

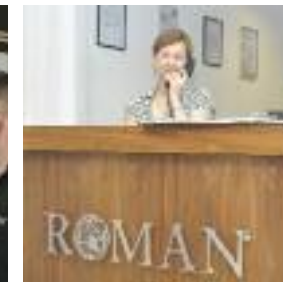

Highest Quality Materials

Roman only use the finest quality of materials to guarantee unsurpassed quality and certainty in our manufacturing process, ensuring all of our products reach exceptional levels of style and performance. We carefully fabricate and anodise all our aluminium profiles. We use aluminium because it is; light, strong and requires minimal maintenance. The anodising process increases corrosion resistance, product durability and further enhances the material properties. Our specialist anodising offers a bright chrome like finish which is significantly in excess of standard aluminium finishing.

Branding

Roman is a reputable and well established UK Brand, now supplying showering products all over the World. Our foundations are strongly rooted in; innovative design, manufacture, quality and customer service. Roman has achieved the leading position in the Market place by consistent and creative product innovation and has produced growth across all UK Market sectors and strong growth in International Markets. Our products are used in some of the finest hotels Worldwide.

Customer Service

Roman has an in-house customer support network, who are there to offer advice and support for each purchase at every stage; from initial enquiry through to after sales care advice. Roman employs over 20 full time members of staff in our Customer Support Centre and over 40 Technical Service Representatives nationwide who all receive comprehensive training on the manufacture and installation of Roman's collection of products.

Award Winning Product Design & Innovation



Innovation and exceptional product design differentiates Roman from the competition. Our products and ranges have won multiple awards. We have been identified as one of London Stock Exchange's 1000 Companies to Inspire Britain. We are extremely proud to be recognised as one of the UK's fastest growing and most dynamic small and medium sized businesses.



Buy with confidence



All Roman products are designed and created specifically for the UK showering market, offering the ultimate in quality, precision and craftsmanship. All Roman's manufacturing processes are carried out at our UK Manufacturing Plant and Headquarters and meet and exceed approved UK and European testing standards.



For complete peace of mind, all Roman Shower Enclosures and Bath Screens are accompanied by a fully service backed Truelife Lifetime Guarantee.



For project applications Roman products are available as a BIM file download from:
www.roman-showers/available-downloads.com



We work with a wide range of Pod manufacturers on four continents.

Glass Protection



All Roman's enclosures and bath screens are pre-coated with Roman Ultra Care, our own unique glass protection system. (For full details see page 147)

Helping you to design your bathroom



Roman products are available on the Virtual Worlds design service. For more information contact Roman Customer Relations 01325 328033



Roman products are available on the Fusion design service. For more information contact Roman Customer Relations 01325 328033



Making your product selection easier. Roman products are available on EQ software. For more information contact Customer Relations on 01325 328033.

Pricing - VAT is calculated at 20% rate.

Roman have an ongoing policy of design, development and improvement and thus reserve the right to modify specification, ranges and prices without prior notice. Images are for illustration purposes only - please refer to your retailer as site conditions will vary or contact Roman Customer Relations on 01325 328033 for installation specifications.



Introduction to door styles

Quadrant

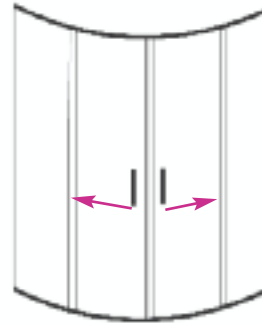

The Quadrant shaped enclosure will sit beautifully in the corner of your bathroom, making it an ideal solution for the smaller bathroom. It incorporates unobtrusive sliding doors.

Sliding Door

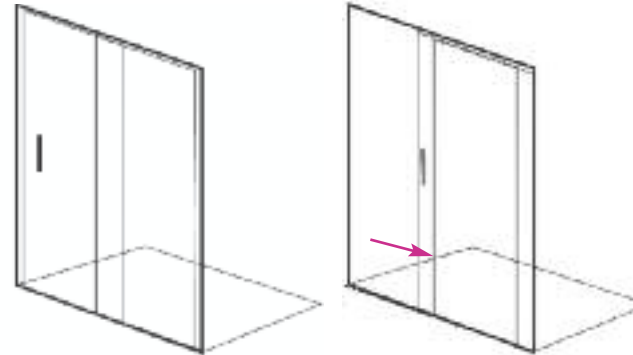

The sliding door action offers wide and easy access, with no protrusion into the bathroom or showering area.

Neo-Angle

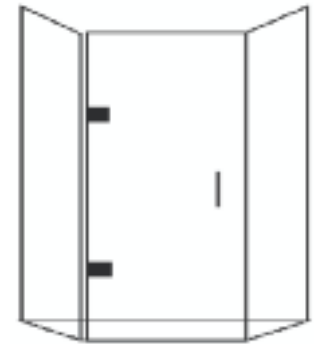

This flexible design allows for inward or outward opening door entry. It presents a unique footprint, to work around existing fixtures and fittings.

Bi-Fold Door

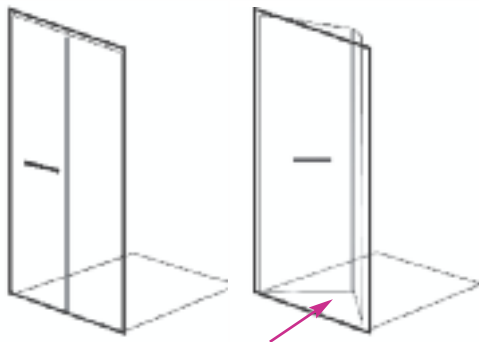

Inward opening door presents a flexible space saving solution. Avoids existing fixtures and fittings in the bathroom area.

Pivot and In-Swing Doors

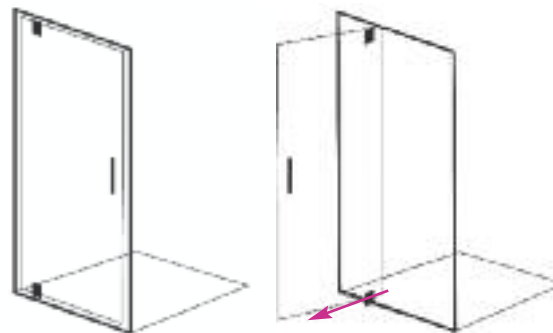

Outward opening door, takes up minimal external space due to the positioning of the hinge point, meaning it protrudes less into the bathroom space.

Hinged Door

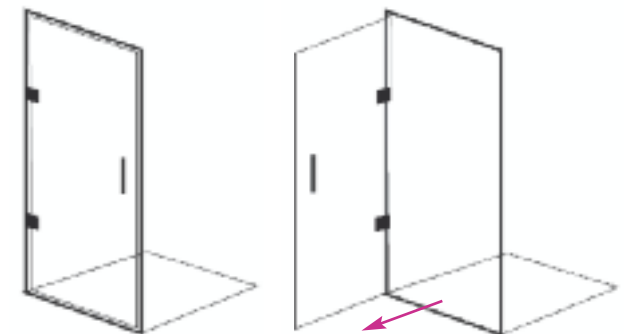

Smooth outward opening door, featuring soft self-close hinges for a superior finish.

For Wetroom Panel styles see pages 30-38 and 102-112

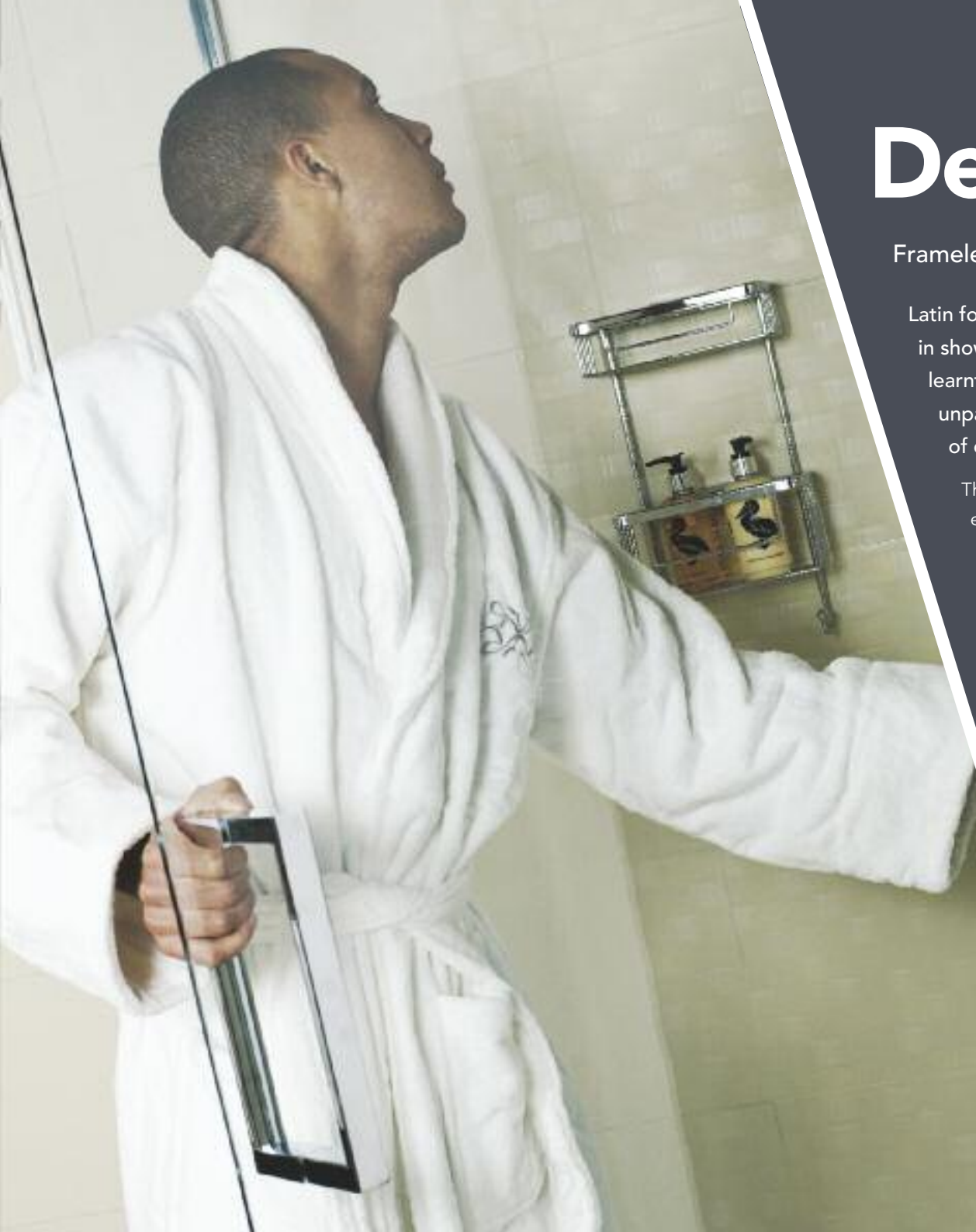

Decem^x

Frameless Collection

Latin for 10, the Decem 10mm thick glass range is the ultimate in showering design. We have combined everything we have learnt about showering over the last 31 years to create this unparalleled range, which for the first time presents a series of design options for selected products.

The Decem range has been meticulously designed and engineered by our Roman Design experts. Components of the highest quality have been brought together. With 10mm thick toughened glass. Chromed Brass Hardware. Minimalist framing for a design perspective. Standing majestically at a height of 2000mm. Hardware and handle options available so you can create your desired effect. Ultra-Care Glass Protection Pre-coating included as standard. All combined to create a stunningly visual range with is guaranteed for life.

- Sliding Door Enclosures
- Hinged Door Enclosures
- Neo-Angle Enclosures
- Walk-ins
 - Expressions – Open Plan Showering
 - Hinged Bath Screen

10mm Decem^x

Decem^x



Bracing

An optional chromed brass bracing arm is supplied as standard with many of our products, to give additional support if required. The bracing arm has been intricately designed to sit discreetly on the product, offering a minimalist finish, whilst providing maximum support. Total height including bracing is 2030mm.



Water Safe System

Our unique Water Safe System has been engineered to offer the maximum water integrity available for a minimalist designed enclosure. The system will guide the water back into your showering area, to enhance performance. It creates a water barrier to eliminate this as a traditional weak spot.



Hinges and Handle

Self-closing hinges offer a superior action and create a positive seal for the door. Made from chromed brass components to give a quality finish and long lasting performance. Choose between curved or square hardware to suit your taste.

Our chromed brass handle is available in a curved or square finish to suit your taste. The feature handle looks stylish, whilst being suitable for all users. It can be operated with a flat hand for easy opening.



Printed Glass Technology

Introducing our digitally printed glass wetroom panels, featuring three design options: Distressed Brick; Glass Block; and a Rainforest image. This is a technology breakthrough, which has been achieved by collaboration of technologies with digital print specialists Dimax.



Detailing

To ensure the Decem^x range is sublime, our Design team focussed in on the detail. From the enhanced product adjustment, to our Water Safe System. From the chromed brass branding badge, to the 10mm thick toughened glass. From the pre-coated glass protection, to the increased glass height of 2000mm. We have selected the best materials to craft exceptional components, to offer a superior showering experience.

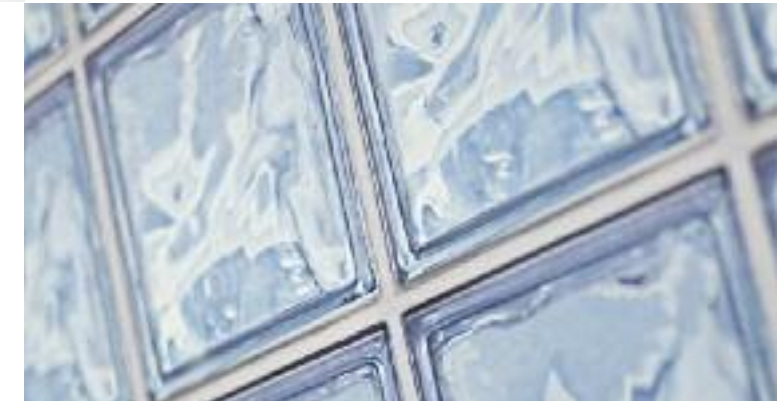





1200 Alcove Fitting

- Door DXT12AL (left hand)
- Grey Shimmer Infinity Shower Tray IAG129G

Features and Benefits:

- 10mm glass
- 2000mm high (wall profile height)
2020mm high (to top of door glass)
- Silent and ultra-smooth running roller bearing system
- Luxury 'soft close' door system
- Chromed brass machined components
- Chromed brass feature handle
- Low profile PVC seals
- Bright silver frame
- 15mm of adjustment in each profile
- Roman Water Safe System to tray or floor
- Alcove and corner options
- Please indicate handing (RH or LH) when ordering
- Available with square hardware.

Square Hardware



Corner fitting

Enclosure Size (mm)	Handing Style	Adjustment (mm)	Door Aperture (mm)	Order Codes Required: Door	Side Panel	Total Cost ex VAT	Total Cost inc VAT
1200 x 800	Left Hand	1165 - 1180 & 765 - 780	418	DXT12L	DX2R8	£1458.34	£1750.00
1200 x 800	Right Hand	1165 - 1180 & 765 - 780	418	DXT12R	DX2R8	£1458.34	£1750.00
1200 x 900	Left Hand	1165 - 1180 & 865 - 880	418	DXT12L	DX2R9	£1500.00	£1800.00
1200 x 900	Right Hand	1165 - 1180 & 865 - 880	418	DXT12R	DX2R9	£1500.00	£1800.00
1400 x 800	Left Hand	1365 - 1380 & 765 - 780	518	DXT14L	DX2R8	£1541.67	£1850.00
1400 x 800	Right Hand	1365 - 1380 & 765 - 780	518	DXT14R	DX2R8	£1541.67	£1850.00
1400 x 900	Left Hand	1365 - 1380 & 865 - 880	518	DXT14L	DX2R9	£1583.33	£1900.00
1400 x 900	Right Hand	1365 - 1380 & 865 - 880	518	DXT14R	DX2R9	£1583.33	£1900.00
1700 x 800	Left Hand	1665 - 1680 & 765 - 780	668	DXT17L	DX2R8	£1666.67	£2000.00
1700 x 800	Right Hand	1665 - 1680 & 765 - 780	668	DXT17R	DX2R8	£1666.67	£2000.00

Alcove fitting

Door Size (mm)	Handing Style	Adjustment (mm)	Door Aperture (mm)	Order Code Required: Door	Total Cost ex VAT	Total Cost inc VAT
1200	Left Hand	1165 - 1190	430	DXT12AL	£1041.67	£1250.00
1200	Right Hand	1165 - 1190	430	DXT12AR	£1041.67	£1250.00
1400	Left Hand	1365 - 1390	530	DXT14AL	£1125.00	£1350.00
1400	Right Hand	1365 - 1390	530	DXT14AR	£1125.00	£1350.00
1700	Left Hand	1665 - 1690	680	DXT17AL	£1250.00	£1500.00
1700	Right Hand	1665 - 1690	680	DXT17AR	£1250.00	£1500.00

Compatible Trays:	Page
Infinity Trays	119 - 120
Anti-Slip Trays	121
Roman Low Level Trays	125 - 126
Roman Shield System	114 - 116

Sliding Door with square hardware

The sublime Sliding Door Enclosure stands at an impressive height of 2000mm with luxury 10mm thick toughened glass. The Sliding Door features a soft close door system, to present a silent and ultra-smooth running door action. The minimalistic enclosure incorporates Roman's Water Safe System to direct the water back into the showering area.

10mm



1700 x 800 Corner Fitting

- Door DXT17L (left hand) and Side Panel DX2R8
- Roman Low Level Tray RLT178
- Shower Basket RSB01



1700 x 800 Corner Fitting

- Door DX117FL (left hand) and Side Panel DX2R8
- Roman Low Level Tray RLT178
- Shower Basket RSB01

Features and Benefits:

- 10mm glass
- 2000mm high (wall profile height)
2020mm high (to top of door glass)
- Silent and ultra-smooth running roller bearing system
- Luxury 'soft close' door system
- Chromed brass machined components
- Chromed brass finger pull handle
- Low profile PVC seals
- Bright silver frame
- 15mm of adjustment in each profile
- Roman Water Safe System to tray or floor
- Alcove and corner options
- Please indicate handing (RH or LH) when ordering

Finger pull handle



Corner fitting

Enclosure Size (mm)	Handing Style	Adjustment (mm)	Door Aperture (mm)	Order Codes Required: Door	Side Panel	Total Cost ex VAT	Total Cost inc VAT
1200 x 800	Left Hand	1165 - 1180 & 765 - 780	418	DXT12FL	DX2R8	£1458.34	£1750.00
1200 x 800	Right Hand	1165 - 1180 & 765 - 780	418	DXT12FR	DX2R8	£1458.34	£1750.00
1200 x 900	Left Hand	1165 - 1180 & 865 - 880	418	DXT12FL	DX2R9	£1500.00	£1800.00
1200 x 900	Right Hand	1165 - 1180 & 865 - 880	418	DXT12FR	DX2R9	£1500.00	£1800.00
1400 x 800	Left Hand	1365 - 1380 & 765 - 780	518	DXT14FL	DX2R8	£1541.67	£1850.00
1400 x 800	Right Hand	1365 - 1380 & 765 - 780	518	DXT14FR	DX2R8	£1541.67	£1850.00
1400 x 900	Left Hand	1365 - 1380 & 865 - 880	518	DXT14FL	DX2R9	£1583.33	£1900.00
1400 x 900	Right Hand	1365 - 1380 & 865 - 880	518	DXT14FR	DX2R9	£1583.33	£1900.00
1700 x 800	Left Hand	1665 - 1680 & 765 - 780	668	DXT17FL	DX2R8	£1666.67	£2000.00
1700 x 800	Right Hand	1665 - 1680 & 765 - 780	668	DXT17FR	DX2R8	£1666.67	£2000.00

Alcove fitting

Door Size (mm)	Handing Style	Adjustment (mm)	Door Aperture (mm)	Order Code Required: Door	Total Cost ex VAT	Total Cost inc VAT
1200	Left Hand	1165 - 1190	430	DXT12AFL	£1041.67	£1250.00
1200	Right Hand	1165 - 1190	430	DXT12AFR	£1041.67	£1250.00
1400	Left Hand	1365 - 1390	530	DXT14AFL	£1125.00	£1350.00
1400	Right Hand	1365 - 1390	530	DXT14AFR	£1125.00	£1350.00
1700	Left Hand	1665 - 1690	680	DXT17AFL	£1250.00	£1500.00
1700	Right Hand	1665 - 1690	680	DXT17AFR	£1250.00	£1500.00

Compatible Trays:	Page
Infinity Trays	119 - 120
Anti-Slip Trays	121
Roman Low Level Trays	125 - 126
Roman Shield System	114 - 116

Sliding Door with finger pull handle

The stand out feature of this enclosure is its luxury cushioned close door operation. This superior enclosure is perfectly completed with chromed brass machined components and a bright silver frame with the option of either a chromed brass designer handle or a finger pull framed with chromed brass, creating a truly opulent design.

10mm



1700 Alcove Fitting

- Door DXT17AFL (left hand)
- Roman Low Level Tray RLT178
- Shower Basket RSB05



- 1600 x 800 Configuration 1**
- Sliding Door with One Side Panel ST116C1
 - Infinity Tray IA168
 - Shower Basket RSB02

Features and Benefits:

- 10mm glass
- 1950mm high (wall profile height)
2022 including bearings
- Silent and ultra-smooth running roller bearing system
- Luxury 'soft close' door system
- Chromed brass machined components
- Chromed brass curved handle
- Low profile PVC seals
- Bright silver frame
- 10mm of adjustment in each profile
- Reversible for left or right hand fitting

Sliding Door with Curved Hardware

Install with a side panel for corner configuration. Available with two left or right hand configurations to give access where required. Enhanced bracing system with compression fast fix system for easy assembly. This enclosure is completed with bright silver chromed brass components, including the contemporary curved handle and cruded brackets.

10mm

Code	Size (mm)	Aperture (mm)	Door Adjustment (mm)	Panel Adjustment (mm)	£ ex vat	£ inc vat
Configuration 1 - door closing onto glass panel.						
ST1128C1	1200 x 800	480	1180 - 1190	770 - 780	£1321.04	£1585.25
ST1129C1	1200 x 900	480	1180 - 1190	870 - 880	£1362.33	£1634.80
ST114C1	1400 x 900	580	1380 - 1390	870 - 880	£1444.89	£1733.87
ST116C1	1600 x 800	580	1580 - 1590	770 - 780	£1527.46	£1832.95
Configuration 2 - door closing onto wall.						
ST1128C2	1200 x 800	480	1180 - 1190	770 - 780	£1321.04	£1585.25
ST1129C2	1200 x 900	480	1180 - 1190	870 - 880	£1362.33	£1634.80
ST114C2	1400 x 900	580	1380 - 1390	870 - 880	£1444.89	£1733.87
ST116C2	1600 x 800	680	1580 - 1590	770 - 780	£1527.46	£1832.95

Compatible Trays:	Page
Infinity Trays	119 - 120
Anti-Slip Trays	121
Roman Low Level Trays	125 - 126
Roman Shield System	114 - 116



1200 x 800 Configuration 2

- Door with One Side Panel ST1128C2
- Infinity Tray IA128
- Shower Basket RSB03

Soft-close system

1200 Alcove Fitting

- Door ST12A
- Anti-Slip Tray RST128
- Shower Basket RSB04

Features and Benefits:

- 10mm glass
- 1950mm high (wall profile height)
2022 including bearings
- Silent and ultra-smooth running roller bearing system
- Luxury 'soft close' door system
- Chromed brass machined components
- Chromed brass curved handle
- Low profile PVC seals
- Bright silver frame
- 10mm of adjustment in each profile



Soft Close System

Code	Size (mm)	Aperture (mm)	Door Adjustment (mm)	Panel Adjustment (mm)	£ ex vat	£ inc vat
Alcove Fitting						
ST12A	1200	480	1180 - 1200	-	£949.50	£1139.40
ST14A	1400	580	1380 - 1400	-	£1032.07	£1238.48
ST16A	1600	680	1580 - 1600	-	£1114.63	£1337.56
Straight Wall fitting (Door with Two Side Panels)						
ST2128	1200 x 800	480	10 each profile	770 - 780	£1527.46	£1832.95
ST2129	1200 x 900	480	10 each profile	870 - 880	£1568.74	£1882.49
ST214	1400 x 900	580	10 each profile	870 - 880	£1651.30	£1981.56
ST216	1600 x 800	680	10 each profile	770 - 780	£1733.87	£2080.64

Compatible Trays:	Page
Infinity Trays	119 - 120
Anti-Slip Trays	121
Roman Low Level Trays	125 - 126
Roman Shield System	114 - 116

Sliding Door with Curved Hardware

Soft close pistons and super smooth action for an effortless slide. Install straight to floor, or to low level tray. The Sliding Door offers wide and easy access and there is no protrusion into the showering or bathroom space, which presents flexibility for bathroom fixtures and fittings. The finishing touch to this stylish design is the beautifully curved chromed brass handle.

10mm



1200 x 800 Straight Wall Fitting

- Door ST2128
- Roman Shield Wetroom System
- Shower Basket RSB06



900 x 900 Corner Fitting

- Door DXL9CA
- Side Panel DXR9
- Roman Low Level Tray RLT9
- Shower Basket RSB07

Features and Benefits:

- 10mm glass
- Glass height - 2000mm
- Self-closing hinges
- Choice of curved or square chromed brass handle and hinges
- Bracing bar for optional usage supplied as standard with corner option
- Integrated 'tray or floor' Water Safe System
- Suitable for installation onto tray or wetroom floor
- Roman Ultra Care glass protection included
- 15mm of adjustment in each minimal wall profile for easy installation
- All door and panel sizes are interchangeable to create the enclosure size of your choice

Please note: Product codes and prices have been split to enable easy selection of your chosen door and panel sizes.

N.B.: Alcove Door prices/codes differ from Corner Fitting Door prices/codes as different components are included for Alcove Fitting.

Corner fitting

Door Size (mm)	Hardware Style	Adjustment (mm)	Door Aperture/ Projection (mm)	Order Code Required: Door	Cost ex VAT	Cost inc VAT
760	Curved	725 - 740	630	DXL76CA	£538.13	£645.76
800	Curved	765 - 780	670	DXL8CA	£546.87	£656.24
900	Curved	865 - 880	770	DXL9CA	£555.62	£666.74
1000	Curved	965 - 980	870	DXL10CA	£564.38	£677.26
760	Square	725 - 740	630	DXL76CB	£538.13	£645.76
800	Square	765 - 780	670	DXL8CB	£546.87	£656.24
900	Square	865 - 880	770	DXL9CB	£555.62	£666.74
1000	Square	965 - 980	870	DXL10CB	£564.38	£677.26

Side Panel Size (mm)	Hardware Style	Adjustment (mm)	Order Code Required: Side Panel	Cost ex VAT	Cost inc VAT
760	-	725 - 740	DXR76	£538.13	£645.76
800	-	765 - 780	DXR8	£546.87	£656.24
900	-	865 - 880	DXR9	£555.62	£666.74
1000	-	965 - 980	DXR10	£564.38	£677.26

Alcove fitting

Door Size (mm)	Hardware Style	Adjustment (mm)	Door Aperture/ Projection (mm)	Order Code Required: Door	Cost ex VAT	Cost inc VAT
760	Curved	720 - 750	710	DXL76A	£857.50	£1029.00
800	Curved	760 - 790	750	DXL8A	£866.25	£1039.50
900	Curved	860 - 890	850	DXL9A	£875.00	£1050.00
1000	Curved	960 - 990	950	DXL10A	£883.75	£1060.50
760	Square	720 - 750	710	DXL76B	£857.50	£1029.00
800	Square	760 - 790	750	DXL8B	£866.25	£1039.50
900	Square	860 - 890	850	DXL9B	£875.00	£1050.00
1000	Square	960 - 990	950	DXL10B	£883.75	£1060.50

Compatible Trays:
 Infinity Trays
 Anti-Slip Trays
 Roman Low Level Trays
 Roman Shield System

Page
 119 - 120
 121
 125 - 126
 114 - 116

Curved Hardware



Square Hardware



900 Alcove Fitting

- Door DXL9B
- Roman Low Level Tray RLT79
- Shower Basket RSB07

Hinged Door

Install alone or combine with Side Panels, or In-Line Panels. Choose from a variety of size options and configurations. Self-closing hinges for an effortless action. Install to tray or wetroom floor. Choose from curved or square hardware and feature handle. Integrated Water Safe System for unparalleled water integrity.

10mm





1200 Alcove Fitting

- Door DXL1HDB
- In-Line Panel DXL1H12
- Roman Low Level Tray RLT129
- Shower Basket RSB07

Features and Benefits:

- Glass height - 2000mm (2030mm with brace bar)
- Self-closing hinges
- Choice of curved or square chromed brass handle and hinges
- Decem^x bracing bar for optional usage supplied as standard
- Integrated 'tray or floor' Water Safe System
- Suitable for installation onto tray or wetroom floor
- Roman Ultra Care glass protection included
- 15mm of adjustment in each minimal wall profile for easy installation
- Reversible for left or right hand fitting
- Door aperture 630mm

Please note:

Door aperture/projection is 630mm approx. - enclosure size required is achieved by size of In-Line and Side Panels (this is reflected in Order Codes).

Corner fitting

Enclosure Size (mm)	Hardware Style	Adjustment (mm)	Order Codes required:			Total Cost ex VAT	Total Cost inc VAT
			Door	In-Line Panel	Side Panel		
1000 x 800	Curved	965 - 980 & 765 - 780	DXL1HDRA	DXL1HR10	DXHR8	£1268.74	£1522.48
1000 x 800	Square	965 - 980 & 765 - 780	DXL1HDRB	DXL1HR10	DXHR8	£1268.74	£1522.48
1000 x 900	Curved	965 - 980 & 865 - 880	DXL1HDRA	DXL1HR10	DXHR9	£1312.50	£1574.99
1000 x 900	Square	965 - 980 & 865 - 880	DXL1HDRB	DXL1HR10	DXHR9	£1312.50	£1574.99
1200 x 800	Curved	1165 - 1180 & 765 - 780	DXL1HDRA	DXL1HR12	DXHR8	£1399.99	£1679.98
1200 x 800	Square	1165 - 1180 & 765 - 780	DXL1HDRB	DXL1HR12	DXHR8	£1399.99	£1679.98
1200 x 900	Curved	1165 - 1180 & 865 - 880	DXL1HDRA	DXL1HR12	DXHR9	£1443.75	£1732.49
1200 x 900	Square	1165 - 1180 & 865 - 880	DXL1HDRB	DXL1HR12	DXHR9	£1443.75	£1732.49
1400 x 800	Curved	1365 - 1380 & 765 - 780	DXL1HDRA	DXL1HR14	DXHR8	£1443.75	£1732.50
1400 x 800	Square	1365 - 1380 & 765 - 780	DXL1HDRB	DXL1HR14	DXHR8	£1443.75	£1732.50
1400 x 900	Curved	1365 - 1380 & 865 - 880	DXL1HDRA	DXL1HR14	DXHR9	£1487.51	£1785.01
1400 x 900	Square	1365 - 1380 & 865 - 880	DXL1HDRB	DXL1HR14	DXHR9	£1487.51	£1785.01
1600 x 800	Curved	1565 - 1580 & 765 - 780	DXL1HDRA	DXL1HR16	DXHR8	£1575.00	£1890.00
1600 x 800	Square	1565 - 1580 & 765 - 780	DXL1HDRB	DXL1HR16	DXHR8	£1575.00	£1890.00
1600 x 900	Curved	1565 - 1580 & 865 - 880	DXL1HDRA	DXL1HR16	DXHR9	£1618.76	£1942.51
1600 x 900	Square	1565 - 1580 & 865 - 880	DXL1HDRB	DXL1HR16	DXHR9	£1618.76	£1942.51

Alcove fitting

Enclosure Size (mm)	Hardware Style	Adjustment (mm)	Order Codes required:		Total Cost ex VAT	Total Cost inc VAT
			Door	In-Line Panel		
1000	Curved	960 - 990	DXL1HDA	DXL1H10	£962.50	£1155.00
1000	Square	960 - 990	DXL1HDB	DXL1H10	£962.50	£1155.00
1200	Curved	1160 - 1190	DXL1HDA	DXL1H12	£1050.00	£1260.00
1200	Square	1160 - 1190	DXL1HDB	DXL1H12	£1050.00	£1260.00
1400	Curved	1360 - 1390	DXL1HDA	DXL1H14	£1137.50	£1365.00
1400	Square	1360 - 1390	DXL1HDB	DXL1H14	£1137.50	£1365.00
1600	Curved	1560 - 1590	DXL1HDA	DXL1H16	£1225.00	£1470.00
1600	Square	1560 - 1590	DXL1HDB	DXL1H16	£1225.00	£1470.00

Compatible Trays:

Infinity Trays
Anti-Slip Trays
Roman Low Level Trays
Roman Shield System

Page

119 - 120
121
125 - 126
114 - 116

Hinged Door with One In-Line Panel for Corner or Alcove fitting

10mm



Curved Hardware



Square Hardware



1200 x 900 Corner Fitting

- Door DXL1HDRA
- Side Panel DXHR9
- In-Line Panel DXL1HR12
- Roman Low Level Tray RLT129
- Shower Basket RSB07



1200 x 800 Corner Fitting

- Hinged Door DXLHDRA
- In-Line Panel DXLHR12
- Side Panel DXHR8
- Roman Low Level Tray RLT128
- Shower Basket RSB01

Features and Benefits:

- 10mm glass
- Glass height - 2000mm (2030mm with brace bar)
- Self-closing hinges
- Choice of curved or square chromed brass handle and hinges
- Decem^x bracing bar for optional usage supplied as standard
- Integrated 'tray or floor' Water Safe System
- Suitable for installation onto tray or wetroom floor
- Roman Ultra Care glass protection included
- 15mm of adjustment in each minimal wall profile for easy installation
- Reversible for left or right hand fitting
- Door aperture 650mm

Corner fitting

Please note: Door aperture/projection is 650mm approx - enclosure size required is achieved by size of In-Line and Side Panels (this is reflected in Order Codes). In-Line Panels are in packs of two so one order code required only.

Enclosure Size (mm)	Hardware Style	Adjustment (mm)	Order Codes required:			Total Cost ex VAT	Total Cost inc VAT
			Door	In-Line Panels	Side Panel		
1200 x 800	Curved	1165 - 1180 & 765 - 780	DXLHDB	DXLHR12	DXHR8	£1399.99	£1679.98
1200 x 800	Square	1165 - 1180 & 765 - 780	DXLHDB	DXLHR12	DXHR8	£1399.99	£1679.98
1200 x 900	Curved	1165 - 1180 & 865 - 880	DXLHDB	DXLHR12	DXHR9	£1443.75	£1732.49
1200 x 900	Square	1165 - 1180 & 865 - 880	DXLHDB	DXLHR12	DXHR9	£1443.75	£1732.49
1400 x 800	Curved	1365 - 1380 & 765 - 780	DXLHDB	DXLHR14	DXHR8	£1443.75	£1732.50
1400 x 800	Square	1365 - 1380 & 765 - 780	DXLHDB	DXLHR14	DXHR8	£1443.75	£1732.50
1400 x 900	Curved	1365 - 1380 & 865 - 880	DXLHDB	DXLHR14	DXHR9	£1487.51	£1785.01
1400 x 900	Square	1365 - 1380 & 865 - 880	DXLHDB	DXLHR14	DXHR9	£1487.51	£1785.01
1500 x 800	Curved	1465 - 1480 & 765 - 780	DXLHDB	DXLHR15	DXHR8	£1545.50	£1815.00
1500 x 800	Square	1465 - 1480 & 765 - 780	DXLHDB	DXLHR15	DXHR8	£1545.50	£1815.00
1500 x 900	Curved	1465 - 1480 & 865 - 880	DXLHDB	DXLHR15	DXHR9	£1556.26	£1867.51
1500 x 900	Square	1465 - 1480 & 865 - 880	DXLHDB	DXLHR15	DXHR9	£1556.26	£1867.51
1600 x 800	Curved	1565 - 1580 & 765 - 780	DXLHDB	DXLHR16	DXHR8	£1575.00	£1890.00
1600 x 800	Square	1565 - 1580 & 765 - 780	DXLHDB	DXLHR16	DXHR8	£1575.00	£1890.00
1600 x 900	Curved	1565 - 1580 & 865 - 880	DXLHDB	DXLHR16	DXHR9	£1618.76	£1942.51
1600 x 900	Square	1565 - 1580 & 865 - 880	DXLHDB	DXLHR16	DXHR9	£1618.76	£1942.51

Alcove fitting

Please note: In-Line Panels are in packs of two so one order code required only.

Enclosure Size (mm)	Hardware Style	Adjustment (mm)	Order Codes required:		Total Cost ex VAT	Total Cost inc VAT
			Door	In-Line Panels		
1200	Curved	1160 - 1190	DXLHDA	DXLH12	£1050.00	£1260.00
1200	Square	1160 - 1190	DXLHDB	DXLH12	£1050.00	£1260.00
1400	Curved	1360 - 1390	DXLHDA	DXLH14	£1137.50	£1365.00
1400	Square	1360 - 1390	DXLHDB	DXLH14	£1137.50	£1365.00
1500	Curved	1460 - 1490	DXLHDA	DXLH15	£1183.33	£1420.00
1500	Square	1460 - 1490	DXLHDB	DXLH15	£1183.33	£1420.00
1600	Curved	1560 - 1590	DXLHDA	DXLH16	£1225.00	£1470.00
1600	Square	1560 - 1590	DXLHDB	DXLH16	£1225.00	£1470.00

Compatible Trays:
 Infinity Trays
 Anti-Slip Trays
 Roman Low Level Trays
 Roman Shield System

Page
 119 - 120
 121
 125 - 126
 114 - 116



Curved Hardware



Square Hardware



1200 Alcove Fitting

- Door DXLHDB
- In-Line Panel DXLH12
- Roman Low Level RLT129
- Shower Basket RSB02

Hinged Door with Two In-Line Panels

Make a style statement with the Hinged Door and In-Line Panel for corner or alcove fitting. Create your individual bathroom space with a choice of hardware available. The self-closing hinges ensure a luxury opening and closing door operation.

10mm



1200 x 900 Corner Fitting

- Hinged Door DXL2HDA
- In-Line Panel DXL2HR12
- Side Panel DX1R9
- Roman Shield Wetroom System
- Shower Basket RSB01

Features and Benefits:

- 10mm glass
- Glass height - 2000mm (2030mm with brace bar)
- Self-closing hinges
- Choice of curved or square chromed brass handle and hinges
- Decem^x bracing bar for optional usage supplied as standard
- Integrated 'tray or floor' Water Safe System
- Suitable for installation onto tray or wetroom floor
- Roman Ultra Care glass protection included
- 15mm of adjustment in each minimal wall profile for easy installation
- Reversible for left or right hand fitting
- Door aperture:
670mm corner fitting, 650mm alcove fitting

Please note:

Door aperture/projection is 670mm - enclosure size required is achieved by size of In-Line and Side Panels (this is reflected in Order Codes).

Corner fitting

Enclosure Size (mm)	Hardware Style	Adjustment (mm)	Order Codes required:			Total Cost ex VAT	Total Cost inc VAT
			Door	In-Line Panel	Side Panel		
1000 x 760	Curved	965 - 980 & 725 - 740	DXL2HDRA	DXL2HR10	DX1R76	£1225.00	£1470.00
1000 x 760	Square	965 - 980 & 725 - 740	DXL2HDRB	DXL2HR10	DX1R76	£1225.00	£1470.00
1000 x 800	Curved	965 - 980 & 765 - 780	DXL2HDRA	DXL2HR10	DX1R8	£1268.76	£1522.52
1000 x 800	Square	965 - 980 & 765 - 780	DXL2HDRB	DXL2HR10	DX1R8	£1268.76	£1522.52
1000 x 900	Curved	965 - 980 & 865 - 880	DXL2HDRA	DXL2HR10	DX1R9	£1312.50	£1575.00
1000 x 900	Square	965 - 980 & 865 - 880	DXL2HDRB	DXL2HR10	DX1R9	£1312.50	£1575.00
1000 x 1000	Curved	965 - 980 & 965 - 980	DXL2HDRA	DXL2HR10	DX1R10	£1400.01	£1680.02
1000 x 1000	Square	965 - 980 & 965 - 980	DXL2HDRB	DXL2HR10	DX1R10	£1400.01	£1680.02
1200 x 760	Curved	1165 - 1180 & 725 - 740	DXL2HDRA	DXL2HR12	DX1R76	£1356.25	£1627.50
1200 x 760	Square	1165 - 1180 & 725 - 740	DXL2HDRB	DXL2HR12	DX1R76	£1356.25	£1627.50
1200 x 800	Curved	1165 - 1180 & 765 - 780	DXL2HDRA	DXL2HR12	DX1R8	£1400.01	£1680.02
1200 x 800	Square	1165 - 1180 & 765 - 780	DXL2HDRB	DXL2HR12	DX1R8	£1400.01	£1680.02
1200 x 900	Curved	1165 - 1180 & 865 - 880	DXL2HDRA	DXL2HR12	DX1R9	£1443.75	£1732.50
1200 x 900	Square	1165 - 1180 & 865 - 880	DXL2HDRB	DXL2HR12	DX1R9	£1443.75	£1732.50
1200 x 1000	Curved	1165 - 1180 & 965 - 980	DXL2HDRA	DXL2HR12	DX1R10	£1531.26	£1837.52
1200 x 1000	Square	1165 - 1180 & 965 - 980	DXL2HDRB	DXL2HR12	DX1R10	£1531.26	£1837.52

Please note:

Door aperture/projection is 650mm - enclosure size required is achieved by size of In-Line Panel (this is reflected in Order Codes).

Alcove fitting

Enclosure Size (mm)	Hardware Style	Adjustment (mm)	Order Codes required:		Total Cost ex VAT	Total Cost inc VAT
			Door	In-Line Panel		
1000	Curved	960 - 990	DXL2HDA	DXL2H10	£962.50	£1155.00
1000	Square	960 - 990	DXL2HDB	DXL2H10	£962.50	£1155.00
1200	Curved	1160 - 1190	DXL2HDA	DXL2H12	£1050.00	£1260.00
1200	Square	1160 - 1190	DXL2HDB	DXL2H12	£1050.00	£1260.00

Compatible Trays:
Infinity Trays
Anti-Slip Trays
Roman Low Level Trays
Roman Shield System

Page
119 - 120
121
125 - 126
114 - 116

Hinged Door with Hinged In-Line Panel

With luxury 10mm thick glass and reaching a height of 2000mm this stunning enclosure will create a luxury showering experience. We offer various size and configuration options to provide a size and style to fit any bathroom situation.

10mm



Curved Hardware



Square Hardware



1200 Alcove Fitting

- Hinged Door DXL2HDB
- In-Line Panel DXL2H12
- Roman Low Level Tray RLT128



1200 x 900 Neo Angle

- Neo-Angle Door DXPDB
- Neo-Angle Panels DXP129PAL
- Neo-Angle Shower Tray DNT129L
- Shower Basket RSB01

Features and Benefits:

- 10mm glass
- 2000mm high (wall profile height)
- 2005mm high (to top of bracing)
- Chromed brass machined components
- Chromed brass self-closing hinges
- Chromed brass feature handle
- Low profile PVC seals
- Bright silver frame
- 15mm of adjustment in each profile
- Integrated 'tray or floor' Water Safe System
- Please indicate handing (RH or LH) when ordering
- Available only with square hardware
- Suitable for installation to Neo tray or straight to floor

Please note:

Door aperture/projection is 660mm - enclosure size required is achieved by size of Neo Panels (this is reflected in Order Codes).

Neo-Angle Enclosure

Enclosure Size (mm)	Handing Style	Adjustment (mm)	Order Codes required:		Total Cost ex VAT	Total Cost inc VAT
			Door	Neo Panels		
900 x 900	Left Hand	860 - 875	DXPDB	DXP9PAL	£1125.00	£1350.00
900 x 900	Right Hand	860 - 875	DXPDB	DXP9PAR	£1125.00	£1350.00
1200 x 900	Left Hand	1160 - 1175 & 860 - 875	DXPDB	DXP129PAL	£1250.00	£1500.00
1200 x 900	Right Hand	1160 - 1175 & 860 - 875	DXPDB	DXP129PAR	£1250.00	£1500.00

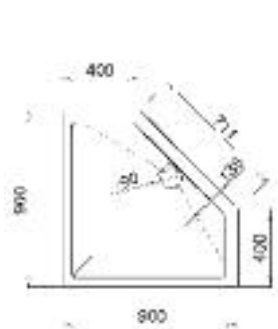

DNT9

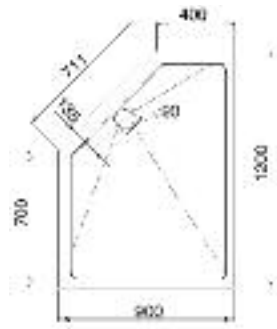

DNT129 Left Hand



DNT129 Right Hand

For full tray details please see page 122

Compatible Trays:	Page
Neo-Angle Trays	122
Roman Shield System	114 - 116

Neo Angle Enclosure

The ingenious angled design of the enclosure will work around existing fixtures and fittings, to fit flawlessly into your bathroom space. Its stylish chromed brass self-closing hinges present an exceptionally smooth door action. The outward opening doors offer wide and comfortable access and feature a design statement square handle and hardware.

10mm



900 x 900 Neo Angle

- Neo-Angle Door DXPDB
- Neo-Angle Panels DXP9PAL
- Neo-Angle Shower Tray DNT9
- Shower Basket RSB02

10mm

Angled Walk-In

Create an extraordinary bathroom design with our Angled Walk-in. Available as a corner, alcove or straight wall installation. Compatible low level tray with integrated drying area or install straight to floor for a sweeping wetroom. Whilst fitting the space of an existing bath (1700mm x 1700mm) the tray uses the space in the middle of the room up to 1 metre deep to offer a huge active showering area.



SNWC Angled Walk-In

- Angled Walk-in with Side Panel SNWC
- Tray SNW1710/L
- Shower Basket RSB01

Features and Benefits:

- 10mm glass
- 1950mm high
+ 55mm if installed to dedicated Walk-in Tray
- Bright silver frame
- 10mm of adjustment in each profile
- 4 configurations to choose from
- Enclosure Reversible for Left or Right hand installation

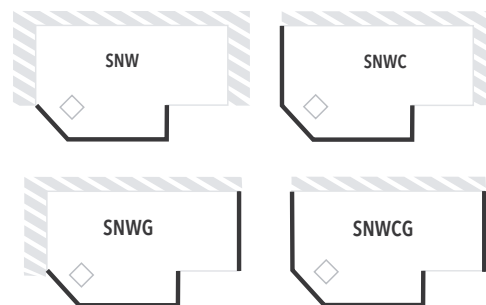

Code	Angled Walk-In Description	Size (mm)	Aperture (mm)	£ ex vat	£ inc vat
SNW	Alcove	1700 x 700	533	£772.17	£926.60
SNWC	With corner panel	1700 x 700	533	£916.73	£1100.08
SNWG	With end panel	1700 x 700	533	£916.73	£1100.08
SNWCG	With corner panel & end panel	1700 x 700	533	£1061.73	£1274.08

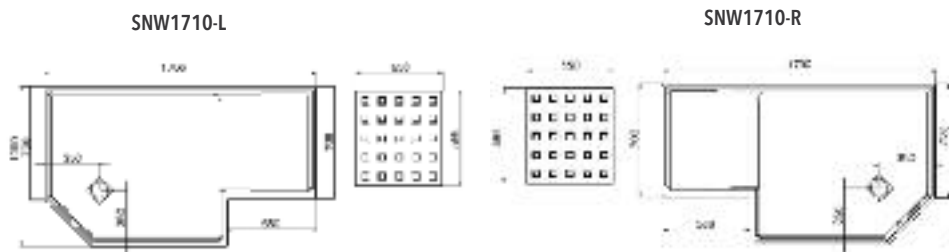

Code	Tray Description	Size	£ ex vat	£ inc vat
SNW1710-L	Angled Walk-In Left Hand Tray	1700 x 800mm	£350.00	£420.00
SNW1710-R	Angled Walk-In Right Hand Tray	1700 x 800mm	£350.00	£420.00

Features and Benefits:

- 10mm glass
- 1950mm high
+ 55mm if installed to dedicated Walk-in Tray
- Bright silver frame
- 10mm of adjustment in each profile
- 4 configurations to choose from
- Reversible for Left or Right hand installation

Code	1700 Walk-In Description	Size (mm)	Aperture (mm)	£ ex vat	£ inc vat
SN	Alcove fitting	1700 x 800	616	£550.44	£660.53
SNG	Corner fitting with side panel	1700 x 800	585	£688.04	£825.65

SN178-L

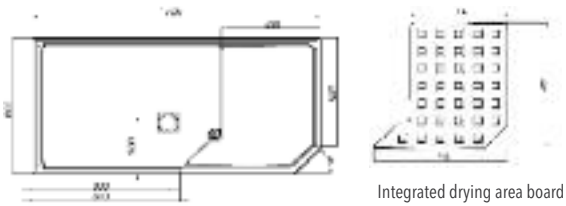

Integrated drying area board

SN178-R

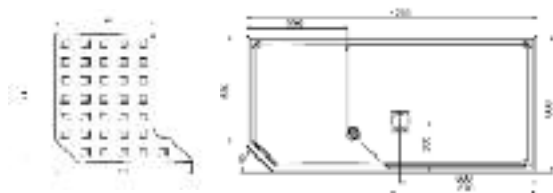

Integrated drying area board

Code	Tray Description	Size	£ ex vat	£ inc vat
SN178-L	Walk-In Left Hand Tray	1700 x 800mm	£320.83	£385.00
SN178-R	Walk-In Right Hand Tray	1700 x 800mm	£320.83	£385.00

1700 Walk-In

Create a dramatic showering space with our Decem Walk-in. Perfect as a bath replacement (the narrower end is below 700mm) or to exquisitely fill a larger bathroom. Offering door-less entry for effortless showering. Install to our Walk-in low level tray with integrated drying area or straight to floor.

10mm



Corner Fitting

- Walk-in Enclosure with Side Panel SNG
- Walk-In Tray SN178L
- Shower Basket RSB01



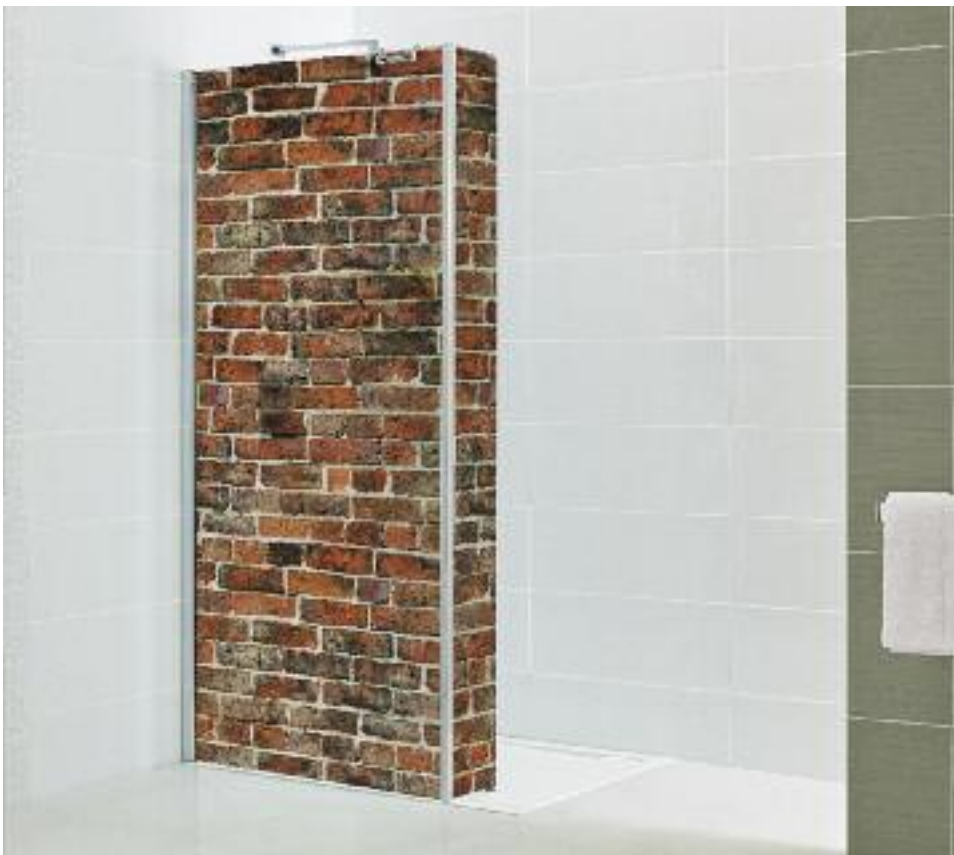

Decem^x Expressions

Contemporary open plan showering

10mm

Expressions encompasses a collection of opulent open plan showering options, which stand at 2000mm high with luxury 10mm thick glass. The glass panels offer the option of either a minimalist concealed fix wall profile or a contemporary exposed fix wall profile. They can be accompanied with a fixed deflector panel to increase water integrity and can be installed onto a low level shower tray or straight to floor.

Printed glass technology

In the collection there are also different glass options available including clear or printed glass, using a printed glass technology exclusive to Roman. These panels are supplied with the exposed wall profile and optional brace bar.

A significant innovation in digital glass printing on glass panels – it is an exclusive technology to Roman.

This breakthrough has been achieved due to a collaboration of technologies with digital print specialists Dimax.

Unlike all current printed glass this new technology allows any images to be printed directly on to the glass, whilst all other areas of the glass remain transparent and crystal clear. The colours are directly printed on to the glass; this is done with a specific thermo-procedure.

This unique digital printing process also provides the option of a Satinato finish, which was not digitally possible before. Roman can control the colour and level of opaqueness desired on the glass design.

Importantly this exclusive digital glass printing is both water resistant and protected against abrasion, which makes it ideal to use in the bathroom.

Decem Expressions with three glass design options – Distressed Brick; Glass Block; and a Rainforest image which all carry a lifetime guarantee.



1200 Corner Panel with with Return Panel

- Corner Panel DXFCP12
- 'L' Return Panel DXFCPL2
- Roman Shield Wetroom System
- Shower Basket RSB05

Features and Benefits:

- 10mm glass
- Glass Height - 2000mm (2030mm with brace bar)
- Surface mounted profile
- Bracing bar for optional usage supplied as standard
- Suitable for installation onto tray or wetroom floor
- Roman Ultra Care glass protection included
- Optional 'L' shaped return panel
- Reversible for left or right hand fitting



Corner Panel with Exposed Wall Profile and optional 'L' Return Panel

This minimalist piece will instantly create a boutique showering space. It provides effortless entry with sweeping door-less and level entry access. A return panel can be incorporated to add to the style and functionality of the wetroom.

10mm



1200 Corner Panel with Return Panel

- Corner Panel DXFCP8
- 'L' Return Panel DXFCPL2
- Gloss Infinity Tray IAG129
- Shower Basket RSB01



1200 Corner Panel

- Corner Panel DXFCP12
- Gloss Infinity Tray IAG129
- Shower Basket RSB05

Corner Panel with Exposed Wall Profile

Panel Size (mm)	Style	Fitting Type	Adjustment (mm)	Order Code required:	Cost ex VAT	Cost inc VAT
800	Corner Panel	Exposed	765 - 780	DXFCP8	£415.62	£498.74
900	Corner Panel	Exposed	865 - 880	DXFCP9	£437.50	£525.00
1000	Corner Panel	Exposed	965 - 980	DXFCP10	£542.50	£651.00
1200	Corner Panel	Exposed	1165 - 1180	DXFCP12	£573.12	£687.74
240	'L' Return Panel	-	+25 to above	DXFCPL2	£218.75	£262.50
440	'L' Return Panel	-	+25 to above	DXFCPL4	£262.50	£315.00

Compatible Trays:	Page
Infinity Trays	119 - 120
Anti-Slip Trays	121
Roman Low Level Trays	125 - 126
Roman Shield System	114 - 116



- 1200 Corner Panel with Return Panel**
- Corner Panel DXFCP12CF
 - 'L' Return Panel DXFCPL2
 - Roman Shield Wetroom System
 - Shower Basket RSB05

Features and Benefits:

- 10mm glass
- Glass Height - 2000mm
- Concealed wall profile supplied
- Suitable for installation onto tray or wetroom floor
- Roman Ultra Care glass protection included
- Optional 'L' shaped return panel
- Reversible for left or right hand fitting
- LBBK4590 bracing bar can be ordered if required for additional support



LBBK4590 Brace Bar

Corner Panel with Concealed Wall Profile and optional 'L' Return Panel

The minimalist design of this stunning Wetroom Panel is truly captured with its concealed wall profile, creating a floating glass effect. Keep the design simple yet stylish by installing the panel onto a low level shower tray or straight to floor for completely level access.

10mm



1200 Corner Panel

- Corner Panel DXFCP12CF
- Gloss Infinity Tray IAG129
- Shower Basket RSB05



1200 Corner Panel with Return Panel

- Corner Panel DXFCP8CF
- 'L' Return Panel DXFCPL2
- Gloss Infinity Tray IAG129
- Shower Basket RSB01

Corner Panel with Concealed Wall Profile

Panel Size (mm)	Style	Fitting Type	Adjustment (mm)	Order Code required:	Cost ex VAT	Cost inc VAT
800	Corner Panel	Concealed	722 - 740	DXFCP8CF	£328.13	£393.76
900	Corner Panel	Concealed	822 - 840	DXFCP9CF	£354.38	£425.26
1000	Corner Panel	Concealed	922 - 940	DXFCP10CF	£455.00	£546.00
1200	Corner Panel	Concealed	1122 - 1140	DXFCP12CF	£485.63	£582.76
230	'L' Return Panel	-	+17 to above	DXFCPL2	£218.75	£262.50
430	'L' Return Panel	-	+17 to above	DXFCPL4	£262.50	£315.00
1060 (Max)	Bracing Bar	-	Cut to suit	LBBK4590	£82.87	£99.44

Compatible Trays:	Page
Infinity Trays	119 - 120
Anti-Slip Trays	121
Roman Low Level Trays	125 - 126
Roman Shield System	114 - 116



1200 Glass Block Panel

- 1200 Glass Block Panel (left hand) DXFC12GPL
- Gloss Infinity Tray IAG168



900 Brick Panel

- 900 Brick Panel (left hand) DXFC9BPL
- Roman Shower Basket RSB06



900 Rainforest Panel

- 900 Rainforest Panel (left hand) DXFC9RPL
- Roman Shower Basket RSB06

Features and Benefits:

- 10mm glass
- Glass Height - 2000mm
- Decem^x surface mounted profile
- Decem^x bracing bar for optional usage supplied as standard
- Suitable for installation onto tray or wetroom floor
- 15mm of adjustment in each minimal wall profile for easy installation
- Optional 'L' shaped return panel

In order to assure quality, regular Cross Hatch tests (EN1502409, ASTM0870 and AS TM D2247) are conducted and documented to prove the durability of prints. They are warranted to CE Marking: EN12150 and EN14428.

Panel Size (mm)	Style	Fitting Type	Adjustment (mm)	Order Codes:			Cost ex VAT	Cost inc VAT
				Glass Block	Rainforest	Distressed Brick		
800	Corner Panel	Exposed	765 - 780	DXFCP8GP	DXFCP8RP	DXFCP8BP	£561.09	£673.31
900	Corner Panel	Exposed	865 - 880	DXFCP9GP	DXFCP9RP	DXFCP9BP	£590.63	£708.76
1000	Corner Panel	Exposed	965 - 980	DXFCP10GP	DXFCP10RP	DXFCP10BP	£732.38	£878.86
1200	Corner Panel	Exposed	1165 - 1180	DXFCP12GP	DXFCP12RP	DXFCP12BP	£773.71	£928.45
200	'L' Return Panel	-	+25 to above	DXFCPL2GP	DXFCPL2RP	DXFCPL2BP	£262.50	£315.00

Must indicate left or right handing of panel e.g.: DXFCP9GPL or DXFC9GPR

Project Applications

Roman has initially launched Decem^x Expressions printed panels with three glass design options - Glass Block; Rainforest and Distressed Brick. Whilst these three are on 'trend' and designated for the higher end of the interior design led retail bathroom market, the process lends itself perfectly for the Project market. Designers can now easily link up other design themes through a Project directly onto a larger and visible position within the bathroom via the glass and there are no restrictions on colour or resolution.



Glass Block



Rainforest



Distressed Brick

Decem^x Expressions

Digitally printed panels

10mm



800 Brick Panel with Return Panel

- 800mm Distressed Brick Panel (left hand) DXFCP8BPL
- L Return Panel DXFCPL2BP
- Gloss Infinity Tray IAG129

Compatible Trays:	Page
Infinity Trays	119 - 120
Anti-Slip Trays	121
Roman Low Level Trays	125 - 126
Roman Shield System	114 - 116



1200 x 900 Corner Fitting

- Hinged Door with One In-Line Panel with Brushed Nickel hardware KL1HDR13N, KL1HR1213N, KHR913N
- Gloss Infinity Tray IAG129
- Shower Basket RSB02



Liber8

Frameless Hinged Collection

The Liber8 Collection is freed from the shackles of traditional bathroom design, with its ultra-modern and minimalist focus.

This exceptional selection of frameless hinged door products presents an array of sizes and configurations to fit in with most bathroom layouts.

The striking minimalist look is captured with options such as door hinged straight from wall with clear seals.

The hinged door or in-line panel can be tailored to suit your specific bathroom layout. It can be installed to open outwards into the bathroom or inwards into the enclosure itself.

This modern collection features a unique wall profile sealing tape system technology, to increase water integrity, whilst also keeping with the minimalist design.

This leading collection of design led shower enclosures is perfectly completed with frame finish options of bright silver chrome, brushed nickel or matt black finish on all components.

Liber8

8mm



900 x 900 Corner Fitting

- Hinged Door for Corner with Chrome finish KL913CS and KR913S
- Roman Low Level Tray RLT90
- Shower Basket RSB01

Features and Benefits:

- 8mm glass
- 2000mm high
- Hinged from wall
- New clear and minimal seals
- New minimal easy fix wall profile system
- Choice of colour finishes for hardware
- Unique sealing tape system technology to reduce the need for silicone
- Integrated 'tray or floor' Water Safe System
- Designed for installation to straight vertical walls

Colour options for handle and hinges



For **Chrome** finish add **S** to order code
 For **Brushed Nickel** finish add **N** to order code
 For **Matt Black** finish add **B** to order code



Brushed Nickel finish

Corner fitting

Description	Size (mm)	Adjustment (mm)	Aperture (mm)	Order Code:	£ ex vat	£ inc vat
Hinged Door for Corner	760	0	720	KL7613C	£484.32	£581.18
Hinged Door for Corner	800	0	760	KL813C	£492.18	£590.62
Hinged Door for Corner	900	0	860	KL913C	£500.06	£600.07
Hinged Door for Corner	1000	0	960	KL1013C	£507.94	£609.53
Side Panel	760	733 - 747		KR7613	£484.32	£581.18
Side Panel	800	773 - 787		KR813	£492.18	£590.62
Side Panel	900	873 - 887		KR913	£500.06	£600.07
Side Panel	1000	973 - 987		KR1013	£507.94	£609.53

N.B. Add preferred colour finish letter to order code

Compatible Trays:	Page
Infinity Trays	119 - 120
Anti-Slip Trays	121
Roman Low Level Trays	125 - 126
Roman Shield System	114 - 116

Hinged Door with Side Panel

8mm

Style your bathroom with a statement frameless shower enclosure from the Liber8 Collection. It is installed with an outward opening door. It presents you with the choice of a brushed nickel, silver chrome or matt black finish on all components including the elongated sleek hinges, designer handle and bracing bar.



Brushed Nickel finish

900 x 900 Corner Fitting

- Hinged Door for Corner with Chrome finish KL913CS and KR913S
- Roman Low Level Tray RLT90
- Shower Basket RSB01



1000 Alcove Fitting

- Hinged Door with One In-Line Panel with Brushed Nickel hardware KL1HD13N, KL1H1013N
- Roman Low Level Tray RLT108
- Shower Basket RSB02

Features and Benefits:

- 8mm glass
- 2000mm high
- Hinged from wall
- New clear and minimal seals
- New minimal easy fix wall profile system
- Adjustable hinges for Inward or Outward opening door
- Choice of colour finishes for hardware
- Unique sealing tape system technology to reduce the need for silicone
- Integrated 'tray or floor' Water Safe System
- Designed for installation to straight vertical walls

Colour options for handle and hinges



For **Chrome** finish add **S** to order code
 For **Brushed Nickel** finish add **N** to order code
 For **Matt Black** finish add **B** to order code



Hinged Door with One In-Line Panel

Keep your bathroom at the forefront of fashion with the luxurious Liber8 Collection. With its sleek minimal look achieved by the doors being hinged straight from wall, optically clear seals and designer led components – it will add an ultra-modern look to your bathroom.



Alcove Fitting

Door Size (mm)	Adjustments (mm)	Aperture (mm)	Order Codes Door	In-Line Panel	Total Cost £ ex vat	Total Cost £ inc vat
760	733 - 747	500	KL1HD213	KL1H7613	£728.88	£874.66
800	773 - 787	500	KL1HD213	KL1H813	£736.31	£883.57
900	873 - 887	640	KL1HD13	KL1H913	£743.75	£892.50
1000	973 - 987	640	KL1HD13	KL1H1013	£818.13	£981.76
1200	1173 - 1187	640	KL1HD13	KL1H1213	£892.50	£1071.00
1400	1373 - 1389	640	KL1HD13	KL1H1413	£966.88	£1160.26
1600	1573 - 1587	640	KL1HD13	KL1H1613	£1041.25	£1249.50

Corner Fitting

Enclosure Size (mm)	Adjustments (mm)	Aperture (mm)	Order Codes Door	In-Line Panel	Side Panel	Total Cost £ ex vat	Total Cost £ inc vat
1000 x 800	773 - 787	667	KL1HDR13	KL1HR1013	KHR813	£1141.86	£1370.23
1000 x 900	873 - 887	667	KL1HDR13	KL1HR1013	KHR913	£1181.25	£1417.50
1200 x 800	773 - 787	667	KL1HDR13	KL1HR1213	KHR813	£1259.98	£1511.98
1200 x 900	873 - 887	667	KL1HDR13	KL1HR1213	KHR913	£1299.37	£1559.24
1400 x 800	773 - 787	667	KL1HDR13	KL1HR1413	KHR813	£1299.37	£1559.24
1400 x 900	873 - 887	667	KL1HDR13	KL1HR1413	KHR913	£1338.76	£1606.51
1600 x 800	773 - 787	667	KL1HDR13	KL1HR1613	KHR813	£1417.49	£1700.99
1600 x 900	873 - 887	667	KL1HDR13	KL1HR1613	KHR913	£1456.88	£1748.26

N.B. Add preferred colour finish letter to order code

1200 x 900 Corner Fitting

- Hinged Door with One In-Line Panel with Brushed Nickel hardware KL1HDR13N, KL1HR1213N, KHR913N
- Gloss Infinity Tray IAG129
- Shower Basket RSB02

Compatible Trays:	Page
Infinity Trays	119 - 120
Anti-Slip Trays	121
Roman Low Level Trays	125 - 126
Roman Shield System	114 - 116

1600 x 800 Corner Fitting

- Hinged Door with Two In-Line Panels with Chrome hardware KLHDR13S, KLHR1613S, KHR813S
- Gloss Infinity Tray IAG168
- Shower Basket RSB01



Features and Benefits:

- 8mm glass
- 2000mm high
- Hinged from In-Line Panel
- New clear and minimal seals
- New minimal easy fix wall profile system
- Adjustable hinges for Inward or Outward opening door
- Choice of colour finishes for hardware
- Unique sealing tape system technology to reduce the need for silicone
- Integrated 'tray or floor' Water Safe System
- Designed for installation to straight vertical walls

Colour options for handle and hinges



For **Chrome** finish add **S** to order code
 For **Brushed Nickel** finish add **N** to order code
 For **Matt Black** finish add **B** to order code

Corner fitting

Enclosure Size (mm)	Adjustments (mm)		Aperture (mm)	Order Codes			Total Cost £ ex vat	Total Cost £ inc vat
	Door and In-Line	Side Panel		Door	In-line Panel	Side Panel		
1200 x 800	1173 - 1187	773 - 787	653	KLHDR13	KLHR1213	KHR813	£1259.98	£1511.98
1200 x 900	1173 - 1187	873 - 887	653	KLHDR13	KLHR1213	KHR913	£1299.37	£1559.24
1400 x 800	1373 - 1387	773 - 787	653	KLHDR13	KLHR1413	KHR813	£1299.37	£1559.24
1400 x 900	1373 - 1387	873 - 887	653	KLHDR13	KLHR1413	KHR913	£1338.76	£1606.51
1600 x 800	1573 - 1587	773 - 787	653	KLHDR13	KLHR1613	KHR813	£1417.49	£1700.99
1600 x 900	1573 - 1587	873 - 887	653	KLHDR13	KLHR1613	KHR913	£1456.88	£1748.26

Alcove fitting

Enclosure Size (mm)	Adjustments (mm)	Aperture (mm)	Order Codes		Total Cost £ ex vat	Total Cost £ inc vat
			Door	In-Line Panel		
1200	1166 - 1194	653	KLHD13	KLH1213	£892.50	£1071.00
1400	1366 - 1394	653	KLHD13	KLH1413	£966.88	£1160.26
1600	1566 - 1594	653	KLHD13	KLH1613	£1041.25	£1249.50

N.B. Add preferred colour finish letter to order code

Compatible Trays:	Page
Infinity Trays	119 - 120
Anti-Slip Trays	121
Roman Low Level Trays	125 - 126
Roman Shield System	114 - 116

Hinged Door with Two In-Line Panels

Cleverly use the alcove space in your bathroom with the frameless hinged door with two in-line panels. The addition of this frameless designed enclosure will bring a cutting-edge look into your open and free bathroom space.



1600 x 800 Alcove Fitting

- Hinged Door with Two In-Line Panels with Chrome hardware KLHD13S, KLH1613S
- Gloss Infinity Tray IAG168
- Shower Basket RSB01



1200 x 900 Corner Fitting

- Hinged Door with In-Line Panel KL2HDR13B, KL2HR1213B, K1R913B with Matt Black hardware
- Black Shimmer Infinity Tray IAG129B
- Shower Basket RSB03

Features and Benefits:

- 8mm glass
- 2000mm high
- Hinged from In-Line Panel
- New clear and minimal seals
- New minimal easy fix wall profile system
- Choice of colour finishes for hardware
- Unique sealing tape system technology to reduce the need for silicone
- Integrated 'tray or floor' Water Safe System
- Designed for installation to straight vertical walls
- Outward opening only

Colour options for handle and hinges



Matt Black finish

Corner Fitting

Enclosure Size (mm)	Adjustment (mm)		Aperture (mm)	Order Codes			Total Cost £ ex vat	Total Cost £ inc vat
	Door and In-Line	Side Panel		Door	In-line Panel	Side Panel		
1000 x 760	973 - 987	733 - 747	760	KL2HDR13	KL2HR1013	K1R7613	£1102.51	£1323.01
1000 x 800	973 - 987	773 - 787	760	KL2HDR13	KL2HR1013	K1R813	£1141.89	£1370.27
1000 x 900	973 - 987	873 - 887	760	KL2HDR13	KL2HR1013	K1R913	£1181.26	£1417.51
1000 x 1000	973 - 987	973 - 987	760	KL2HDR13	KL2HR1013	K1R1013	£1260.02	£1512.02
1200 x 760	1173 - 1187	733 - 747	760	KL2HDR13	KL2HR1213	K1R7613	£1220.63	£1464.76
1200 x 800	1173 - 1187	773 - 787	760	KL2HDR13	KL2HR1213	K1R813	£1260.01	£1512.01
1200 x 900	1173 - 1187	873 - 887	760	KL2HDR13	KL2HR1213	K1R913	£1299.38	£1559.26
1200 x 1000	1173 - 1187	973 - 987	760	KL2HDR13	KL2HR1213	K1R1013	£1378.14	£1653.77

N.B. Add preferred colour finish letter to order code

Compatible Trays:	Page
Infinity Trays	119 - 120
Anti-Slip Trays	121
Roman Low Level Trays	125 - 126
Roman Shield System	114 - 116

Hinged Door with Hinged In-Line Panel

Introduce the Liber8 outward opening hinged door to your bathroom space, to add an enclosure that leads the way in modern design and practicality. Choose the finish that best complements your bathroom décor with the option of bright silver chrome, warm brushed nickel or matt black finishes.



1200 x 900 Corner Fitting

- Hinged Door with In-Line Panel KL2HDR13S, KL2HR1213S, K1R913S with Chrome hardware
- Black Shimmer Infinity Tray IAG129B
- Shower Basket RS802





1200 x 900 Corner Fitting

- Door NF1HDR13S
- Side Panel NHR913S
- In-Line Panel N1HR1213S
- Anti-Slip Tray RST129

See page 54 for more details



New launch in 2017

Innov8

Frameless Pivoting Collection

The Innov8 Collection encompasses elegantly minimalist frameless Pivot Door Enclosures. These frameless enclosures lead the way in minimal, inclusive and stylish design trends, presenting a distinctively modern collection.

Innov8's outstanding differential is the low threshold (reduced height of the bottom rail), allowing level entry access into the shower enclosure.

The elimination of the top rail and profiles (when configured with a side or in-line panel) and the low threshold, encapsulates the minimalist styling, whilst still retaining the water integrity and adjustments of a 'standard' shower enclosure.

Inclusive design is a leading feature in this collection with its level access, elimination of the top rail, which offers flexibility with no height restrictions and a contemporary ergonomic handle.

Different configurations and sizes can be achieved with this collection and the pivot door can be installed to open inwards or outwards.

Innov8

8mm



900 x 900 Corner Fitting

- Door NF913CS
- Side Panel NR913S
- Roman Low Level Tray RLT9
- Shower Basket RSB07

Features and Benefits:

- 8mm glass
- 1950mm high
- Bright Silver frame
- Chromed brass machined components
- Chromed brass feature handle
- Low profile PVC seals
- 25mm of adjustment in each profile
- No top rail
- Alcove and corner options
- Can be installed for inward or outward opening
- Full length pivoting tube
- Reversible for left or right hand fitting
- Side Panels supplied with optional bracing

Corner fitting

Size (mm)	Description	Adjustment (mm)	Door Aperture (mm)	Order Code Required:	Total Cost ex VAT	Total Cost inc VAT
760	Door	710 - 735	610	NF7613CS	£415.40	£498.48
800	Door	750 - 775	650	NF813CS	£415.40	£498.48
900	Door	850 - 875	750	NF913CS	£447.77	£537.32
760	Side Panel	710 - 735	-	NR7613S	£268.82	£322.58
800	Side Panel	750 - 775	-	NR813S	£268.82	£322.58
900	Side Panel	850 - 875	-	NR913S	£290.98	£349.18

Alcove fitting

Size (mm)	Description	Adjustment (mm)	Door Aperture (mm)	Order Code Required:	Total Cost ex VAT	Total Cost inc VAT
760	Door	700 - 750	550	NF7613S	£415.40	£498.48
800	Door	740 - 790	590	NF813S	£415.40	£498.48
900	Door	840 - 890	690	NF913S	£447.77	£537.32

Compatible Trays:	Page
Infinity Trays	119 - 120
Anti-Slip Trays	121
Roman Low Level Trays	125 - 126
Roman Shield System	114 - 116

Pivot Door

A minimalist design with its frameless look presenting inclusivity for all users with its low threshold. Various sizes and configurations are available and the pivot door can be installed to open inwards or outwards, depending on the bathroom space and existing furniture. There is no top rail on the Innov8 Enclosures, which offers the flexibility of no height restriction. Finishing touches include the subtle bright silver frame and stylish handle.



900 Alcove Fitting

- Door NF913S
- Roman Low Level Tray RLT9
- Shower Basket RSB07

1200 Alcove Fitting

- Door NF1HD13S
- In-Line Panel N1H1213S
- Anti Slip Tray RST129
- Shower Basket RSB02



Features and Benefits:

- 8mm glass
- 1950mm high
- Bright Silver frame
- Chromed brass machined components
- Chromed brass feature handle
- Low profile PVC seals
- 25mm of adjustment in each profile
- No top rail
- Alcove and corner options
- Can be installed for inward or outward opening
- Full length pivoting tube
- Reversible for left or right hand fitting
- In-Line Panels supplied with optional bracing

Corner fitting

Enclosure Size (mm)	Adjustment(mm)		Door Aperture (mm)	Order Codes Required:			Total Cost ex VAT	Total Cost inc VAT
	Door and In-Line	Side Panel		Door	Side Panel	In-Line Panel		
1000 x 800	950 - 975	750 - 775	650	NF1HDR13S	NHR813S	N1HR1013S	£885.88	£1063.05
1000 x 900	950 - 975	850 - 875	650	NF1HDR13S	NHR913S	N1HR1013S	£908.04	£1089.65
1200 x 800	1150 - 1175	750 - 775	650	NF1HDR13S	NHR813S	N1HR1213S	£921.22	£1105.46
1200 x 900	1150 - 1175	850 - 815	650	NF1HDR13S	NHR913S	N1HR1213S	£943.38	£1132.06
1400 x 800	1350 - 1325	750 - 775	650	NF1HDR13S	NHR813S	N1HR1413S	£957.22	£1148.66
1400 x 900	1350 - 1375	850 - 875	650	NF1HDR13S	NHR913S	N1HR1413S	£979.38	£1175.26
1500 x 800	1450 - 1475	750 - 775	650	NF1HDR13S	NHR813S	N1HR1513S	£993.22	£1191.86
1500 x 900	1450 - 1475	850 - 875	650	NF1HDR13S	NHR913S	N1HR1513S	£1015.38	£1218.46

Alcove fitting

Enclosure Size (mm)	Adjustment (mm)	Door Aperture (mm)	Order Codes Required:		Total Cost ex VAT	Total Cost inc VAT
			Door	In-Line Panel		
1000	940 - 990	650	NF1HD13S	N1H1013S	£617.06	£740.47
1200	1140 - 1190	650	NF1HD13S	N1H1213S	£652.40	£782.88
1400	1340 - 1390	650	NF1HD13S	N1H1413S	£688.40	£826.08
1500	1440 - 1490	650	NF1HD13S	N1H1513S	£724.40	£869.28

Compatible Trays:	Page
Infinity Trays	119 - 120
Anti-Slip Trays	121
Roman Low Level Trays	125 - 126
Roman Shield System	114 - 116

Pivot Door with In-Line Panel

This frameless Pivot Door with In-Line Panel introduces a distinctive minimalist look, inclusive design and supreme functionality. The contemporary enclosure incorporates a low threshold for effortless level access, providing inclusivity for all users. There are no height restrictions for the user with this enclosure as the top rail has been eliminated. Depending on your preference and bathroom layout, the hinged door can be installed to open inwards or outwards.



1200 x 900 Corner Fitting

- Door NF1HDR13S
- Side Panel NHR913S
- In-Line Panel N1HR1213S
- Anti-Slip Tray RST129
- Shower Basket RSB02



- Showering position**
- Wave Curved Walk-in V8SPC13S
 - Shower Tray V8STL
 - Shower Basket RSB06

See pages 79 - 80 for more details



Lumin8

Semi-Frameless Collection

This compelling and contemporary collection of showering solutions meets all your requirements, whilst bringing an inviting touch of luxury into your bathroom and helping to illuminate your showering experience.

Meticulously designed to solve a variety of space restrictions in the bathroom, whilst providing an effortless showering experience for the whole family. A collection of intricately designed power shower approved bath screens and walk-in enclosures. The diversity of designs and sizes available provides something for every bathroom.

Detail is fundamental with the Lumin8 range to create a unique style with the highest quality. From the individual 'wrap around' chromed top caps, to the robust 8mm thick glass. From the pre-coated glass protection, to the elegant height of 1950mm. From the clear, low profile seals, to the bright silver profiles for a modern finish. Smooth running 'quick release' roller bearings provide easy access cleaning.

We have handpicked the finest materials to craft exceptional products, to provide an exclusive showering experience.

Lumin8

8mm



900 x 1200 Curved Quadrant

- One Door Offset Quadrant V8S091213S
- Roman Low Level Tray RLO129R (Right Hand)
- Shower Basket RSB02

Features and Benefits:

- 8mm glass
- 1950mm high
- Chromed brass handle
- Bright silver frame
- 'Minimal' low profile seals
- Smooth running 'quick release' roller bearings
- 25mm vertical adjustment in each profile
- Full reversible for left or right hand installation
- Tray Compatibility: Tray or straight to floor using Roman Shield Wetroom System



NB: Offset size enclosures - door always sits on curved/short edge of tray as illustrated.

900 x 1200 Curved Quadrant

- One Door Offset Quadrant V8SQ91213S
- Roman Low Level Tray RLQ129L (Left Hand)
- Shower Basket RSB02

Code	Description	Size (mm)	Aperture (mm)	Adjustments (mm)	£ ex vat	£ inc vat
V8SQ813S	One Door Quadrant	800 x 800	425	750 - 775	£660.00	£792.00
V8SQ913S	One Door Quadrant	900 x 900	525	850 - 875	£660.00	£792.00
V8SQ8913S	One Door Offset Quadrant	800 x 900	425	750 - 775 & 850 - 875	£660.00	£792.00
V8SQ81013S	One Door Offset Quadrant	800 x 1000	425	750 - 775 & 950 - 975	£779.16	£934.99
V8SQ81213S	One Door Offset Quadrant	800 x 1200	425	750 - 775 & 1150 - 1175	£815.84	£979.01
V8SQ91213S	One Door Offset Quadrant	900 x 1200	525	850 - 875 & 1150 - 1175	£852.50	£1023.00

Compatible Trays:	Page
Infinity Trays	119 - 120
Roman Low Level Trays	125 - 126
Roman Shield System	114 - 116



One Door Quadrant

An ideal solution for smaller bathrooms as it will sit beautifully in the corner of your bathroom, with an unobtrusive sliding door. A 'quick release' door system is included for easy access cleaning. Also available in an offset shape for a larger showering area where space allows.



900 x 900 Curved Quadrant

- One Door Quadrant V8SQ913S
- Roman Low Level Tray RLQ90
- Shower Basket RSB02



900 x 900 Curved Quadrant

- Two Door Quadrant V8Q913S
- Roman Low Level Tray RLQ9
- Shower Basket RSB02



Features and Benefits:

- 8mm glass
- 1950mm high
- Chromed brass handles
- Bright silver frame
- 'Minimal' low profile seals
- Smooth running 'quick release' roller bearings
- 25mm vertical adjustment in each profile
- Full reversible for left or right hand installation
- Tray Compatibility: Tray or straight to floor using Roman Shield Wetroom System

Code	Description	Size (mm)	Aperture (mm)	Adjustments (mm)	£ ex vat	£ inc vat
V8Q813S	Two Door Quadrant	800 x 800	330	750 - 775	£586.66	£703.99
V8Q8913S	Two Door Offset Quadrant	800 x 900	420	750 - 775 & 850 - 875	£586.66	£703.99
V8Q913S	Two Door Quadrant	900 x 900	500	850 - 875	£586.66	£703.99
V8Q81013S	Two Door Offset Quadrant	800 x 1000	420	750 - 775 & 950 - 975	£623.34	£748.01
V8Q81213S	Two Door Offset Quadrant	800 x 1200	420	750 - 775 & 1150 - 1175	£660.00	£792.00
V8Q91213S	Two Door Offset Quadrant	900 x 1200	510	850 - 875 & 1150 - 1175	£696.66	£835.99

Compatible Trays:	Page
Infinity Trays	119 - 120
Roman Low Level Trays	125 - 126
Roman Shield System	114 - 116

Two Door Quadrant

The two sliding doors are an intelligent space saving tactic, as they allow access to the centre of the curve, whilst offering an indulgent showering area. 'Quick release' door system for easy cleaning access is included and it is also available in an offset shape for a larger showering area where space allows.



900 x 1200 Offset Curved Quadrant

- Two Door Offset Quadrant V8Q91213S
- Roman Low Level Tray RLQ129R (Right Hand)
- Shower Basket RSB07

NB: Offset size enclosures - doors always sit on curved/short edge of tray as illustrated.



1136 x 647 Offset Bow Fronted Quadrant

- Offset Bow Fronted Quadrant V8BQ1113S
- Roman Bow Fronted Tray DOT3R (Right Hand)
- Shower Basket RSB06

Features and Benefits:

- 8mm glass
- 1950mm high
- Chromed brass handle
- Bright silver frame
- 'Minimal' low profile seals
- Smooth running 'quick release' roller bearings
- 25mm vertical adjustment in each profile
- Chrome top caps
- Tray Compatibility: Suitable for dedicated tray or straight to floor using Roman Shield Wetroom System



Bow Fronted Quadrant



The cleverly shaped Lumin8 Bow Fronted Quadrant will make the most out of your available bathroom space. The sliding door avoids obstruction into the bathroom space and into the showering space, making it ideal for smaller bathrooms. The clever sizing of the DQT3 tray takes up minimal wall space but delivers a showering area of 1200mm x 1000mm.



Code	Description	Size (mm)	Aperture (mm)	Adjustments (mm)	Tray	£ ex vat	£ inc vat
V8BQ813S	Bow Fronted Quadrant	800 x 800	570	840 - 865	DQT8	£820.41	£984.49
V8BQ913S	Bow Fronted Quadrant	900 x 900	650	950 - 975	DQT9	£820.41	£984.49
V8BQ1113S	Offset Bow Fronted Quadrant	1136 x 647	650	950 - 975 & 1185 - 1210	DQT3	£912.09	£1094.51

Compatible Trays:

For full tray information please see page 124.

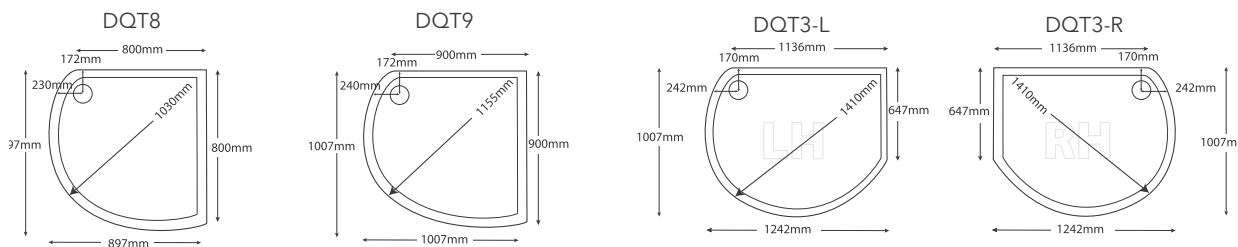

Left or right handing must be specified for DQT3 tray

- 900 x 900 Bow Fronted Quadrant**
- Bow Fronted Quadrant V8BQ913S
 - Roman Bow Fronted Tray DQT9
 - Shower Basket RSB07



1000 Alcove fitting

- Pivot Door V8F1013S
- Roman Low Level Tray RLT100
- Shower Basket RSB06

Features and Benefits:

- 8mm glass
- 1950mm high
- Chromed brass hinges
- Chromed brass handle
- Bright silver frame
- 'Minimal' low profile seals
- Pivot Door must be hinged from the wall
- 25mm vertical adjustment in each profile
- Reversible for right or left hand fixing
- Tray Compatibility: Tray or straight to floor using Roman Shield Wetroom System

Code	Description	Size (mm)	Aperture (mm)	Adjustments (mm)	£ ex vat	£ inc vat
V8F7613S	Pivot Door	760	465	700 - 750	£462.91	£555.49
V8F13S	Pivot Door	800	505	740 - 790	£462.91	£555.49
V8F913S	Pivot Door	900	605	840 - 890	£499.59	£599.51
V8F1013S	Pivot Door	1000	705	940 - 990	£517.91	£621.49
V8GL7613S	Side Panel	760	-	710 - 735	£307.09	£368.51
V8GL813S	Side Panel	800	-	750 - 775	£307.09	£368.51
V8GL913S	Side Panel	900	-	850 - 875	£334.59	£401.51
VZEX2S	Extension Profile	1950 high	-	-	£55.00	£66.00
V8HL213S	In-Line Panel	200	-	+ 200mm to door sizes	£183.34	£220.01
V8HL313S	In-Line Panel	300	-	+ 300mm to door sizes	£201.66	£241.99

Compatible Trays:	Page
Infinity Trays	119 - 120
Roman Low Level Trays	125 - 126
Roman Shield System	114 - 116

Pivot Door

This outward opening door takes up minimal external space due to the positioning of the hinge point, meaning it protrudes less into the bathroom, allowing for the close positioning of bathroom fixtures and fittings. The simplicity of the Pivot Door creates a supremely efficient space saving solution.

8mm



Corner Fitting

- 1000mm Pivot Door V8F1013S and 800mm Side Panel V8GL813S
- Roman Low Level RLT109
- Shower Basket RSB06



1200 Alcove Fitting

- 1000mm Pivot Door V8F1013S with 200mm In-Line Panel V8HL213S
- Gloss Infinity Tray IAG128
- Shower Basket RSB06

Features and Benefits:

- 8mm glass
- 1950mm high
- Chromed brass hinges
- Chromed brass handle
- Bright silver frame
- 'Minimal' low profile seals
- Pivot Door must be hinged from the wall
- 25mm vertical adjustment in each profile
- Reversible for right or left hand fixing
- Tray Compatibility: Tray or straight to floor using Roman Shield Wetroom System

Code	Description	Size (mm)	Aperture (mm)	Adjustments (mm)	£ ex vat	£ inc vat
V8F7613S	Pivot Door	760	465	700 - 750	£462.91	£555.49
V8F13S	Pivot Door	800	505	740 - 790	£462.91	£555.49
V8F913S	Pivot Door	900	605	840 - 890	£499.59	£599.51
V8F1013S	Pivot Door	1000	705	940 - 990	£517.91	£621.49
V8HL213S	In-Line Panel	200	-	+ 200mm to door sizes	£183.34	£220.01
V8HL313S	In-Line Panel	300	-	+ 300mm to door sizes	£201.66	£241.99
V8GL7613S	Side Panel	760	-	710 - 735	£307.09	£368.51
V8GL813S	Side Panel	800	-	750 - 775	£307.09	£368.51
V8GL913S	Side Panel	900	-	850 - 875	£334.59	£401.51
VZEX2S	Extension Profile	1950 high	-	-	£55.00	£66.00

Compatible Trays:	Page
Infinity Trays	119 - 120
Anti-Slip Trays	121
Roman Low Level Trays	125 - 126
Roman Shield System	114 - 116

Pivot Door with In-Line Panel

This outward opening door when used with an In-Line Panel allows a larger enclosure to be created with the simplicity of the Pivot Door which creates a supremely efficient space saving solution. The Pivot Door and In-Line Panel can be installed into an alcove or with a side panel for the corner situation.



1200 x 800 Corner Fitting

- 1000mm Pivot Door V8F1013S with 200mm In-Line Panel V8HL213S and 800mm Side Panel V8GL813S
- Gloss Infinity Tray IAG128
- Shower Basket RSB06



Fully opened position of Inswing Door



1200 Alcove Fitting

- 1200mm Inswing Door V8KH1213S
- Black Shimmer Infinity Tray IAG129B
- Shower Basket RSB02

Features and Benefits:

- 8mm glass
- 1950mm high
- 8mm glass thickness
- Chromed brass hinges
- Chromed brass handle
- Bright silver frame
- Inswing Door must be hinged from the wall
- Reversible for right or left hand fixing
- Tray Compatibility: Tray or straight to floor using Roman Shield Wetroom System

Code	Description	Size (mm)	Aperture (mm)	Adjustments (mm)	£ ex vat	£ inc vat
V8K7613S	Inswing Door	760	540	700-750	£629.17	£755.00
V8K813S	Inswing Door	800	580	740-790	£629.17	£755.00
V8K913S	Inswing Door	900	680	840-890	£670.83	£805.00
V8K1013S	Inswing Door	1000	780	940-990	£716.67	£860.00
V8KH1213S	Inswing Door	1200*	580	1140-1190	£745.83	£895.00
V8GL7613S	Side Panel	760	-	710 - 735	£307.09	£368.51
V8GL813S	Side Panel	800	-	750 - 775	£307.09	£368.51
V8GL913S	Side Panel	900	-	850 - 875	£334.59	£401.51
VZEX2S	Extension Profile	1950 high	-	-	£55.00	£66.00
V8HL213S	In-Line Panel	200	-	+ 200mm to door sizes	£183.34	£220.01
V8HL313S	In-Line Panel	300	-	+ 300mm to door sizes	£201.66	£241.99

In-Line Panels can be used with the Inswing Door

*Please note the 1200mm Inswing Door is a Door/In-Line Panel combination (see image on page 67)

Compatible Trays:	Page
Infinity Trays	119 - 120
Anti-Slip Trays	121
Roman Low Level Trays	125 - 126
Roman Shield System	114 - 116

Inswing Door

This cleverly designed Inswing door features a large opening without significant protrusion into the bathroom space. The unique opening mechanism allows for existing bathroom fixtures and fittings. The stylish look is completed with a bright silver frame, chromed brass machined components (including soft close mechanism) and an elegant feature handle. The 1200mm option eliminates the need for a separate in-line panel as an integrated frameless panel is included.



1000 Corner Fitting

- Inswing Door V8K1013S and 800mm Side Panel V8GL813S
- Roman Low Level Tray RLT108
- Shower Basket RSB02



Alcove Fitting

- 1200mm Sliding Door V8T1213S
- Gloss Infinity Tray IAG128
- Shower Basket RSB06

Features and Benefits:

- 8mm glass
- 1950mm high
- Chromed brass handle
- Bright silver frame
- 'Minimal' low profile seals
- Smooth running 'quick release' roller bearings
- 25mm vertical adjustment in each profile
- Reversible for right or left hand fixing
- Tray Compatibility: Tray or straight to floor using Roman Shield Wetroom System

Code	Description	Size (mm)	Aperture (mm)	Adjustments (mm)	£ ex vat	£ inc vat
V8T1013S	Sliding Door	1000	360	940 - 990	£467.50	£561.00
V8T1113S	Sliding Door	1100	410	1040 - 1090	£485.84	£583.01
V8T1213S	Sliding Door	1200	460	1140 - 1190	£504.16	£604.99
V8T1413S	Sliding Door	1400	560	1340 - 1390	£522.50	£627.00
V8T1513S	Sliding Door	1500	610	1440 - 1490	£528.61	£634.33
V8T1713S	Sliding Door	1700	710	1640 - 1690	£540.84	£649.01
V8GL7613S	Side Panel	760	-	710 - 735	£307.09	£368.51
V8GL813S	Side Panel	800	-	750 - 775	£307.09	£368.51
V8GL913S	Side Panel	900	-	850 - 875	£334.59	£401.51
VZEX2S	Extension Profile	1950 high	-	35mm extra	£55.00	£66.00
V8HL213S	In-Line Panel	200	-	+ 200mm to door sizes	£183.34	£220.01
V8HL313S	In-Line Panel	300	-	+ 300mm to door sizes	£201.66	£241.99

Compatible Trays:	Page
Infinity Trays	119 - 120
Anti-Slip Trays	121
Roman Low Level Trays	125 - 126
Roman Shield System	114 - 116

Sliding Door

The weight of the 8mm thick glass provides a smooth action sliding door, and features a 'quick release' door system for easy cleaning. The Sliding Door offers wide and easy access whilst allowing design flexibility for bathroom furniture and the showering space. It exudes luxury with the effortless door action and generous door opening.



1200 x 800 Corner Fitting

- 1200mm Sliding Door V8T1213S and 800mm Side Panel V8GL813S
- Gloss Infinity Tray IAG128
- Shower Basket RSB06



Alcove Fitting

- Sliding Door V8TLE1213S
- Roman Level Tray RLT128
- Shower Basket RS807

Features and Benefits:

- 8mm glass
- Height: 1900mm
- Frame: Silver
- Optional bottom rail
- Easy release door function
- Compatible with Embrace Side Panels
- Left or Right handing must be specified
- Tray compatibility: Tray or straight to floor using Roman Shield Wetroom System

New launch in 2017

Level Access Sliding Door

Make your bathroom totally inclusive with this sliding door, as the bottom rail can be minimal or completely barrier free, creating true level entry access. The design and functionality exudes luxury with the ultra-smooth running door action, generous door opening, stylish chromed brass components and an elegant feature handle.



Alcove Fitting

- Sliding Door V8TLE1213S
- Roman Low Level Tray RLT128

Code	Description	Size (mm)	Aperture (mm)	Adjustments (mm)	£ ex vat	£ inc vat
V8TLE1013S	Level Access Sliding Door	1000	360	940 - 990	£517.50	£621.00
V8TLE1113S	Level Access Sliding Door	1100	410	1040 - 1090	£535.84	£643.01
V8TLE1213S	Level Access Sliding Door	1200	460	1140 - 1190	£554.16	£664.99
V8TLE1413S	Level Access Sliding Door	1400	560	1340 - 1390	£572.50	£687.00
V8TLE1513S	Level Access Sliding Door	1500	610	1440 - 1490	£578.61	£694.33
V8TLE1713S	Level Access Sliding Door	1700	710	1640 - 1690	£590.84	£709.01

Compatible Trays:	Page
Infinity Trays	119 - 120
Anti-Slip Trays	121
Roman Low Level Trays	125 - 126
Roman Shield System	114 - 116



800 Alcove Fitting

- Bi-Fold Door V8V13S
- Roman Low Level Tray RLT80
- Shower Basket RSB06

Features and Benefits:

- 6mm glass
- 1950mm high
- Chromed brass hinges
- Chromed brass handle
- Bright silver frame
- 25mm vertical adjustment in each profile
- Reversible for right or left hand fixing
- Tray Compatibility: Tray or straight to floor using Roman Shield Wetroom System

Code	Description	Size (mm)	Aperture (mm)	Adjustments (mm)	£ ex vat	£ inc vat
V8V7613S	Bi-Fold Door	760	460	700 - 750	£504.16	£604.99
V8V13S	Bi-Fold Door	800	500	740 - 790	£504.16	£604.99
V8V913S	Bi-Fold Door	900	600	840 - 890	£545.41	£654.49
V8V1013S	Bi-Fold Door	1000	700	940 - 990	£591.25	£709.50
V8V1213S	Bi-Fold Door	1200	900	1140 - 1190	£609.59	£731.51
V8GL7613S	Side Panel	760	-	710 - 735	£307.09	£368.51
V8GL813S	Side Panel	800	-	750 - 775	£307.09	£368.51
V8GL913S	Side Panel	900	-	850 - 875	£334.59	£401.51
VZEX2S	Extension Profile	1950 high	-	35mm extra	£55.00	£66.00
V8HL213S	In-Line Panel	200	-	+ 200mm to door sizes	£183.34	£220.01
V8HL313S	In-Line Panel	300	-	+ 300mm to door sizes	£201.66	£241.99

N.B. 1000 and 1200 door options are one piece fully framed.

Compatible Trays:	Page
Infinity Trays	119 - 120
Anti-Slip Trays	121
Roman Low Level Trays	125 - 126
Roman Shield System	114 - 116

Bi-Fold Door

Practical inward opening doors present an extremely flexible space saving solution. Ideal for use in smaller bathrooms or where there may be obstructions outside the showering area, which need to be avoided. Smooth gliding door action for effortless entry.

6mm



800 x 800 Corner Fitting

- 800mm Bi-Fold Door V8V13S and 800mm Side Panel V8GL813S
- Roman Low Level Tray RL780
- Shower Basket RSB06

1700 Colossus + 2 Side Panels

- 1700mm Colossus with 2 Side Panels V8CGR13S
- Roman Shield Wetroom System
- Shower Basket R5B01

Features and Benefits:

- 8mm glass
- 1950mm high
- Bright silver frame
- 25mm vertical adjustment
- Chrome top caps
- Tray Compatibility: Suitable for dedicated tray or straight to floor using Roman Shield Wetroom System

1700mm Colossus

The Lumin8 Colossus presents a bath replacement enclosure, which occupies the same wall dimensions as a standard UK bath. Its curvaceous nature bows out to create a spacious and indulgent showering space. It imitates a wetroom in its styling, whilst providing more enclosed showering which is preferred in the UK bathroom.



1700mm Colossus with 1 Side Panel V8CG13S. Shower Tray FC1R. Shower Basket RSB01.



Colossus with Return Panel V8CGM13S.



Code	Description	Size (mm)	Aperture (mm)	Adjustments (mm)	Tray	£ ex vat	£ inc vat
V8C13S	Colossus	1700	470	25	FCT	£809.38	£971.26
V8CG13S	Colossus + 1 Side Panel	1700	450	25	FCT	£1010.63	£1212.76
V8CGM13S	Colossus + Return Panel	1700	450	25	FCT	£1010.63	£1212.76
V8CGR13S	Colossus + 2 Side Panels	1700	450	25	FCT	£1211.87	£1454.24

For full tray information please see page 123

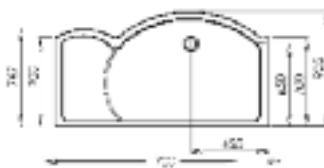

Left Hand Low Level Tray - FC1L

Compatible Trays:	Page
Solid Surface Trays	123
Roman Shield System	114 - 116



Corner Fitting

- 1700mm Colossus V8C13S
- Shower Tray FC1R
- Shower Basket RSB06

1450 Colossus

- 1450mm Colossus V8C213S
- Shower Tray FCT1R
- Shower Basket RSB06



Features and Benefits:

- 8mm glass
- 1950mm high
- Bright silver frame
- 25mm vertical adjustment
- Chrome top caps
- Tray Compatibility: Suitable for dedicated tray or straight to floor using Roman Shield Wetroom System



1450mm Colossus

Whilst the 1750mm Colossus is a direct bath replacement (due to the 700mm wall fixing at each end of the tray) the 1450mm version offers a luxurious curved Walk-in option in and around standard shower enclosure footprints. Due to the curved panel the showering area is maximised at all times.



Code	Description	Size (mm)	Aperture (mm)	Adjustments (mm)	Tray	£ ex vat	£ inc vat
V8C213S	Colossus	1450	465	25	FCT1	£704.38	£845.26
V8CG213S	Colossus + 1 Side Panel	1450	435	25	FCT1	£905.63	£1086.76
V8CGM213S	Colossus + Return Panel	1450	435	25	FCT1	£905.63	£1086.76
V8CGR213S	Colossus + 2 Side Panels	1450	435	25	FCT1	£1106.87	£1328.24

For full tray information please see page 123

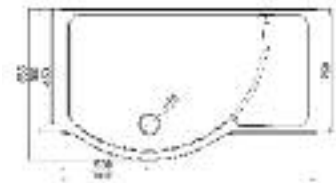

Left Hand Low Level Tray - FCT1L

Compatible Trays:	Page
Solid Surface Trays	123
Roman Shield System	114 - 116



- 1450 Colossus +1 Side Panel**
- 1450mm Colossus + 1 Side Panel V8CG213S
 - Shower Tray FCT1R
 - Shower Basket RSB06



- Showering position**
- Wave Curved Walk-in V8SPC13S
 - Shower Tray V8STL
 - Shower Basket RSB06

Features and Benefits:

- 8mm glass
- 1950mm high
- Bright silver frame
- Fixed Curved Panel
- Inward opening curved moving panel - rotates through 180 degrees
- Optional Chromed brass brace bar included
- Clear PVC bottom seal on deflector panel
- 25mm vertical adjustment
- Chrome top caps
- Tray Compatibility: Suitable for dedicated tray or straight to floor using Roman Shield Wetroom System



Code	Fixed Panel (mm)	Moving Panel (mm)	Size (mm)	Aperture (mm)	Adjustments (mm)	Tray	£ ex vat	£ inc vat
V8SPC13S	740	430	1200	435	25mm	V8ST	£704.37	£845.24
V8SPC1413S	920	430	1400	435	25mm	V8ST14	£809.38	£971.26

Side Panel

Code	Size (mm)	Adjustments (mm)	£ ex vat	£ inc vat
V8CGPA	636mm	25mm	£201.257	£241.50

When used with a Side Panel this creates a wetroom solution but is not an enclosure.

Wave Walk-in

Create a true style statement in your bathroom with our beautiful Lumin8 Curved Walk-in. The curvaceous nature of the Walk-in presents a luxuriously large showering area – and the curved glass which helps to create improved water integrity cleverly stows inside its own curve when not in use. A frameless wetroom panel option is available if used in a corner situation.



V8STL - Left Hand



V8STR - Right Hand



V8ST14L - Left Hand

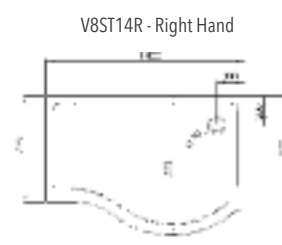

V8ST14R - Right Hand

Stow position

- Wave Curved Walk-in V8SPC13S
- Shower Tray V8STL
- Shower Basket RSB06

Tray handing must be specified - for pricing please see page 123. For Roman Shield Wetroom System pages 114 - 116.



Corner fitting

- Sliding Door ETLE1713S
- Side Panel EGL813S
- Anti Slip Tray RST178
- Shower Basket RSB07

See pages 87 - 88 for more details



Embrace

Semi-Frameless Collection

Imaginative, urbane and innovative showering solutions designed to maximise space.

Our Embrace Collection brings together an innovative and stylish collection of shower enclosures and wetroom panels offering high performance and design benefits at an extremely competitive price.

This exclusive range is available in an array of styles and shapes with bi-fold, hinged, quadrant, pivot, sliding doors and bath screens.

Specifications:

- All models feature exquisite chromed hardware and concealed fittings.
- All enclosures in the range are fully approved for use with power showers.
- Models that feature handle entry, present an elegant ergonomic bolt through handle which can be operated from inside and outside the unit.
- All Embrace enclosures and bath screens are supplied pre-coated with Roman Ultra Care - to aid glass protection from day one.

Embrace

8mm



900 x 1200 One Door Quadrant

- One Door Curved Quadrant ESQ12913S
- Roman Low Level Tray RLQ129R
- Shower Basket RSB02

Features and Benefits:

- 6mm glass
- Height: 1900mm
- Frame: Silver
- Vertical adjustment: 25mm
- Smooth running roller bearings
- Fully reversible for left or right hand fixing
- 'Quick release' system for easy cleaning
- Tray compatibility: 550mm radius



Code	Description	Size (mm)	Aperture (mm)	Adjustments (mm)	£ ex vat	£ inc vat
ESQ813S	One Door	800 x 800	410	760 - 785	£586.25	£703.50
ESQ913S	One Door	900 x 900	505	860 - 885	£586.25	£703.50
ESQ8913S	One Door Offset	800 x 900	505	760 - 785 & 860 - 885	£586.25	£703.50
ESQ81013S	One Door Offset	1000 x 800	495	760 - 785 & 960 - 985	£700.00	£840.00
ESQ81213S	One Door Offset	800 x 1200	470	760 - 785 & 1160 - 1185	£735.00	£882.00
ESQ91213S	One Door Offset	900 x 1200	470	860 - 885 & 1160 - 1185	£770.00	£924.00

Compatible Trays:	Page
Infinity Trays	119 - 120
Roman Low Level Trays	125 - 126
Roman Shield System	114 - 116

One Door Quadrant

The Embrace Quadrant with a single door is a fusion of elegant styling and practical functionality. It is a perfect solution for when space is at a premium and a corner installation is more practical. It is also available in a single door offset version.

6mm



900 x 1200 One Door Quadrant

- One Door Curved Quadrant ESQ12913S
- Roman Low Level Tray RLQ129R
- Shower Basket RSB02

6mm

Two Door Quadrant

The stunning Embrace Quadrant is available in a two door opening version for where central access into the showering area is more practical.

Features and Benefits:

- 6mm glass
- Height: 1900mm
- Frame: Silver
- Vertical adjustment: 50mm
- Smooth running roller bearings
- Reversible for left or right hand fitting
- 'Quick release' system for easy cleaning
- Tray compatibility: 550mm radius



Code	Description	Size (mm)	Aperture (mm)	Adjustments (mm)	£ ex vat	£ inc vat
EQ813S	Twin Door	800 x 800	315	760 - 785	£516.25	£619.50
EQ913S	Twin Door	900 x 900	485	860 - 885	£516.25	£619.50
EQ76913S	Twin Door	760 x 900	400	720 - 745 & 860 - 885	£516.25	£619.50
EQ1013S	Twin Door	1000 x 1000	485	960 - 985	£586.25	£703.50
EQ8913S	Twin Door Offset	800 x 900	405	760 - 785 & 860 - 885	£516.25	£619.50
EQ81013S	Twin Door Offset	800 x 1000	435	760 - 785 & 960 - 985	£551.25	£661.50
EQ81213S	Twin Door Offset	800 x 1200	440	760 - 785 & 1160 - 1185	£586.25	£703.50
EQ91213S	Twin Door Offset	900 x 1200	530	860 - 885 & 1160 - 1185	£621.25	£745.50

900 x 900 Two Door Curved Quadrant

- Two Door Curved Quadrant EQ913S
- Roman Low Level Tray RLQ90
- Shower Basket RSB05

Compatible Trays:	Page
Infinity Trays	119 - 120
Roman Low Level Trays	125 - 126
Roman Shield System	114 - 116

Features and Benefits:

- 6mm glass
- Height: 1900mm
- Frame: Silver
- PVC vertical seals
- Reversible for left or right hand fixing
- Adjustable smooth running bearings
- 'Quick release' mechanism
- Tray compatibility: Tray or straight to floor using Roman Shield Wetroom System



Code	Description	Size (mm)	Aperture (mm)	Adjustments (mm)	£ ex vat	£ inc vat
ET1013S	Sliding Door	1000	350	950 - 1000	£402.50	£483.00
ET1113S	Sliding Door	1100	400	1050 - 1100	£420.00	£504.00
ET1213S	Sliding Door	1200	450	1150 - 1200	£437.50	£525.00
ET1413S	Sliding Door	1400	550	1350 - 1400	£457.50	£549.00
ET1713S	Sliding Door	1700	700	1650 - 1700	£475.83	£571.00

For full range of compatible Embrace Frameless Side Panels and In-Line Panels see page 91.

Compatible Trays:	Page
Infinity Trays	119 - 120
Anti-Slip Trays	121
Roman Low Level Trays	125 - 126
Roman Shield System	114 - 116

1200 Corner Fitting

- Sliding Door ET1213S
- 900mm Frameless Side Panel EGL913S
- Roman Low Level Tray RLT129
- Shower Basket RSB03

Sliding Door

Our opulent Embrace Sliding Door incorporates a showering configuration to suit any bathroom size and shape, presenting an unrivalled specification. The sliding door shower entrance is a key space saving feature.

6mm





- 1200 Alcove fitting**
- Sliding Door ETLE1213S
 - Infinity Shower Tray IA128
 - Shower Basket RSB07



Features and Benefits:

- 6mm glass
- Height: 1900mm
- Frame: Silver
- Optional bottom rail
- Easy release door function
- Compatible with Embrace Side Panels
- Left or Right handing must be specified
- Tray compatibility: Tray or straight to floor using Roman Shield Wetroom System

Level Access Sliding Door

This enclosure is ideal for the whole family with its barrier free bottom rail option, spacious door opening and stylish ergonomic handle. Its design is truly inclusive, whilst maintaining its luxury styling and superb water integrity. The sliding door allows for existing bathroom furniture, making it ideal for small or large bathroom spaces.

6mm

Code	Description	Size (mm)	Aperture (mm)	Adjustments (mm)	£ ex vat	£ inc vat
ETLE1013S	Level Access Sliding Door	1000	350	950 - 1000	£452.50	£543.00
ETLE1113S	Level Access Sliding Door	1100	400	1050 - 1100	£470.00	£564.00
ETLE1213S	Level Access Sliding Door	1200	450	1150 - 1200	£487.50	£585.00
ETLE1413S	Level Access Sliding Door	1400	550	1350 - 1400	£507.50	£609.00
ETLE1713S	Level Access Sliding Door	1700	700	1650 - 1700	£525.83	£631.00

For the full range of compatible Embrace Frameless Side Panels and In-Line Panels see page 92.

Compatible Trays:	Page
Infinity Trays	119 - 120
Anti-Slip Trays	121
Roman Low Level Trays	125 - 126
Roman Shield System	114 - 116



Corner fitting

- Sliding Door ETLE1713S
- Side Panel EGL813S
- Anti Slip Tray RST178
- Shower Basket RSB07

9mm

Hinged Door

The semi frameless design of the Embrace Hinged Door combines strength and versatility to create a perfect showering solution to suit any shape or size bathroom. The versatile adjustments make this shower door perfect for out of true walls.

Features and Benefits:

- 6mm glass
- Height: 1900mm
- Frame: Silver
- Vertical adjustment: 50mm
- Removable top rail when installed in an alcove
- Ball catch closing mechanism
- Outward opening doors must be hinged from the wall
- Reversible for left or right hand fixing
- Tray compatibility: Tray or straight to floor using Roman Shield Wetroom System



900 Alcove fitting

- Hinged Door EL913S
- Roman Low Level Tray RLT90
- Shower Basket RSB05



900 x 900 Corner Fitting

- Hinged Door EL913S
- Frameless Side Panel EGL913S
- Roman Low Level Tray RLT90
- Shower Basket RSB01

Code	Description	Size (mm)	Aperture (mm)	Adjustments (mm)	£ ex vat	£ inc vat
EL7613S	Hinged Door	760	530	710 - 760	£495.21	£594.25
EL13S	Hinged Door	800	570	750 - 800	£495.21	£594.25
EL913S	Hinged Door	900	670	850 - 900	£534.42	£641.30
EL1013S	Hinged Door	1000	770	950 - 1000	£550.27	£660.32

For the full range of compatible Embrace Frameless Side Panels and In-Line Panels see page 92.

Compatible Trays:	Page
Infinity Trays	119 - 120
Anti-Slip Trays	121
Roman Low Level Trays	125 - 126
Roman Shield System	114 - 116

Features and Benefits:

- 6mm glass
- Height: 1900mm
- Frame: Silver
- Magnetic door closing
- PVC vertical seals
- Reversible for left or right hand fixing
- Reduced opening into room due to hinge position
- Outward opening doors must be hinged from the wall
- Tray compatibility: Tray or straight to floor using Roman Shield Wetroom System

Pivot Door

The Embrace Pivot Door is a stunning addition to any bathroom, and takes up less external space when opened. It is an ideal space saving solution as it allows for the close positioning of other bathroom furniture, due to the positioning of the hinge point, meaning it protrudes less into the bathroom.

6mm

900 x 900 Corner Fitting

- Pivot Door EF913S
- Side Panel EGL913
- Roman Low Level Tray RLT90
- Shower Basket RSB06

Code	Description	Size (mm)	Aperture (mm)	Adjustments (mm)	£ ex vat	£ inc vat
EF7613S	Pivot Door	760	455	715 - 760	£398.40	£478.08
EF13S	Pivot Door	800	495	755 - 800	£398.40	£478.08
EF913S	Pivot Door	900	595	855 - 900	£430.77	£516.92

For the full range of compatible Embrace Frameless Side Panels and In-Line Panels see page 92.

Compatible Trays:	Page
InfinityTrays	119 - 120
Anti-Slip Trays	121
Roman Low Level Trays	125 - 126
Roman Shield System	114 - 116



Bi-Fold Door

The in-fold design of the Embrace Bi-Fold Door creates more useable space and minimal bathroom intrusion. The inward opening nature of the Bi-Fold enclosure is perfect for the smaller bathroom as it avoids fixtures and fittings in the bathroom space.

Features and Benefits:

- 6mm glass
- Height: 1900mm
- Frame: Silver
- Smooth running roller bearings
- Reversible for left or right hand fixing
- Tray compatibility: Tray or straight to floor using Roman Shield Wetroom System



1200 Alcove Fitting

- Bi-Fold Door EV1213S
- Roman Low Level Tray RLT129
- Shower Basket RSB02



900 x 900 Corner Fitting

- Bi-Fold Door EV913S
- Side Panel EGL913
- Roman Low Level Tray RLT90
- Shower Basket RSB05

Code	Description	Size (mm)	Aperture (mm)	Adjustments (mm)	£ ex vat	£ inc vat
EV7613S	Bi-Fold Door	760	470	715 - 760	£439.25	£527.10
EV13S	Bi-Fold Door	800	510	755 - 800	£439.25	£527.10
EV913S	Bi-Fold Door	900	610	855 - 900	£479.32	£575.18
EV1013S	Bi-Fold Door	1000	710	955 - 1000	£519.39	£623.27
EV1213S	Bi-Fold Door	1200	910	1155 - 1200	£535.57	£642.68

For the full range of compatible Embrace Frameless Side Panels and In-Line Panels see page 92.

Compatible Trays:	Page
Infinity Trays	119 - 120
Anti-Slip Trays	121
Roman Low Level Trays	125 - 126
Roman Shield System	114 - 116

Features and Benefits:

- 6mm glass
- Height: 1900mm
- Frame: Silver
- Compatible with Embrace corner posts and extension profiles
- Reversible for left or right hand fixing
- In-Line and Neo-Angle Panels are 8mm thick glass offering extra rigidity

Side Panels, In-Line Panels and Neo-Angle Panels

6mm



- Embrace 760mm Pivot Door EF7613S
- 1200 x 900mm Neo Angle Pack EP1213S



- Embrace 760mm Bi-Fold Door EV813S
- 400mm In-Line Panel EHL413S



- Embrace 760mm Pivot Door EF7613S
- 1200 x 900mm Neo Angle Pack EP1213S

Code	Description	Size (mm)	Glass (mm)	Aperture (mm)	Adjustments (mm)	£ ex vat	£ inc vat
EGL713S	Side	700	6	EF/EL/EV/ET/E3T/E1T	660 - 685	£251.82	£302.18
EGL7613S	Side	760	6	EF/EL/EV/ET/E3T/E1T	720 - 745	£251.82	£302.18
EGL813S	Side	800	6	EF/EL/EV/ET/E3T/E1T	760 - 785	£251.82	£302.18
EGL913S	Side	900	6	EF/EL/EV/ET/E3T/E1T	860 - 885	£273.98	£328.78
EGL1013S	Side	1000	6	EF/EL/EV/ET/E3T/E1T	960 - 985	£296.86	£356.23
EHL213S	In-Line	200	6	EF76/EV76	950 - 1000	£248.35	£298.02
EHL313S	In-Line	300	6	EF76/EV76/EL76	1050 - 1100	£248.35	£298.02
EHL413S	In-Line	400	6	EF/EV/EL	1150 - 1200	£248.35	£298.02
EHL813S	In-Line	800	6	EV9/EL9/EF9	1532 - 1582	£274.64	£329.57
EP913S*	Neo Pack	900 x 900	6	EV76/EF76	17 each side	£382.02	£458.42
EP1213S*	Neo Pack	1200 x 900	6	EV76/EF76	17 each side	£409.04	£490.85
VZEXS	Extension profile			EF/EV/EL/ET/E1T	35 (extra)	£49.88	£59.86

For Neo-Angle tray information see page 122.

* For use with Bi-Fold and Pivot Doors. N.B. Additional bracing maybe required for certain installations.

9mm

Trapezium

This ultimate space saving enclosure has been designed to overcome the most common UK bathroom problem; restrictions presented by a window, door position, or other bathroom furniture. The angled design and unique footprint uses the space economically to work around existing fittings, whilst only taking up space on a single wall. It also incorporates an inward opening Bi-Fold Door.

Features and Benefits:

- 6mm glass door 8mm glass Side Panels
- Height: 1900mm
- Frame: Silver
- Vertical adjustment: 25mm each profile
- Adjustment: 17mm in each profile:
- Tray compatibility: LAT1 left or right handing
- Enclosure reversible for left or right hand fixing
- Dimensions: 1180 x 780mm:
760mm Door
900mm Angled Panel
760mm Side Panel



Trapezium

- Embrace Trapezium EAF13S01
- Shower Tray LAT1L
- Shower Basket RSB06

Roman Stone Tray

For best performance we recommend the use of Roman Trapezium Tray. Must indicate left or right handing of the tray e.g. LAT1L

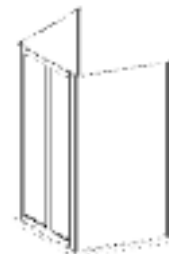

EAF13S01
L/H Tray

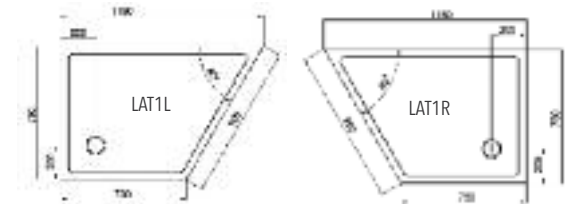

Code	Description	£ ex vat	£ inc vat
EAF13S01	Trapezium Enclosure	£1108.21	£1329.85

Code	Description	£ ex vat	£ inc vat
LAT1	Roman Stone Tray	£275.00	£330.00



Collage

Affordable showering with uncompromised quality

Framed Collection

Our Collage collection delivers a sense of subtle luxury to your bathroom, encompassing a shower concept to meet all your requirements - without compromising on quality. Innovative and affordable product designs meet contemporary and minimal styling, but with the lifetime guarantee you would expect from Roman. This incredibly versatile collection comprises functional and practical wetroom panels, inward opening bi-fold and sliding doors, outward opening hinged and pivot doors, and over the bath showering solutions.

Specifications:

- All enclosures in the range are fully approved for use with power showers - for bath screens please see each product specification.
- Models that feature handle entry, present an elegant ergonomic bolt through handle which can be operated from inside and outside the unit.
- All Collage enclosures and bath screens are supplied pre-coated with Roman Ultra Care - to aid glass protection from day one.

Collage

4mm



1200 Alcove Fitting

- Bi-Fold Door CV12135
- Roman Low Level Tray RLT127
- Shower Basket RSB06

Features and Benefits:

- 4mm glass
- Height: 1830mm
- Frame: Silver or white
- Reversible for left or right hand fixing
- Fully framed door with magnetic closing mechanism and cushioned seals
- Full length integral handle on inside and outside of door
- Precision roller bearing mechanism for smooth sliding action
- Tray compatibility: Tray or straight to floor using Roman Shield Wetroom System



Code	Size (mm)	Aperture (mm)	Frame	Adjustments (mm)	£ ex vat	£ inc vat
CV713S	700	470	Silver	650 - 705	£350.17	£420.20
CV713W	700	470	White	650 - 705	£350.17	£420.20
CVP13S	760	500	Silver	680 - 735	£350.17	£420.20
CVP13W	760	500	White	680 - 735	£350.17	£420.20
CV13S	760/800	560	Silver	740 - 795	£350.17	£420.20
CV13W	760/800	560	White	740 - 795	£350.17	£420.20
CV913S	900	650	Silver	830 - 885	£385.19	£462.23
CV913W	900	650	White	830 - 885	£385.19	£462.23
CV1013S	1000	760	Silver	940 - 995	£420.20	£504.24
CV1013W	1000	760	White	940 - 995	£420.20	£504.24
CV1213S	1200	965	Silver	1145 - 1200	£455.22	£546.26
CV1213W	1200	965	White	1145 - 1200	£455.22	£546.26

Compatible Trays:	Page
Infinity Trays	119 - 120
Anti-Slip Trays	121
Roman Low Level Trays	125 - 126
Roman Shield System	114 - 116

For the full range of compatible Collage Side Panels, In-Line Panels and Extension profiles see page 100.

Bi-Fold Door

An extremely flexible and practical product for where inward opening entry is ideal. It is available in an array of width fittings and features precision roller bearings for a smooth sliding action.

4mm



1200 x 700 Corner Fitting

- Bi-Fold Door CV1213S
- Side Panel CGM7613S
- Roman Low Level Tray RLT127
- Shower Basket RSB06

4mm

Sliding Door & Corner Entry

The Collage Sliding Door and Corner Entry are ideal for any style bathroom. The sliding doors are perfect for confined or awkward spaces as they do not protrude out into the bathroom. Cushioned magnetic seals eliminate noise when closing the door(s). Available with polished silver or white frame.

Features and Benefits:

- 4mm glass
- Height: 1830mm
- Sliding Door frame: Silver or white
- Corner Entry frame: Silver
- Reversible for left or right hand fixing
- Fully framed door(s), with cushioned magnetic seal
- Full length handle on inside and outside of enclosures
- Tray compatibility: Tray or straight to floor using Roman Shield Wetroom System



1200 x 700 Corner Fitting

- Sliding Door CT1213S
- Side Panel CGM13S
- Roman Low Level Tray RLT127
- Shower Basket RSB01



760/800 Corner Entry

- Corner Entry CR13S
- Roman Low Level Tray RLT80
- Shower Basket RSB02

For the full range of compatible Collage Side Panels, In-Line Panels and Extension profiles see page 100.

Code	Size (mm)	Aperture (mm)	Frame	Adjustments (mm)	£ ex vat	£ inc vat
Sliding Door - One sliding door with roller bearing action and cushioned magnetic closing						
CT1013S	1000	360	Silver	965 - 1020	£383.33	£460.00
CT1013W	1000	360	White	965 - 1020	£383.33	£460.00
CT1213S	1200	450	Silver	1140 - 1195	£416.67	£500.00
CT1213W	1200	450	White	1140 - 1195	£416.67	£500.00
Corner Entry - Two sliding doors with roller bearing action and magnetic closing						
CR13S	760/800	400	Silver	755 - 780	£430.98	£517.18
CR913S	900	510	Silver	855 - 880	£454.72	£545.66
CR9713S	900/760	480	Silver	755 - 780 & 855 - 880	£442.85	£531.42

Compatible Trays:	Page
Infinity Trays	119 - 120
Anti-Slip Trays	121
Roman Low Level Trays	125 - 126
Roman Shield System	114 - 116

Features and Benefits:

- 8mm glass
- Height: 1830mm
- Frame: Silver or white
- Reversible for left or right hand fixing
- Unframed door with twin ball catch closing mechanism
- Top rail can be removed in alcove installation
- Ergonomic handle on inside and outside of unit
- Full length PVC seals and deflector guide
- Outward opening doors must be hinged from the wall only
- Tray compatibility: Tray or straight to floor using Roman Shield Wetroom System



*Reduced height Collage 760mm Hinged Door CLP1713S shown with top rail removed.

Code	Size (mm)	Aperture (mm)	Frame	Adjustments (mm)	£ ex vat	£ inc vat
CLP13S	760	535	Silver	690 - 745	£391.92	£470.30
CLP13W	760	535	White	690 - 745	£391.92	£470.30
CL13S	760/800	575	Silver	730 - 785	£391.92	£470.30
CL13W	760/800	575	White	730 - 785	£391.92	£470.30
CL913S	900	675	Silver	830 - 885	£426.94	£512.33
CL913W	900	675	White	830 - 885	£426.94	£512.33
CL1013S	1000	775	Silver	930 - 985	£441.08	£529.30
CL1013W	1000	775	White	930 - 985	£441.08	£529.30

*Our most requested Bespoke enclosure:

CLP1713S	Bespoke reduced height 760 x 1700mm	Silver			£371.49	£445.79
----------	-------------------------------------	--------	--	--	---------	---------

Please contact customer service on **01325 328033** or visit:

www.roman-showers.com/roman-customers/available-downloads/ for more information.

For the full range of compatible Collage Side Panels, In-Line Panels and Extension profiles see page 100.

Hinged Door

Strong and sturdy, yet with sophisticated styling, the Collage Hinged Door demands attention. It features 8mm glass and a deflector to guide water back into the tray and eliminate the potential for leakage under the door. The Frameless Side Panel matches the quality and feel of the Hinged Door.



760/800 Corner Fitting

- Hinged Door CL13S
- Frameless Side Panel CGM13S
- Roman Low Level Tray RLT80
- Shower Basket RSB03

Compatible Trays:	Page
Infinity Trays	119 - 120
Anti-Slip Trays	121
Roman Low Level Trays	125 - 126
Roman Shield System	114 - 116

4mm

Pivot Door

The simplicity of the Collage Pivot Door creates a stunning and contemporary showering solution. The Collage Pivot Door takes up minimal external space when opened and can be installed in an alcove or with a side panel.



900 Alcove Fitting

- Pivot Door CF913S
- Roman Low Level Tray RLT90
- Shower Basket RSB05

Features and Benefits:

- 4mm glass
- Height: 1830mm
- Frame: Silver or white
- Reversible for left or right hand fixing
- Fully framed door with ball catch closing mechanism
- Full length handle on inside and outside of door
- Full length cushion seals and deflector guide
- Outward opening doors must be hinged from the wall only
- Tray compatibility: Tray or straight to floor using Roman Shield Wetroom System

Code	Size (mm)	Aperture (mm)	Frame	Adjustments (mm)	£ ex vat	£ inc vat
CF713S	700	405	Silver	650 - 705	£297.64	£357.17
CF713W	700	405	White	650 - 705	£297.64	£357.17
CFP13S	760	445	Silver	690 - 745	£297.64	£357.17
CFP13W	760	445	White	690 - 745	£297.64	£357.17
CF13S	760/800	485	Silver	730 - 785	£297.64	£357.17
CF13W	760/800	485	White	730 - 785	£297.64	£357.17
CF913S	900	620	Silver	865 - 920	£325.93	£391.12
CF913W	900	620	White	865 - 920	£325.93	£391.12

For the full range of compatible Collage Side Panels, In-Line Panels and Extension profiles see page 100.

Compatible Trays:	Page
Infinity Trays	119 - 120
Anti-Slip Trays	121
Roman Low Level Trays	125 - 126
Roman Shield System	114 - 116

Features and Benefits:

- 6mm glass
- Height: 1830mm
- Frame: Silver or white
- Reversible for left or right hand fixing
- All Collage Doors are suitable for all Collage Side Panels and In-Line Panels
- Outward opening doors must be hinged from the wall

Code	Panel Type	Size (mm)	Frame	To Suit Tray Size	To Suit Door	Adjustments (mm)	£ ex vat	£ inc vat
Side Panels								
CGM713S	Side Panel	700	Silver	700mm side	CF/CL/CV/CT	630 - 685	£215.83	£259.00
CGM713W	Side Panel	700	White	700mm side	CF/CL/CV/CT	630 - 685	£215.83	£259.00
CGM7613S	Side Panel	760	Silver	760mm side	CF/CL/CV/CT	690 - 745	£215.83	£259.00
CGM7613W	Side Panel	760	White	760mm side	CF/CL/CV/CT	690 - 745	£215.83	£259.00
CGM13S	Side Panel	800	Silver	800mm side	CF/CL/CV/CT	730 - 785	£215.83	£259.00
CGM13W	Side Panel	800	White	800mm side	CF/CL/CV/CT	730 - 785	£215.83	£259.00
CGM913S	Side Panel	900	Silver	900mm side	CF/CL/CV/CT	830 - 885	£236.94	£284.33
CGM913W	Side Panel	900	White	900mm side	CF/CL/CV/CT	830 - 885	£236.94	£284.33
CGM1013S	Side Panel	1000	Silver	1000mm side	CF/CL/CV/CT	930 - 985	£258.72	£310.46
CGM1013W	Side Panel	1000	White	1000mm side	CF/CL/CV/CT	930 - 985	£258.72	£310.46
CGM1213S	Side Panel	1200	Silver	1200mm side	CF/CL/CV/CT	1130 - 1185	£286.64	£343.97
CGM1213W	Side Panel	1200	White	1200mm side	CF/CL/CV/CT	1130 - 1185	£286.64	£343.97
In-Line Panels								
CHM213S	In-Line Panel	200	Silver	1000mm side	CF7/CV7	940 - 1040	£215.83	£259.00
CHM213W	In-Line Panel	200	White	1000mm side	CF7/CV7	940 - 1040	£215.83	£259.00
CHM313S	In-Line Panel	300	Silver	1100mm side	CFP/CVP/CLP	1030 - 1130	£215.83	£259.00
CHM313W	In-Line Panel	300	White	1100mm side	CFP/CVP/CLP	1030 - 1130	£215.83	£259.00
CHM413S	In-Line Panel	400	Silver	1200mm side	CF/CV/CL	1145 - 1245	£215.83	£259.00
CHM413W	In-Line Panel	400	White	1200mm side	CF/CV/CL	1145 - 1245	£215.83	£259.00
CHM813S	In-Line Panel	800	Silver	1600mm side	CV9/CL9	1530 - 1630	£236.94	£284.33
CHM813W	In-Line Panel	800	White	1600mm side	CV9/CL9	1530 - 1630	£236.94	£284.33
Neo-Angle Panel Packs								
CPM913S	Neo Pack	900	Silver	900mm Neo Angle	CFP/CVP	35 each side	£322.04	£386.45
CPM913W	Neo Pack	900	White	900mm Neo Angle	CFP/CVP	35 each side	£322.04	£386.45
Extension Profiles								
CZXS	Extension Profile		Silver	-		35mm extra	£43.10	£51.72
CZEXW	Extension Profile		White	-		35mm extra	£43.10	£51.72

Frameless Side Panels, In-Line Panels and Neo-Angle Panel packs

6mm



- Collage 760/800mm Hinged Door CL13S
- 400mm Frameless In-Line Panel CHM413S
- 760mm Frameless Side Panel CGM13S
- Shower Basket RSB03



- Collage 760/800mm Bi-Fold Door CV13S
- CM913S Neo Pack
- Shower Basket RSB03
- Neo-Angle Tray





Wetroom Panels

Complete inclusivity and minimalism in the showering area is achieved with our exceptional collection of wetroom systems.

Wetroom Ranges:

Select

Embrace

Collage

Roman Shield Wetroom System

Installing a Wetroom

Wetroom shower panels are a more open alternative to a shower enclosure, which usually consist of just one glass panel. This can either be positioned in a corner or on a straight wall. Wetroom panels can be installed onto a shower tray, or installed straight down to floor. When wetroom panels are installed on to a low level shower tray it simulates a wetroom look, it removes the traditional step up into the showering area and offers level access entry. When installing straight to floor, your floor and walls must be waterproof (tanked). You can use a system such as our Roman Shield to tank your space, which includes everything you need to tank a room, including complete wetroom kits to make the process easy.

The Roman Wetroom Collection offers a variety of heights, shapes, glass thicknesses and price points – with a multitude of design options to choose from.

10 & 8 mm Wetrooms

Select Wetroom Solutions

The perfect way to create a wetroom -
tailored to your own style

Roman's Select Collection features our Wetroom Panel options, which can be fitted to our low level shower trays or straight to floor to create a true wetroom. We present a number of panel sizes and options, to help you create your perfect bathroom sanctuary. Included are the various configurations that are available to suit you and your bathroom. All Panels are 2000mm high and available in either 8mm glass thickness or 10mm glass thickness.

Selecting your configuration

Select the size of panel you require in either 8 or 10mm glass thickness; select your configuration; select between a fixed or pivoting deflector panel; and select your desired bracing bars.

please see pages 104 - 106 for more information

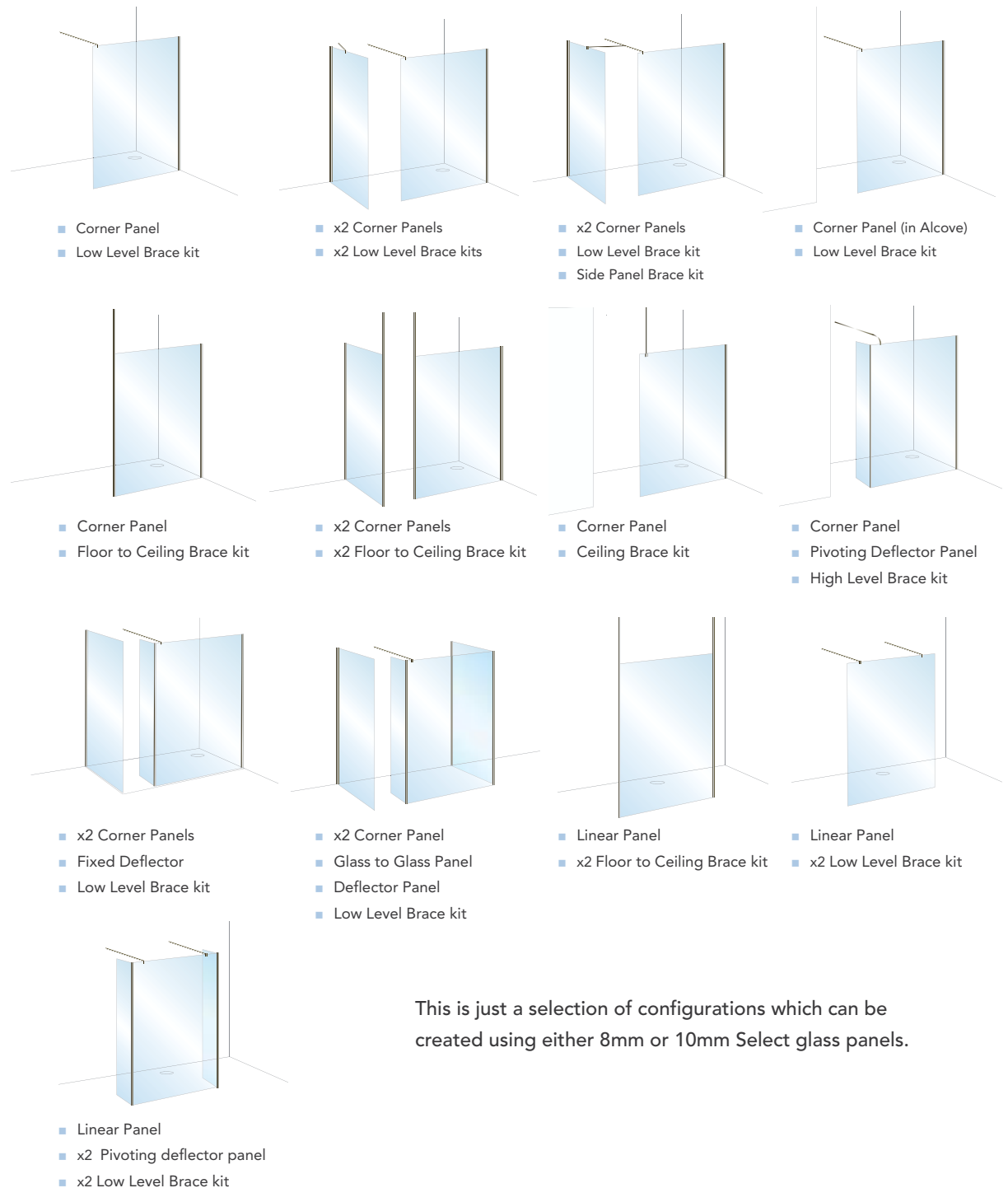

This is just a selection of configurations which can be created using either 8mm or 10mm Select glass panels.

8mm Glass

10mm Glass

Description	Actual Width	Order Code	RRP ex Vat	RRP inc Vat	Actual Width	Order Code	RRP ex Vat	RRP inc Vat
-------------	--------------	------------	------------	-------------	--------------	------------	------------	-------------

Corner Panel (includes wall fixing kit allowing +/- 7.5mm of vertical adjustment). For brace bar options see page 105.

600 Corner Panel	565mm	V8SP613S	£180.00	£216.00	557mm	V10SP613S	£205.00	£246.00
700 Corner Panel	665mm	V8SP713S	£187.50	£225.00	657mm	V10SP713S	£215.00	£258.00
760 Corner Panel	725mm	V8SP7613S	£192.50	£231.00	717mm	V10SP7613S	£222.50	£267.00
800 Corner Panel	765mm	V8SP813S	£195.00	£234.00	757mm	V10SP813S	£227.50	£273.00
900 Corner Panel	865mm	V8SP913S	£202.50	£243.00	857mm	V10SP913S	£237.50	£285.00
1000 Corner Panel	965mm	V8SP1013S	£212.50	£255.00	957mm	V10SP1013S	£250.00	£300.00
1100 Corner Panel	1065mm	V8SP1113S	£226.50	£271.80	1057mm	V10SP1113S	£266.50	£319.80
1200 Corner Panel	1165mm	V8SP1213S	£240.50	£288.60	1157mm	V10SP1213S	£283.00	£339.60
1400 Corner Panel	1365mm	V8SP1413S	£254.50	£305.40	1357mm	V10SP1413S	£299.50	£359.40

Deflector Panel (includes fixed or pivoting corner fixing kit) see page 106 for more details. For brace bar options see page 105.

200 Fixed Deflector Panel	226mm	V8SPL213S	£122.28	£146.74	226mm	V10SPL213S	£145.00	£174.00
200 Pivoting Deflector Panel	243mm	V8SPM213S	£157.50	£189.00	243mm	V10SPM213S	£187.43	£224.92
300 Pivoting Deflector Panel	343mm	V8SPM313S	£161.88	£194.26	343mm	V10SPM313S	£192.64	£231.17
400 Pivoting Deflector Panel	443mm	V8SPM413S	£166.25	£199.50	443mm	V10SPM413S	£197.84	£237.41

Linear Panel (includes freestanding floor fixing kit). For brace bar options see page 105.

1000 Linear Panel	955mm	V8LP1013S	£212.50	£255.00	940mm	V10LP1013S	£250.00	£300.00
1100 Linear Panel	1067mm	V8LP1113S	£226.50	£271.80	1040mm	V10LP1113S	£266.50	£319.80
1200 Linear Panel	1167mm	V8LP1213S	£240.50	£288.60	1140mm	V10LP1213S	£283.00	£339.60
1400 Linear Panel	1355mm	V8LP1413S	£254.50	£305.40	1340mm	V10LP1413S	£299.50	£359.40

Glass to Glass Panel (includes fixing kit). For brace bar options see page 105.

600 Front Panel	567mm	V8FP613S	£180.00	£216.00	556mm	V10FP613S	£205.00	£246.00
700 Front Panel	667mm	V8FP713S	£187.50	£225.00	656mm	V10FP713S	£215.00	£258.00
760 Front Panel	727mm	V8FP7613S	£192.50	£231.00	716mm	V10FP7613S	£222.50	£267.00
800 Front Panel	767mm	V8FP813S	£195.00	£234.00	756mm	V10FP813S	£227.50	£273.00
900 Front Panel	867mm	V8FP913S	£202.50	£243.00	856mm	V10FP913S	£237.50	£285.00
1000 Front Panel	967mm	V8FP1013S	£212.50	£255.00	956mm	V10FP1013S	£250.00	£300.00
1100 Front Panel	1067mm	V8FP1113S	£226.50	£271.80	1056mm	V10FP1113S	£266.50	£319.80
1200 Front Panel	1167mm	V8FP1213S	£240.50	£288.60	1156mm	V10FP1213S	£283.00	£339.60

All panels are 2000mm in height

No brace bars included - please see page 105 to select your style of Bracing required. For Panel and Tray Packs see page 106

- Due to the nature of the product water integrity cannot be guaranteed - please consult your installer

Compatible Trays:	Page
Infinity Trays	119 - 120
Anti-Slip Trays	121
Roman Low Level Trays	125 - 126
Roman Shield System	114 - 116



Corner Panel
Fixed Deflector Panel
Low Level Brace

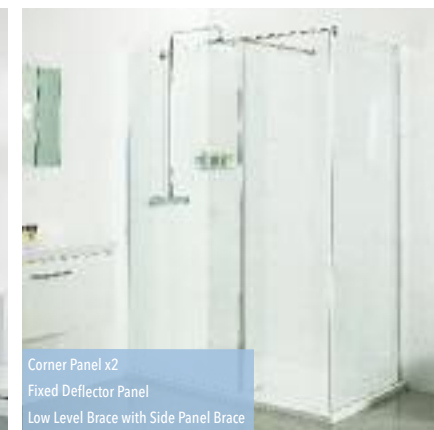

Corner Panel x2
Fixed Deflector Panel
Low Level Brace with Side Panel Brace

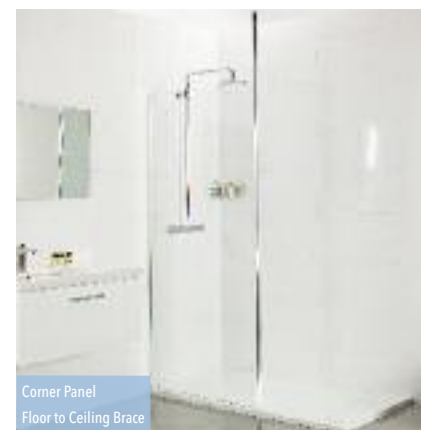

Corner Panel
Floor to Ceiling Brace

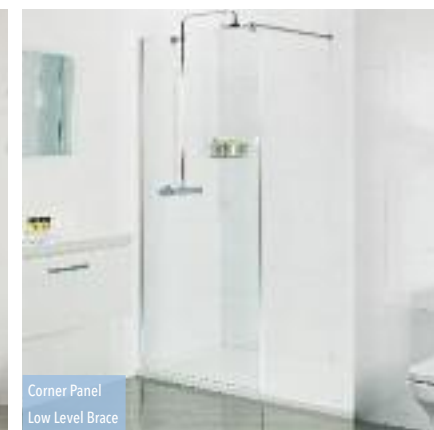

Corner Panel
Low Level Brace

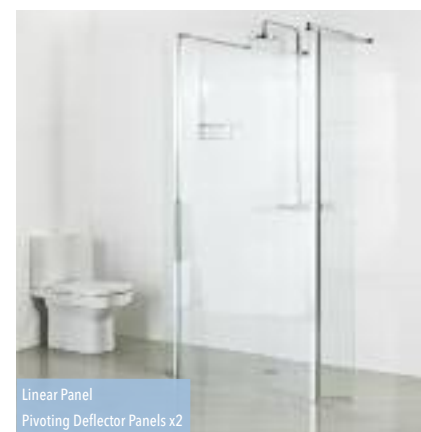

Linear Panel
Pivoting Deflector Panels x2

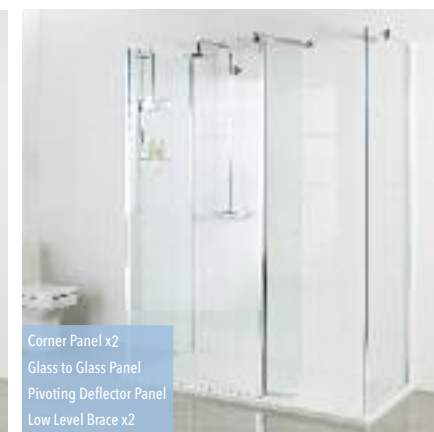

Corner Panel x2
Glass to Glass Panel
Pivoting Deflector Panel
Low Level Brace x2

Brace Bars

Roman provides a number of different styles of bracing bars, which can be used with 8mm and 10mm glass thicknesses. We offer all configurations that may be required and they can be cut and trimmed to the size required during installation to allow maximum flexibility and use of space. Bracing kits are used to provide added support for the glass and ensure that it is securely fitted in place.

Our bracing bars range from Ceiling Bracing Kits to 45 Degree Angle Bracing Kits and from Curved Bracing Kits to Floor to Ceiling Bracing Kits. We have something to suit the enclosure style, your bathroom area and your preference, to present the highest level of stability.

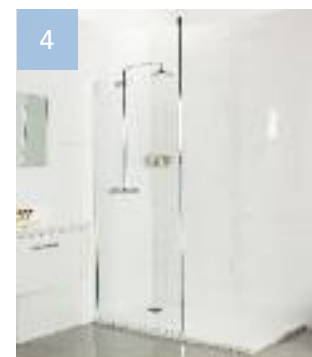

Key:

1. Low Level Brace Kit *
2. Side Panel Brace Kit (for use with LBBK4590*)
3. Ceiling Brace Kit
4. Floor to Ceiling Brace Kit
5. High Level Brace Kit

Description	Code	Size (mm) Max	Adjustments (mm) Min	For use with Glass Thickness	£ ex vat	£ inc vat
Low Level Brace Kit*	LBBK4590	1030	Cut to suit	6mm / 8mm / 10mm	£82.87	£99.44
Side Panel Brace Kit (use with LBBK4590)	LBBKT90		Cut to suit	6mm / 8mm / 10mm	£82.87	£99.44
Ceiling Brace Kit	LBBKC50	560	Cut to suit	6mm / 8mm / 10mm	£79.91	£95.89
Floor to Ceiling Brace Kit	RF2C8KIT	2700 high	Cut to suit	8mm	£89.26	£107.11
High Level Brace Kit	FBBK10	1135	Cut to suit	6mm / 8mm / 10mm	£89.26	£107.11

*For use straight back to wall or can be cut to 45° if required for corner fixing as illustrated in 1 and 1(b).

N.B. Adjustments are measured from the wall to the inside of the glass.

Deflector Panels

Pivoting Panel

Features and Benefits:

- Retro Fitable
- Improve water integrity
- Rotates through 180°
- Smooth pivot motion
- Stows when not in use to improve access



Fixed Panel

Features and Benefits:

- Retro Fitable
- Panel Foot adjusts from 4mm to 29mm to accommodate high and low level trays
- Panel foot is chromed brass with soft rubber base
- Panel foot is cut down on site to suit the shower tray

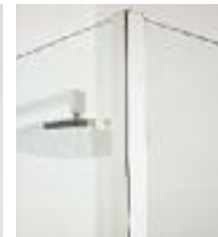

Adjustable Foot

Panels & Tray Packs

Alcove Package includes:

1 Panel, Wall Fixing Kit, 1 Brace Bar (LBBK4590), Tray and 90mm Waste

Corner Package includes:

2 Panels, Wall Fixing Kits, 2 Brace Bars (LBBK4590 & LBBKT90), Tray and 90mm Waste

Tray included with the pack is a Roman Acrylic Capped Stone low level 40mm in height.

For full tray details see pages 125.



Alcove Pack



Corner Pack

Shower Panels & Tray		8mm Glass Thickness			10mm Glass Thickness		
Description	Tray Size (mm)	Order Code	RRP ex Vat	RRP inc Vat	Order Code	RRP ex Vat	RRP inc Vat
Panel Pack Alcove	1400 x 900	V8W149AS	£600.37	£720.44	V10W149AS	£635.37	£762.44
Panel Pack Alcove	1500 x 800	V8W158AS	£650.37	£780.44	V10W158AS	£687.87	£825.44
Panel Pack Alcove	1600 x 800	V8W168AS	£699.37	£839.24	V10W168AS	£739.37	£887.24
Panel Pack Alcove	1700 x 800	V8W178AS	£733.37	£880.04	V10W178AS	£775.87	£931.04
Panel Pack Corner	1400 x 900	V8W149CS	£885.74	£1062.89	V10W149CS	£955.74	£1146.89
Panel Pack Corner	1500 x 800	V8W158CS	£928.24	£1113.89	V10W158CS	£998.24	£1197.89
Panel Pack Corner	1600 x 800	V8W168CS	£977.24	£1172.69	V10W168CS	£1049.74	£1259.69
Panel Pack Corner	1700 x 800	V8W178CS	£1011.24	£1213.49	V10W178CS	£1086.24	£1303.49

Select



- Embrace 900mm Corner Panel
- Roman Shield Wetroom System
- Shower Basket RSB01



- Embrace 1000mm Linear Panel ELLP1013S
- Roman Shield Wetroom System
- Shower Basket RSB04



- Embrace 200mm Pivoting L Panel ESPM213S fitted to Embrace 1100mm Corner Wetroom Panel ESP1113S and Wetroom Panel ESP813S
- Gloss Infinity Tray IAG168
- Shower Basket RSB01

Features and Benefits:

- 8mm glass
- Height: 2000mm
- Frame: Silver
- LBBK4590 brace bar supplied with Corner Panels 1000mm and above.
- Two LBBK4590 brace bars supplied with Linear Panels
- Chromed top caps
- Maximum distance from wall when using bracing 1060mm
- ESP - reversible for left or right hand fixing
- Due to the nature of the product water integrity cannot be guaranteed - please consult your installer
- Tray compatibility: Tray or straight to floor using Roman Shield Wetroom System

Code	Description	Size (mm)	Adjustments (mm)	£ ex vat	£ inc vat
ESP613S	Corner Panel	600	578 - 603	£265.47	£318.56
ESP713S	Corner Panel	700	678 - 703	£265.47	£318.56
ESP813S	Corner Panel	800	778 - 803	£265.47	£318.56
ESP913S	Corner Panel	900	878 - 903	£288.64	£346.37
ESP1013S	Corner Panel	1000	978 - 1003	£391.47	£469.76
ESP1113S	Corner Panel	1100	1078 - 1103	£407.26	£488.71
ESP1213S	Corner Panel	1200	1178 - 1203	£423.06	£507.67
ESP1413S	Corner Panel	1400	1378 - 1403	£459.28	£551.14
ELLP913S	Linear Panel	827	35 in wall cup	£411.51	£493.81
ELLP1013S	Linear Panel	927	35 in wall cup	£443.10	£531.72
ELLP1213S	Linear Panel	1127	35 in wall cup	£474.69	£569.63
ELLP1413S	Linear Panel	1327	35 in wall cup	£506.29	£607.55

For alternative styles of bracing bars please see page 105.

Pivoting 'L' Panel

Features and Benefits:

- 8mm glass
- Height: 2000mm
- Retro-fit panel suitable for all ESP and ELLP panels
- Rotates through 180°
- Smooth pivoting motion
- Chromed decorative top caps

Code	Size (mm)	Adjustment (mm)	£ ex vat	£ inc vat
ESPM213S	200	n/a	£157.50	£189.00
ESPM313S	300	n/a	£161.88	£194.26
ESPM413S	400	n/a	£166.25	£199.50

Where fitting with return panel is required please use one of the following

ESP613S	600	578 - 603	£265.47	£318.56
ESP813S	800	778 - 803	£265.47	£318.56
ESP913S	900	878 - 903	£288.64	£346.37

For alternative styles of bracing bars please see page 105.

Compatible Trays:

Infinity Trays	Page 119 - 120
Anti-Slip Trays	121
Roman Low Level Trays	125 - 126
Roman Shield System	114 - 116

Embrace Wetroom Panels

The Embrace Corner and Linear Panels offer style and sophistication with a seamless glass panel and sleek chrome profile. Effortless entry for all is presented with a stylish finish.

Pivoting 'L' Panel

The Retro Fit Pivoting Panel provides additional water integrity for your wetroom. The Panel rotates through 180 degrees allowing you to fold it inwards for wider entry access and it can be positioned in-line to add more length to the wetroom panel. 200mm and 400mm sizes are available.



Pivoting 'L' Panel



LBBK4590 brace bar



LBBK4590 brace bar cut to 45°



- Embrace 700mm Curved Wetroom Panel ESPC7
- Roman Low Level Tray RLT128
- Shower Basket RSB03

Features and Benefits:

- 8mm glass
- Height: 2000mm
- Frame: Silver
- Bright silver frame with 25mm of adjustment
- Chromed bracing bar supplied as standard
- Chromed brass adjustable panel foot included
- Chromed top caps
- For use in alcove or corner with additional panel
- Due to the nature of the product water integrity cannot be guaranteed - please consult your installer
- Tray compatibility: Tray or straight to floor using Roman Shield Wetroom System



LBBK4590 brace bar

Code	Description	Size (mm)	Adjustment (mm)	Suit Tray Size (mm)				£ ex vat	£ inc vat	
				1100	1200	1400	1500			1600
ESPC713S	Curved Panel	700	615 - 640	460	560	N/A	N/A	N/A	£393.75	£472.50
ESPC813S	Curved Panel	800	785 - 810	N/A	390	590	N/A	N/A	£415.62	£498.74
ESPC913S	Curved Panel	900	885 - 910	N/A	N/A	490	590	690	£437.50	£525.00

Where fitting with **Corner Panel** is required for corner installation (illustrated right) please use one of the following:

Code	Size (mm)	Adjustment (mm)	£ ex vat	£ inc vat
ESP613S	600	578 - 603	£265.47	£318.56
ESP713S	700	678 - 703	£265.47	£318.56
ESP813S	800	778 - 803	£265.47	£318.56
ESP913S	900	878 - 903	£288.64	£346.37

Compatible Trays:	Page
Infinity Trays	119 - 120
Anti-Slip Trays	121
Roman Low Level Trays	125 - 126
Roman Shield System	114 - 116

Corner Fitting

- 800mm Curved Wetroom Panel ESPC813S
- Corner Wetroom Panel ESP713S
- Roman Low Level Tray RLT128
- Shower Basket RSB03

Embrace

Curved Wetroom Panel

The Embrace Curved Wetroom Panel exudes style and luxury standing at 2000mm high with 8mm thick glass and provides effortless level access entry for all users. It incorporates contemporary chromed brass wall bracing to ensure full support and maintain the position of the wetroom panel.





Embrace Hinged Walk-In Panel

This Walk-in enclosure creates a striking contemporary design solution with complete freedom of space. The frameless deflector style door shields the showering area whilst allowing easy access into the showering area.



900 Alcove Fitting

- Embrace Walk-in Panel with Deflector ESPD9R
- Roman Low Level Tray RLT129
- Shower Basket RSB02

Features and Benefits:

- 8mm glass
- Height: 1900mm
- Frame: Silver
- Vertical adjustment: 25mm
- Outward opening only deflector panel
- Chromed bracing bar (LBBK4590 brace bar supplied - see page 105)
- Due to the nature of the product water integrity cannot be guaranteed - please consult your installer
- Tray compatibility: Tray or straight to floor using Roman Shield Wetroom System

- 900mm Walk-in Panel with Deflector recommended for use with 1200mm long tray or wetroom
- 1100mm Walk-in Panel with Deflector recommended for use with 1400mm or 1600mm long tray or wetroom

Code	Size (mm)	Hinged Panel (mm)	Fixed Panel (mm)	Adjustments (mm)	£ ex vat	£ inc vat
ESPD9	900	350	600	963 - 988	£636.42	£763.70
ESPD11	1100	350	800	1163 - 1188	£672.63	£807.16

Must indicate left or right handing of enclosure e.g. ESPD9L or ESPD9R.

Compatible Trays:	Page
Infinity Trays	119 - 120
Anti-Slip Trays	121
Roman Low Level Trays	125 - 126
Roman Shield System	114 - 116

Features and Benefits:

- 8mm glass
- Height: 1830mm
- Frame: Silver
- Vertical adjustment: 30mm each profile
- Corner Panel reversible for left or right hand fitting
- Tray compatibility: Tray or straight to floor using Roman Shield Wetroom System

Corner Panel and Linear Panels

Code	Description	Size (mm)	Adjustments (mm)	Brace Bars	£ ex vat	£ inc vat
CSP213S	Corner Panel	200	247 - 277	Not included	£218.28	£261.94
CSP613S	Corner Panel	600	577 - 607	Not included	£218.28	£261.94
CSP713S	Corner Panel	700	655 - 685	Not included	£218.28	£261.94
CSP813S	Corner Panel	800	792 - 822	Not included	£218.28	£261.94
CSP913S	Corner Panel	900	892 - 922	Not included	£239.87	£287.84
CSP1013S*	Corner Panel	1000	992 - 1022	Inc. FBBK10	£328.98	£394.78
CSP1213S*	Corner Panel	1200	1192 - 1222	Inc. FBBK10	£358.43	£430.12
CSP1413S*	Corner Panel	1400	1392 - 1422	Inc. FBBK10	£392.19	£470.63
CLLP913S*	Linear Panel	850	N/A	Inc. Two FBBK10	£347.66	£417.19
CLLP1013S*	Linear Panel	950	N/A	Inc. Two FBBK10	£377.11	£452.53

* includes FBBK10 brace bar kit allowing adjustment of up to 1140mm from wall

Corner Panel + 'L' Shaped Panel

Features and Benefits:

- Panel foot adjusts from 8mm to 64mm to accommodate high and low level trays
- Panel foot is chromed brass with soft rubber base
- Panel foot is cut down on site to suit the shower tray
- Return panel width is 218mm
- Return panels available as an 'add on' kit CSPL213S
- All sizes suitable for wetroom floor installation

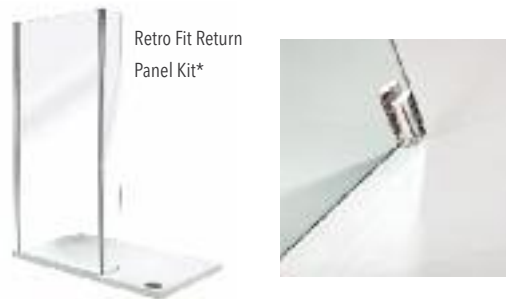

Retro Fit Return Panel Kit*

Code	Description	Size (mm)	Adjustment (mm)	To suit tray size	£ ex vat	£ inc vat
CSPL813S	Corner + Return Panel	800 x 200	799 - 829	900mm and above	£284.90	£341.88
CSPL913S	Corner + Return Panel	900 x 200	899 - 929	1000mm and above	£306.49	£367.79
CSPL1013S	Corner + Return Panel	1000 x 200	999 - 1029	1100mm and above	£410.98	£493.18
CSPL1213S	Corner + Return Panel	1200 x 200	1199 - 1229	1400mm and above	£440.43	£528.52
CSPL213S	218 *Retro Fit Return Panel Kit for use with any Collage Corner or Linear Panel				£105.63	£126.76

* includes FBBK10 brace bar kit allowing adjustment of up to 1140mm from wall

Compatible Trays:	Page
Infinity Trays	119 - 120
Anti-Slip Trays	121
Roman Low Level Trays	125 - 126
Roman Shield System	114 - 116

Collage Reduced Height Corner Panels & Linear Panels

Suitable when ceiling height is limited. There is a 'L' Shaped Panel Kit which can be installed with the wetroom panel. The return panel guides water back into the tray offering the flexibility to create a walk-in enclosure without having to buy a bespoke tray.



1200 Corner Panel

- Corner Panel CSP1213S with Standard Brace Bar FBBK10
- Matt Infinity Tray IA128
- Shower Basket RSB01



900 Linear Panel

- Linear Panel CLLP913S with Brace Bars FBBK10
- Roman Low Level Tray RLT127
- Shower Basket RSB05



ROMAN SHIELD

Pre-formed Shower Floor



Easy to install

European Technical Approval ETA - 0910200



Constructing a Wetroom



Roman presents the all in one wetroom solution with Roman Shield. The Roman Shield Wetroom System includes everything you need to tank a room, including complete wetroom kits to make the process easy. We have a range of kits to choose from including those which contain our Pre-formed Shower Floor. The Solid Surface Shower Floor is designed to be installed onto your joist and then tanked and tiled over – it creates a natural fall towards the waste so you don't need to use a levelling compound, and it also gives the added reassurance of a tray beneath the tanking system, for total water integrity. To view our guide on how to install a wetroom visit: www.roman-showers.com and watch our step-by-step video installation guide.

Wetroom Installation

Features and Benefits:

- Designed with 22mm thick edge work to be compatible with WBP board
- Can be trimmed by 50mm around the edges to miss joists if necessary
- Self-supporting - Installation directly to joists with no additional support
- Nonporous
- Off-centre waste to avoid joists
- 17mm of fall to waste
- Available in 2 sizes: 1000 x 1000mm and 1350 x 850mm
- Suitable for installation to: timber floors, floating floors and concrete floors
- Available with a choice of 2 waste assemblies:
 - a. Tile (RSHSFWT) - supplied with a fast flow waste and stainless steel cover - height adjustable to be compatible with a wide range of tiles
 - b. Vinyl (RSHSFWV) - supplied with a fast flow waste and pressed stainless steel cover which is screw fixed to the waste body - height adjustable to be compatible with 2 - 4mm vinyl
- 10 year Guarantee
- Manufactured from Roman Stone, Solid Surface Technology

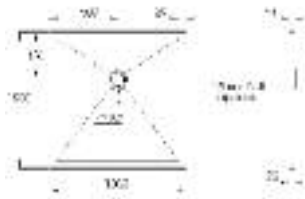

RSHSF10

1000 x 1000mm Pre-Formed Shower Floor

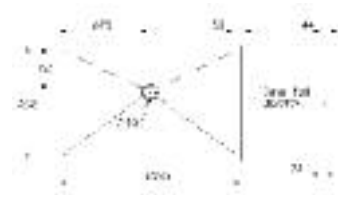

RSHSF138

1350 x 850mm Pre-Formed Shower Floor

Waste Assemblies



RSHSFWT



RSHSFWV

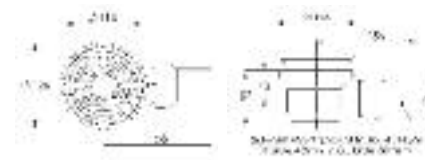
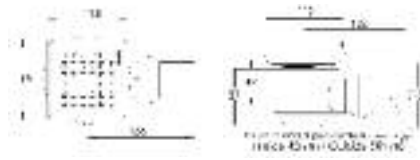

Tray Former and Waste Assemblies

Code	Description	£ ex vat	£ inc vat
RSHSF10	1000 x 1000mm Pre-formed Shower Floor	£384.34	£461.21
RSHSF138	1350 x 850mm Pre-formed Shower Floor	£384.34	£461.21
RSHSFWT	Roman Shield Waste for Tiles	£120.41	£144.49
RSHSFWV	Roman Shield Waste for Vinyl	£91.51	£109.81

N.B. Adjustments are measured from the wall to the inside of the glass.



The Roman Shield Wetroom System - winner of the KBB Readers' Design Award 2009



Winner of the Homebuilding and Renovating Magazine Best Bathroom Product 2011

Choosing the right Wetroom System



To calculate the Roman Shield tanking coverage:

Total area to be tanked = a + b + c. a & b = showering area (floor to ceiling coverage.)

Note: Tanking for the showering area should be applied 100mm past the showering area walls into the splash zone. (E.g. 0.9 x 0.9m showering area = tanking wall to ceiling: 1 x 1m).

c = floor coverage * the entire floor should be tanked with a turn up of 0.1m onto the walls.

Example (showering area 0.9 x 0.9m, room height of 2m and floor size 2m x 2m):

$$a = 1 \times 2 = 2\text{m}^2 \quad b = 1 \times 2 = 2\text{m}^2 \quad c = 2 \times 2 = 4\text{m}^2$$

Total area to be tanked = 8.0m²*

* The entire floor area should be tanked with a turn up of 0.1m onto the walls - you will need to allow extra in your calculation for this.

Roman Shield requirement:

Based on the above calculation one RSH01 – Roman tanking kit will be required covering 10m².

Note: The Roman Shield tape is supplied in a 15m roll and is used to seal all wall to wall and wall to floor joints as well as screw heads. Calculate how much you will need based on your room size and number of joints to cover.

If you wish to use any optional extras such as the internal corners (RSH02) or external corners (RSH04) please calculate based on your site requirements.

The above calculation is for guidance only, coverage of the tanking kit will vary depending on application technique used (roller/brush) and site conditions.

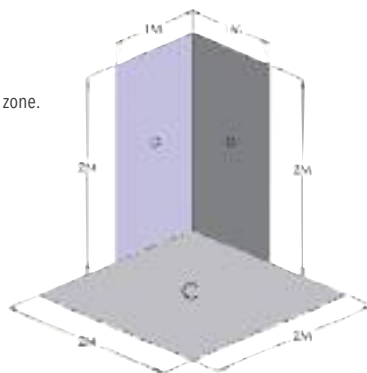

For our **9 Easy Steps Guide** to installing a wetroom please see next page. You can also view a short video podcast guide at www.roman-showers.com or scan the QR code to view video directly on your smart phone



Tanking Kits

Roman Shield Tanking Kit 1: (Covers approx. 10m²)

Product Code	Price ex vat	Price inc vat
RSH01	£262.09	£314.51
Includes:		
2ltr of Primer		
15m of Roman Shield Tape		
1 self-adhesive Shower Outlet Sleeve (drain mat)		
9kg of Roman Tanking Compound		
Installation Instructions & Guarantee Card		

Roman Shield Tanking Kit 2: (Covers approx. 10m²)

Product Code	Price ex vat	Price inc vat
RSH12	£317.88	£381.46
Includes:		
RSH01 Tanking Kit 1 (see above)		
RSH02 Internal Corners x4		
RSH04 External Corners x2		
RSH06 Pipe Sleeves x2		

Complete Wetroom Kits

Roman Shield Wetroom System 1: (Covers approx. 10m²)

Product Code	Price ex vat	Price inc vat
RSHWP01	£722.44	£866.93
Includes:		
RSH01 Tanking Kit 1		
RSHSF10 Pre-Formed Shower Floor		
RSHSFWT Waste for Tiles		

Roman Shield Wetroom System 2: (Covers approx. 10m²)

Product Code	Price ex vat	Price inc vat
RSHWP02	£722.44	£866.93
Includes:		
RSH01 Tanking Kit 1		
RSHSF138 Pre-Formed Shower Floor		
RSHSFWT Waste for Tiles		

Roman Shield Wetroom System 3: (Covers approx. 10m²)

Product Code	Price ex vat	Price inc vat
RSHWP03	£799.51	£959.41
Includes:		
RSH12 Tanking Kit 2		
RSHSF10 Pre-Formed Shower Floor		
RSHSFWT Waste for Tiles		

Roman Shield Wetroom System 4: (Covers approx. 10m²)

Product Code	Price ex vat	Price inc vat
RSHWP04	£799.51	£959.41
Includes:		
RSH12 Tanking Kit 2		
RSHSF138 Pre-Formed Shower Floor		
RSHSFWT Waste for Tiles		

9 Easy Steps

to constructing a wetroom

There are several different ways of constructing a wetroom but there are some basic principles that must be observed - these are:

The floor may be screeded, constructed from heavy duty wooden sheets such as plywood, or created using a pre-formed shower floor. In all cases there must be a gradual slope to fall towards an appropriate shower outlet. The structure must be solid, without flexing and any joints in the construction material must be firm and well fitting. The body of the shower outlet must be recessed or cast into the floor in such a way that the top of the flange is on a level, or fractionally lower than the floor surrounding it. There can be no upwards step into the shower outlet.

Roman Shield can not be used directly over conventional narrow wooden floorboards, such boards must be replaced or covered with a sheet material such as plywood.

To view a short video podcast guide visit www.roman-showers.com or scan the QR code to view video directly on your smart phone

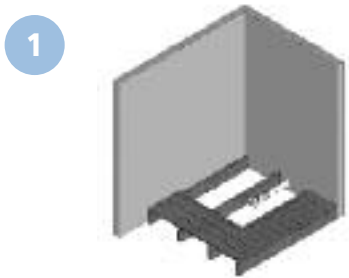

1

Supporting the Pre-formed Shower Floor

The Roman Shield Pre-formed Shower Floor can be installed directly to joists without additional support, or to a concrete floor.



2

Installing the Pre-formed Shower Floor

The Pre-formed Shower Floor can be trimmed if necessary and is screw fixed to the joists. WBP/Plywood can then be used to complete the level shower room.



3

Preparation

Ensure all surfaces in the construction area are dry, solid, supportive and level, as well as free from oil, grease, dust and other separating layers.



4

Applying the Primer

The entire floor area of the room should be primed with a turn up of 100mm onto the walls. The walls should also be primed floor to ceiling in the showering area and in the splash zone of the shower, normally 100mm past the showering area. (E.g. If your showering area is 1000 x 1000mm prime floor to ceiling 1100 x 1100mm). The primer can be applied using a small fur roller, brush or suitable spray gun. The curing time of the primer is a minimum of 2 hours.



5

Apply the Roman Outlet Sleeve

Apply the self adhesive Roman Outlet Sleeve ensuring it is flat with no raised edges, creases or bubbles. The centre of the outlet sleeve is then removed and the waste trap clamping ring is fixed into position.



6

Apply Roman Shield Tape, Pipe Sleeves and Corners

The Roman Shield Tape, Pipe Sleeves and Corners are bedded down using Roman Tanking Compound. All wall to wall and wall to floor junctions as well as butt joints and nail or screw heads must be reinforced with the tanking tape. The compound is applied using a medium size paint brush.



7

Pre-Checks

Ensure the Roman Shield Tape, Pipe Sleeves, Corners and Outlet Sleeve have been fitted to the appropriate areas and wait until the tanking compound is dry. (The curing time for the compound is between 2 - 4 hours).



8

Apply the Roman Tanking Compound

The entire floor area of the room should be tanked with a turn up of 100mm onto the walls. The walls should also be tanked floor to ceiling in the showering area and in the splash zone of the shower, normally 100mm past the showering area. (E.g. If your showering area is 1000 x 1000mm tank floor to ceiling 1100 x 1100mm). The recommended finished thickness of the tanking compound is a minimum of 1mm, this is usually achieved in 2-3 coats. The tanking compound can be applied using a fur roller and/or a large paint brush. The curing time of the tanking compound is between 2 - 4 hours per coat.



9

Installation Complete

You are now ready to start tiling and grouting as normal.

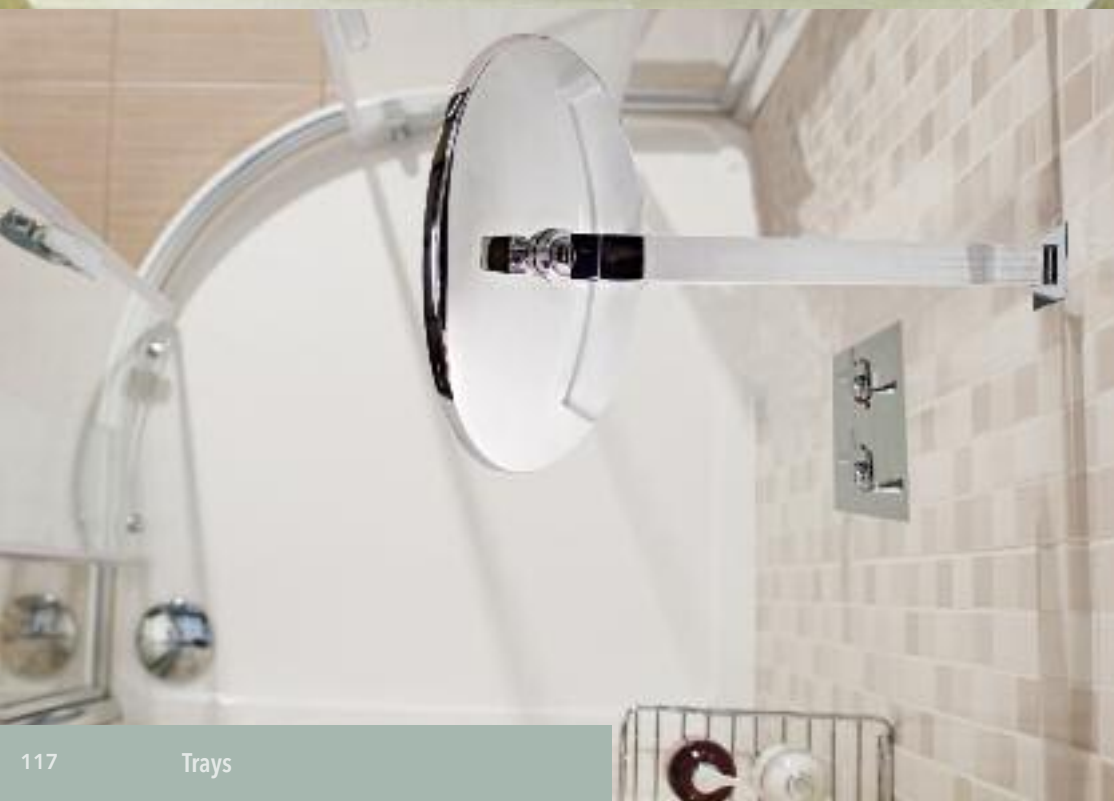
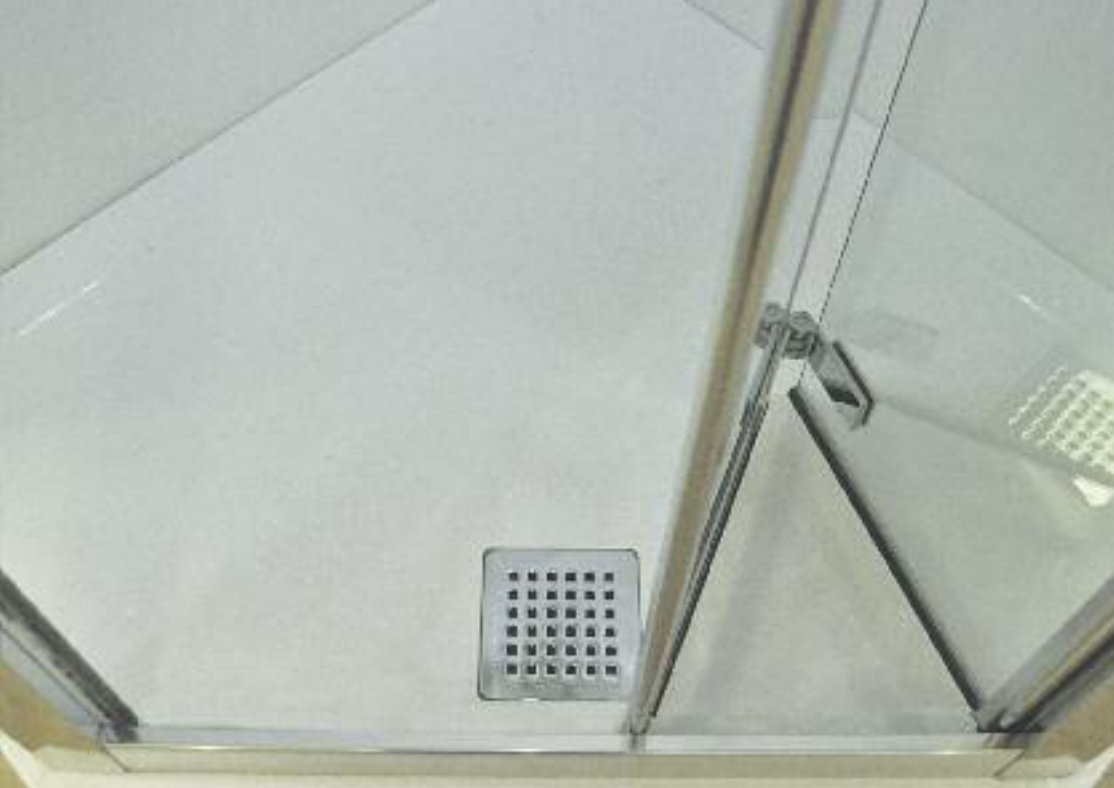



Trays

Our diverse range of trays and wetroom solutions offer the user a choice of installations depending on the desired finish. Our range of level access shower trays is manufactured from solid surface material, and cleverly create a simulated wetroom look. These solid surface trays are available in a range of sizes, and incorporates our Infinity Tray range which has a single angle flow to waste with a stylish load bearing solid surface waste cover. Our Infinity Tray collection also presents true originality with our low level Shimmer Trays, featuring a stunning shimmer finish. These unique designs include radiant black, glittering grey and twinkling white shimmer finishes. The standard acrylic capped stone shower trays are also available in a selection of heights, shapes and sizes.

Types:

- Infinity Trays
- Shimmer Trays
- Neo Angle Trays
- Lumin8 Trays
- Gloss Trays
- Roman Low Level Trays
- Anti Slip Trays

Trays

Infinity Trays



Level access installation

To create the ultimate modern minimalist look Roman introduce the Infinity Tray range which is available in the choice of a matt or gloss finish. Our Infinity Trays offer a breakthrough in technology as they can be installed straight to joists so that once the floor tiles are laid it creates level entry access into the shower area. Manufactured from Roman Stone, the Infinity Trays are strong and durable. They achieve their level access feature due to them being only 40mm nominal height. This product provides the added reassurance of a tray, with the minimalist design and level access of a wetroom. The flawless styling of the Infinity Trays has been designed with a single angle flow to the waste. The waste is suitable for power shower systems and carries away 25 litres of water per minute. This exclusive chic look is completed with a stylish load bearing solid surface waste cover which still allows access to the waste for cleaning.

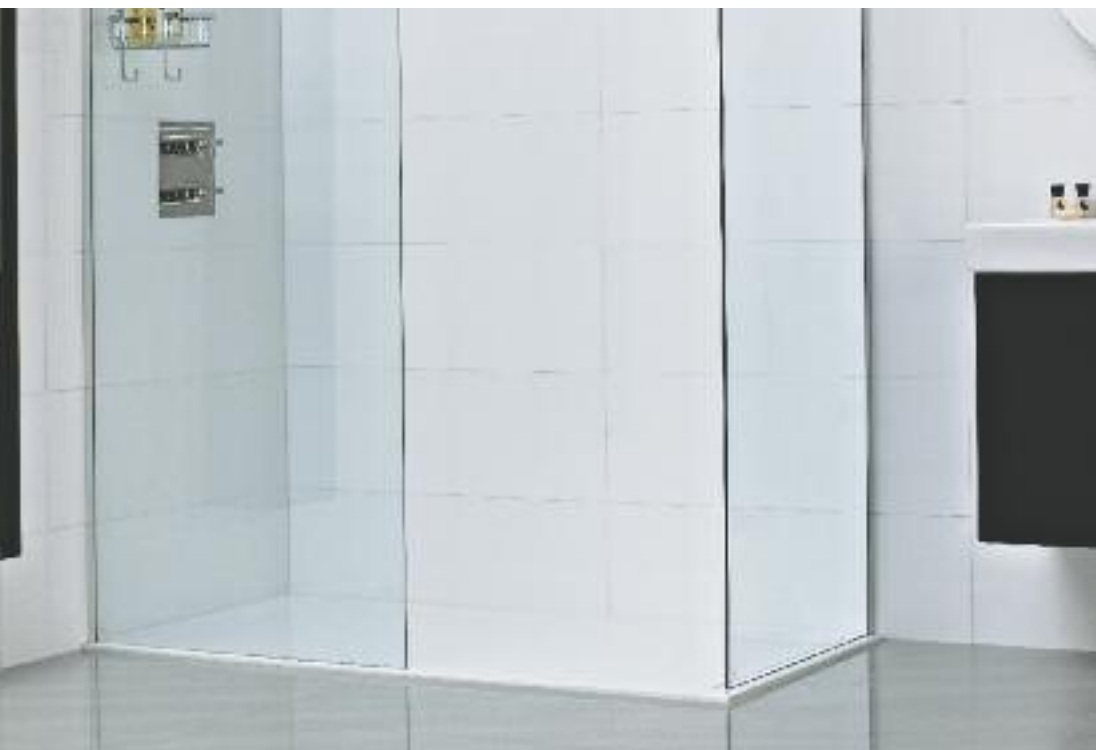

Features and Benefits:

- Ultra low profile
- Gloss or Matt* finish available in white
- Shimmer options in gloss only
- Manufactured using Roman Stone Solid Surface Technology
- One angle of slope to waste to maximise flow rating
- Fast flow waste included, fully concealed with solid surface cover piece
- Due to the nature of the product water integrity cannot be guaranteed when fitting with a wetroom panel. Please consult your installer

* Anti Slip Trays

Matt Trays have been tested to:

BS7679-2:2002+A1:2013 - Slip potential - low DIN 51097:1992 Class C



Shimmer Trays

Exclusive additions to our Infinity Tray collection are original low level shower trays, featuring a stunning shimmer finish. These unique additions include a radiant black, glittering grey and twinkling white shimmer finishes.



Black Shimmer

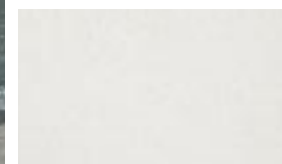

White Shimmer

Grey Shimmer

Infinity Trays

Level access installation

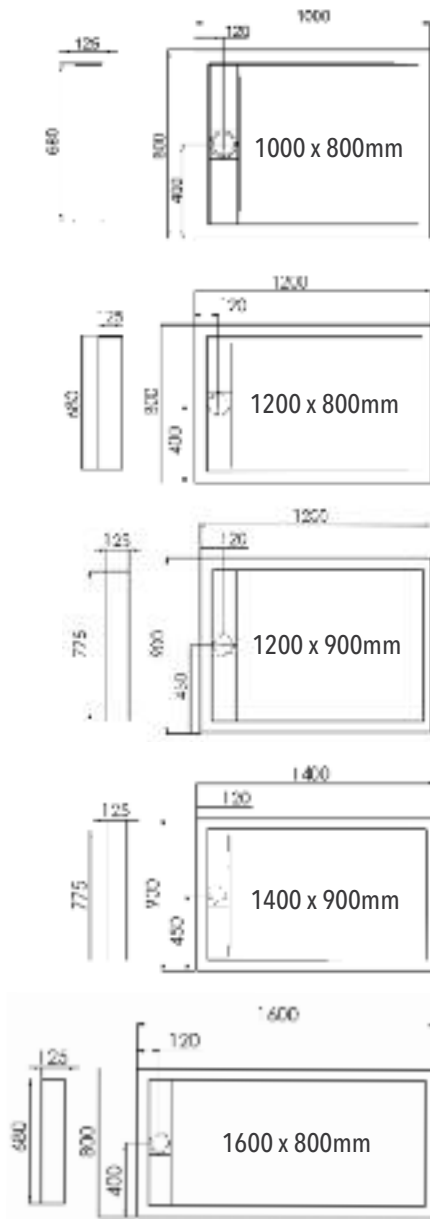

Code	Size (mm)	Colour	Finish	£ ex vat	£ inc vat
RECTANGLE					
IA108*	1000 x 800	White	Matt	£325.50	£390.60
IAG108	1000 x 800	White	Gloss	£348.10	£417.72
IAG108B	1000 x 800	Shimmer Black	Gloss	£424.38	£509.26
IAG108W	1000 x 800	Shimmer White	Gloss	£424.38	£509.26
IAG108G	1000 x 800	Shimmer Grey	Gloss	£424.38	£509.26

IA128*	1200 x 800	White	Matt	£366.19	£439.43
IAG128	1200 x 800	White	Gloss	£388.79	£466.55
IAG128B	1200 x 800	Shimmer Black	Gloss	£463.75	£556.50
IAG128W	1200 x 800	Shimmer White	Gloss	£463.75	£556.50
IAG128G	1200 x 800	Shimmer Grey	Gloss	£463.75	£556.50

IA129*	1200 x 900	White	Matt	£379.75	£455.70
IAG129	1200 x 900	White	Gloss	£402.35	£482.82
IAG129B	1200 x 900	Shimmer Black	Gloss	£476.88	£572.26
IAG129W	1200 x 900	Shimmer White	Gloss	£476.88	£572.26
IAG129G	1200 x 900	Shimmer Grey	Gloss	£476.88	£572.26

IA149*	1400 x 900	White	Matt	£420.44	£504.53
IAG149	1400 x 900	White	Gloss	£443.04	£531.65
IAG149B	1400 x 900	Shimmer Black	Gloss	£516.25	£619.50
IAG149W	1400 x 900	Shimmer White	Gloss	£516.25	£619.50
IAG149G	1400 x 900	Shimmer Grey	Gloss	£516.25	£619.50

IA168*	1600 x 800	White	Matt	£434.00	£520.80
IAG168	1600 x 800	White	Gloss	£456.60	£547.92
IAG168B	1600 x 800	Shimmer Black	Gloss	£529.38	£635.26
IAG168W	1600 x 800	Shimmer White	Gloss	£529.38	£635.26
IAG168G	1600 x 800	Shimmer Grey	Gloss	£529.38	£635.26

QUADRANT					
IA9Q*	900 x 900	White	Matt	£311.94	£374.33
IAG9Q	900 x 900	White	Gloss	£334.54	£401.45
IAG9QB	900 x 900	Shimmer Black	Gloss	£411.25	£493.50
IAG9QW	900 x 900	Shimmer White	Gloss	£411.25	£493.50
IAG9QG	900 x 900	Shimmer Grey	Gloss	£411.25	£493.50

900 x 900mm Quadrant

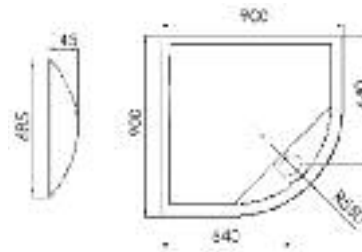

*** Anti Slip Trays**

Matt Trays have been tested to:

BS7679-2:2002+A1:2013 -Slip potential - low DIN 51097:1992 Class C

Anti-Slip Trays



Our collection of Solid Surface Shower Trays offers a stylish finish, with a domed aluminium waste cover. The low profile trays are self-reinforcing so can be laid directly down to joists and then tiled up to, achieving a level access wetroom look. They are available in matt white or grey which has been approved for Anti-Slip properties. For volume orders we can accommodate a variety of colour finishes and sizes to your specification, including stone effect finishes to coordinate your bathroom design.



Grey Anti-Slip Tray

1200 x 800mm

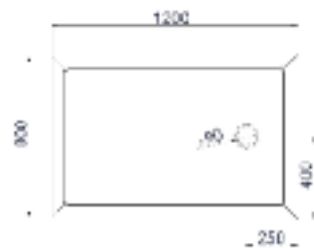

1200 x 900mm

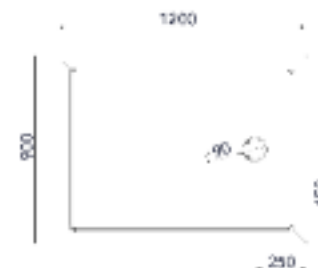

1400 x 900mm

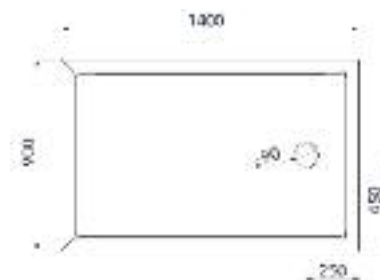

1500 x 800mm

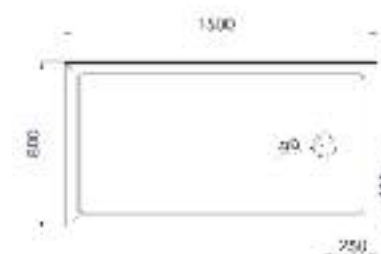

1600 x 800mm

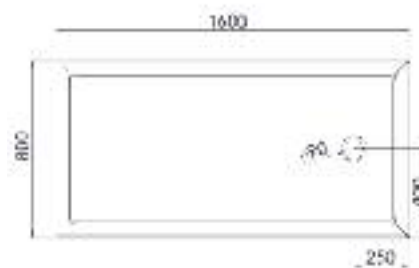

1700 x 800mm



Features and Benefits:

- Ultra low 40mm profile
- Manufactured using Roman Stone solid surface technology
- One angle of slope to waste to maximise flow rating
- Fast flow waste included
- Solid Surface Plinth and Leg Set available if required

*** Anti Slip Trays**

Matt Trays have been tested to:
BS7679-2:2002+A1:2013 -Slip potential - low DIN 51097:1992 Class C

Size (mm)	Description	White Code	Grey Code	Finish	£ ex vat	£ inc vat
1200 x 800	Anti-Slip Tray	RST128	RST128MG	Matt	£326.19	£391.43
1200 x 900	Anti-Slip Tray	RST129	RST129MG	Matt	£339.75	£407.70
1400 x 900	Anti-Slip Tray	RST149	RST149MG	Matt	£380.44	£456.53
1500 x 800	Anti-Slip Tray	RST158	RST158MG	Matt	£387.00	£464.40
1600 x 800	Anti-Slip Tray	RST168	RST168MG	Matt	£394.00	£472.80
1700 x 800	Anti-Slip Tray	RST178	RST178MG	Matt	£401.00	£481.20

Plinth and Leg Set

Standard Riser Kit	RSTRK01	RSTRK02	Matt	£127.08	£152.50
--------------------	---------	---------	------	---------	---------



Chrome plated domed waste



Tray with Leg Kit



Tray with Plinth

Features and Benefits:

- Ultra low profile
- Gloss or Matt* finish available in white
- Shimmer options in gloss only
- Manufactured using Roman Stone Solid Surface Technology

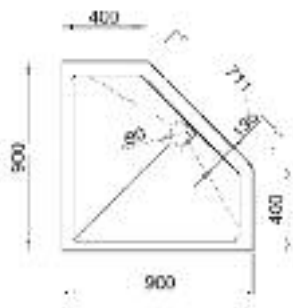

DNT9

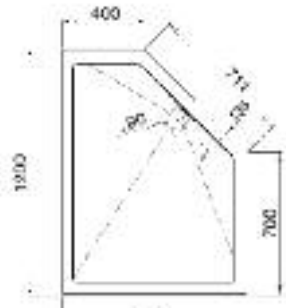

DNT129 Right Hand

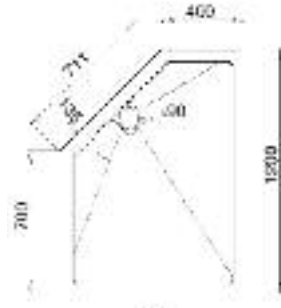

DNT129 Left Hand

LH = Left Hand RH = Right Hand

Code	Size (mm)	Colour	Finish	£ ex vat	£ inc vat
DNT9*	900	White	Matt	£280.00	£336.00
DNTG9	900	White	Gloss	£301.88	£362.26
DNT129L*	1200 x 900 LH	White	Matt	£345.63	£414.76
DNTG129L	1200 x 900 LH	White	Gloss	£367.50	£441.00
DNT129R*	1200 x 900 RH	White	Matt	£345.63	£414.76
DNTG129R	1200 x 900 RH	White	Gloss	£367.50	£441.00
DNT9B	900	Shimmer Black	Gloss	£389.38	£467.26
DNT129LB	1200 x 900 LH	Shimmer Black	Gloss	£455.00	£546.00
DNT129RB	1200 x 900 RH	Shimmer Black	Gloss	£455.00	£546.00
DNT9W	900	Shimmer White	Gloss	£389.38	£467.26
DNT129LW	1200 x 900 LH	Shimmer White	Gloss	£455.00	£546.00
DNT129RW	1200 x 900 RH	Shimmer White	Gloss	£455.00	£546.00
DNT9G	900	Shimmer Grey	Gloss	£389.38	£467.26
DNT129LG	1200 x 900 LH	Shimmer Grey	Gloss	£455.00	£546.00
DNT129RG	1200 x 900 RH	Shimmer Grey	Gloss	£455.00	£546.00

* Anti Slip Trays

Matt Trays have been tested to:

BS7679-2:2002+A1:2013 -Slip potential - low DIN 51097:1992 Class C



Waste Dimensions



Neo Angle Trays

An angled design to fit flawlessly with the dedicated enclosures. It is manufactured from Roman Stone using Solid Surface Technology and incorporates a stylish chrome waste – presenting a sublime finish. When installed it offers a small step into the showering area. The dedicated Neo Angle Tray is suitable for use with power shower systems and carries away 25 litres of water per minute.



Lumin8 Trays

Roman's Lumin8 range of enclosures feature product specific low level trays manufactured from Roman Stone. These level access trays incorporate a 50mm nominal profile which when installed create a simulated wetroom look. The Lumin8 Tray range is suitable for use with power shower systems and carries away 25 litres of water per minute.



*** Anti Slip Trays**

Matt Trays have been tested to:

BS7679-2:2002+A1:2013 - Slip potential - low DIN 51097:1992 Class C



Features and Benefits:

- Level access tray
- 50mm nominal height
- Roman Stone Solid Surface Technology
- Gloss gel coated surface and matt satin options
- Includes chrome grid waste and fast flow trap
- Suitable for use with power shower systems rated up to 25 litres per minute



Lumin8 Tray Waste Dimensions

Lumin8 1700 Colossus Tray - see pages 75 - 76

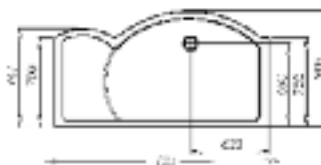

Left Hand Low Level Tray - FC1L

Must indicate left or right handing e.g. FC1L or FC1R

Lumin8 1450 Colossus Tray - see pages 77 - 78



Left Hand Low Level Tray - FCT1L

Must indicate left or right handing e.g. FCT1L or FCT1R

Lumin8 Wave Walk-in Tray - see pages 79 - 80

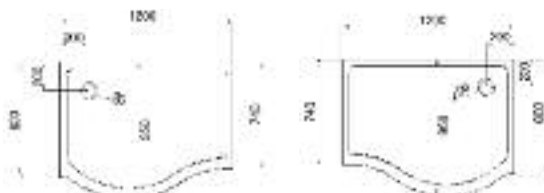

Left Hand Low Level Tray - 1200 x 800

Right Hand Low Level Tray - 1200 x 800

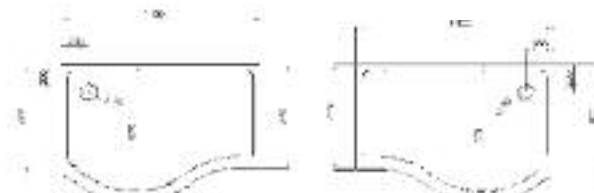

Left Hand Low Level Tray - 1400 x 800

Right Hand Low Level Tray - 1400 x 800

LH = Left Hand RH = Right Hand

Code	Size (mm)	Colour	Finish	£ ex vat	£ inc vat
FC1	1700 x 700	White	Matt	£474.69	£569.63
FCG1	1700 x 700	White	Gloss	£497.29	£596.75
FCG1LB	1700 x 700 LH	Shimmer Black	Gloss	£568.75	£682.50
FCG1RB	1700 x 700 RH	Shimmer Black	Gloss	£568.75	£682.50
FCG1LW	1700 x 700 LH	Shimmer White	Gloss	£568.75	£682.50
FCG1RW	1700 x 700 RH	Shimmer White	Gloss	£568.75	£682.50
FCG1LG	1700 x 700 LH	Shimmer Grey	Gloss	£568.75	£682.50
FCG1RG	1700 x 700 RH	Shimmer Grey	Gloss	£568.75	£682.50
FCT1	1450 x 700	White	Matt	£461.13	£553.36
FCTG1	1450 x 700	White	Gloss	£483.73	£580.48
FCTG1LB	1450 x 700 LH	Shimmer Black	Gloss	£555.63	£666.76
FCTG1RB	1450 x 700 RH	Shimmer Black	Gloss	£555.63	£666.76
FCTG1LW	1450 x 700 LH	Shimmer White	Gloss	£555.63	£666.76
FCTG1RW	1450 x 700 RH	Shimmer White	Gloss	£555.63	£666.76
FCTG1LG	1450 x 700 LH	Shimmer Grey	Gloss	£555.63	£666.76
FCTG1RG	1450 x 700 RH	Shimmer Grey	Gloss	£555.63	£666.76
V8STL	1200 x 800 LH	White	Matt	£354.38	£425.26
V8STGL	1200 x 800 LH	White	Gloss	£376.25	£451.50
V8STR	1200 x 800 RH	White	Matt	£354.38	£425.26
V8STGR	1200 x 800 RH	White	Gloss	£376.25	£451.50
V8STGLB	1200 x 800 LH	Black Shimmer	Gloss	£463.75	£556.50
V8STGRB	1200 x 800 RH	Black Shimmer	Gloss	£463.75	£556.50
V8STGLW	1200 x 800 LH	White Shimmer	Gloss	£463.75	£556.50
V8STGRW	1200 x 800 RH	White Shimmer	Gloss	£463.75	£556.50
V8STGLG	1200 x 800 LH	Grey Shimmer	Gloss	£463.75	£556.50
V8STGRG	1200 x 800 RH	Grey Shimmer	Gloss	£463.75	£556.50
V8ST14L	1400 x 800 LH	White	Matt	£404.38	£485.26
V8ST14GL	1400 x 800 LH	White	Gloss	£404.38	£485.26
V8ST14R	1400 x 800 RH	White	Matt	£426.25	£511.50
V8ST14GR	1400 x 800 RH	White	Gloss	£426.25	£511.50
V8ST14GLB	1400 x 800 LH	Black Shimmer	Gloss	£513.75	£616.50
V8ST14GRB	1400 x 800 RH	Black Shimmer	Gloss	£513.75	£616.50
V8ST14GLW	1400 x 800 LH	White Shimmer	Gloss	£513.75	£616.50
V8ST14GRW	1400 x 800 RH	White Shimmer	Gloss	£513.75	£616.50
V8ST14GLG	1400 x 800 LH	Grey Shimmer	Gloss	£513.75	£616.50
V8ST14GRG	1400 x 800 RH	Grey Shimmer	Gloss	£513.75	£616.50

Bow Fronted Quadrant Trays

To suit Lumin8 Curved Quadrants we offer our elegant Gloss trays, which have been manufactured using Roman Stone, Solid Surface Technology. These minimalistic low level trays incorporate a gel coating to give a superior high gloss finish.

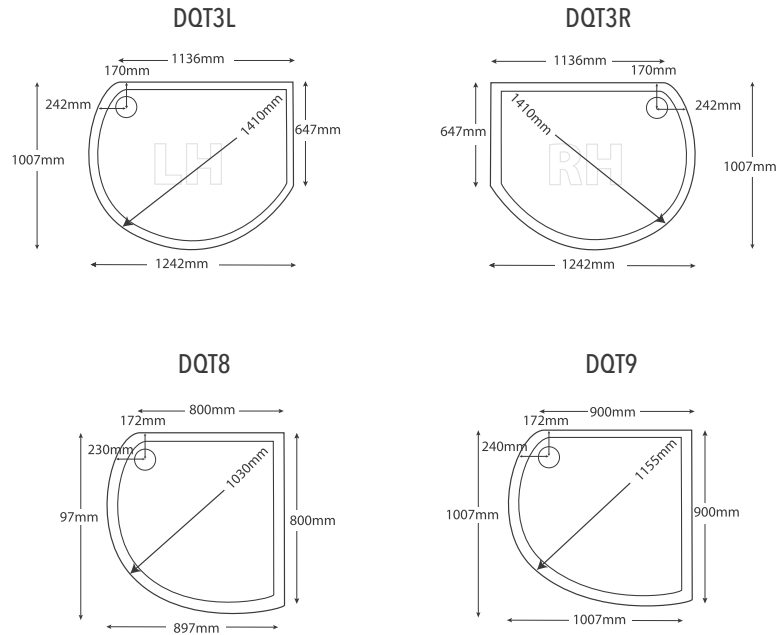

LH = Left Hand RH = Right Hand

Code	Colour	Finish	£ ex vat	£ inc vat
DQT3L	White LH	Gloss	£299.75	£359.70
DQT3R	White RH	Gloss	£299.75	£359.70
DQT3LB	Shimmer Black LH	Gloss	£387.25	£464.70
DQT3RB	Shimmer Black RH	Gloss	£387.25	£464.70
DQT3LW	Shimmer White LH	Gloss	£387.25	£464.70
DQT3RW	Shimmer White RH	Gloss	£387.25	£464.70
DQT3LG	Shimmer Grey LH	Gloss	£387.25	£464.70
DQT3RG	Shimmer Grey RH	Gloss	£387.25	£464.70
DQT8	White	Gloss	£214.14	£256.97
DQT8B	Shimmer Black	Gloss	£301.64	£361.97
DQT8W	Shimmer White	Gloss	£301.64	£361.97
DQT8G	Shimmer Grey	Gloss	£301.64	£361.97
DQT9	White	Gloss	£226.02	£271.22
DQT9B	Shimmer Black	Gloss	£313.52	£376.22
DQT9W	Shimmer White	Gloss	£313.52	£376.22
DQT9G	Shimmer Grey	Gloss	£313.52	£376.22



Features and Benefits:

- 50mm nominal height
- 90mm waste trap
- Manufactured using Roman Stone - Solid Surface Technology
- Gloss gel coated surface
- Must indicate left or right handing of DQT3 tray e.g. DQT3/L or DQT3/R

Roman Trays

Acrylic Capped Stone

In its diverse range of footprints and gloss finish, the Roman Tray range perfectly complements our diverse range of shower enclosures to deliver something truly stunning and unique for every installation. The power shower approved, easy clean, 90mm rapid drain outlet works with the sleek lines of the tray, allowing up to 32 litres of water to be carried away per minute. Incorporating a 40mm profile, the Roman Tray when installed offers a small step into the shower enclosure. Manufactured from composite resin capped acrylic it is easy to install as it offers the option of flat to floor or raised on legs installation.



- Low profile - only 40mm in height
- Available with optional leg kits to create raised version
- Manufactured from a composite resin capped acrylic
- Gloss finish
- Height of panel kits 95mm
- 90mm Domed Waste included

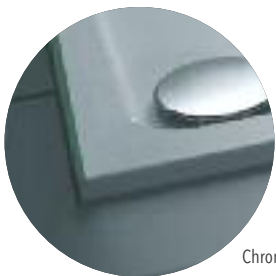

Chrome plated domed waste

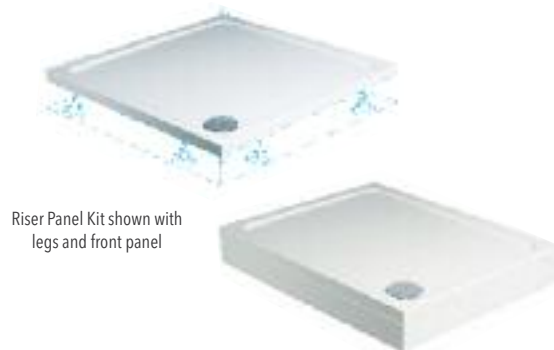

Riser Panel Kit shown with legs and front panel



Square

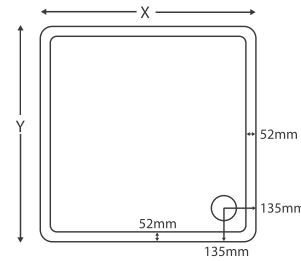

Rectangle

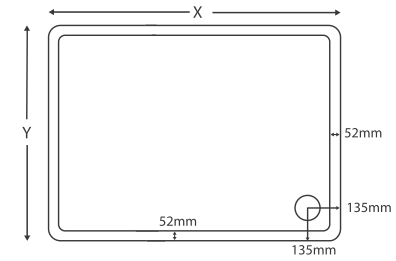

Code	Size	OPTIONAL Riser Panel Kit (see below)	£ ex vat	£ inc vat
	X Y			

Roman Square Tray

RLT76	760mm	x	760mm	RTPK03	£108.00	£129.60
RLT80	800mm	x	800mm	RTPK03	£125.00	£150.00
RLT90	900mm	x	900mm	RTPK03	£170.00	£204.00
RLT100	1000mm	x	1000mm	RTPK04	£270.00	£324.00

Roman Rectangle Tray

RLT79	900mm	x	760mm	RTPK03	£180.00	£216.00
RLT107	1000mm	x	760mm	RTPK03	£185.00	£222.00
RLT108	1000mm	x	800mm	RTPK03	£200.00	£240.00
RLT109	1000mm	x	900mm	RTPK03	£205.00	£246.00
RLT118	1100mm	x	800mm	RTPK03	£205.00	£246.00
RLT119	1100mm	x	900mm	RTPK03	£205.00	£246.00
RLT127	1200mm	x	760mm	RTPK03	£195.00	£234.00
RLT128	1200mm	x	800mm	RTPK03	£195.00	£234.00
RLT129	1200mm	x	900mm	RTPK03	£220.00	£264.00
RLT149	1400mm	x	900mm	RTPK04	£315.00	£378.00
RLT158	1500mm	x	800mm	RTPK04	£355.00	£426.00
RLT168	1600mm	x	800mm	RTPK04	£390.00	£468.00
RLT178	1700mm	x	800mm	RTPK04	£410.00	£492.00

RTPK03	1200mm Square / Rectangle Panel Kit + feet	£75.00	£90.00
RTPK04	1800mm Rectangle Panel Kit + feet	£75.00	£90.00

RTW	Roman Tray Waste (90mm)	£30.00	£36.00
-----	-------------------------	--------	--------

Quadrant

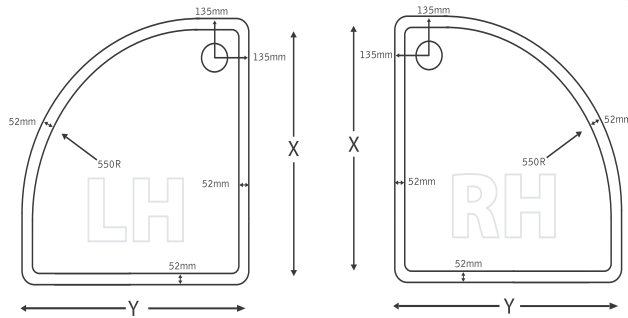
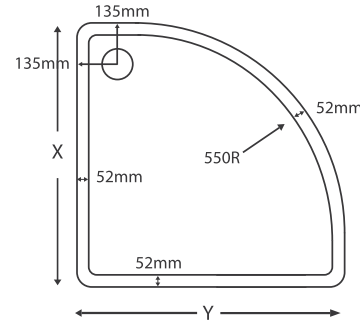

* Left or right handing must be specified

Code	Size	OPTIONAL Riser Panel Kit (see below)	£ ex vat	£ inc vat
	X Y			
Roman Quadrant Tray				
RLQ80	800mm x 800mm	RTPK01	£155.00	£186.00
RLQ89L*	900mm x 800mm LH	RTPK01	£190.00	£228.00
RLQ89R*	900mm x 800mm RH	RTPK01	£190.00	£228.00
RLQ90	900mm x 900mm	RTPK01	£190.00	£228.00
RLQ976L*	900mm x 760mm LH	RTPK02	£215.00	£258.00
RLQ976R*	900mm x 760mm RH	RTPK02	£215.00	£258.00
RLQ100	1000mm x 1000mm	RTPK01	£230.00	£276.00
RLQ108L*	1000mm x 800mm LH	RTPK02	£245.00	£294.00
RLQ108R*	1000mm x 800mm RH	RTPK02	£245.00	£294.00
RLQ128L*	1200mm x 800mm LH	RTPK02	£305.00	£366.00
RLQ128R*	1200mm x 800mm RH	RTPK02	£305.00	£366.00
RLQ129L*	1200mm x 900mm LH	RTPK02	£305.00	£366.00
RLQ129R*	1200mm x 900mm RH	RTPK02	£305.00	£366.00
RTPK01	Quadrant Panel Kit + feet		£75.00	£90.00
RTPK02	Off Set Quadrant Panel Kit + feet		£75.00	£90.00
RTW	Roman Tray Waste (90mm)		£30.00	£36.00

Roman Anti Slip Kit

Roman Anti Slip Coating now available in a pack.

This kit allows for an anti-slip coating to be applied only on Acrylic Capped Roman Stone shower trays which will aid the prevention of slips and falls in wet & dry conditions.

This product conforms to BS7976-2:2002 achieving a low slip potential within wet conditions and conforms to DIN 51097 with a class C slip rating. Independently UK tested and approved.



Anti Slip Advantages:

- Added reassurance in wet showers
- Easy to apply
- Hygienic and low maintenance
- Resilient and durable
- Solvent free
- Colourless

Possible Areas of Use:

- Shower trays
- Retirement homes and nursing homes
- Clinics and rehabilitation facilities
- Only for use with Roman Acrylic Capped Stone Trays



Code	Description	£ ex vat	£ inc vat
RTAS01	Anti Slip Coating Pack	£70.00	£84.00



■ Lumin8 Inward Folding Bath Screen V8BV13S

See page 134 for more details



Bath Screens

Bath Screens continue to be a very popular choice as around 65% of UK bathrooms have showering facilities over the bath, due to the shrinking size of UK bathroom and the growing popularity of multiple bathrooms in the family home.

Many homes in the UK now have two or three bathrooms, which tend to be smaller and more compact as opposed to a spacious family bathroom. Due to this Bath Screens have increased in popularity as they are often specified for the main family bathroom to give an additional showering facility, which helps to overcome the morning rush to the shower. Combi-boilers and higher pressure plumbing systems have now created a demand for power shower approved bath screens.

Roman's extensive range of Bath Screens offers something to suit everyone's requirements and style of bathroom. We offer a range of sizes, shapes, glass thicknesses and styles designed to fit around any existing bathroom fixtures and fittings. Our range includes power shower approved bath screens for a superior showering experience, which incorporate a unique seal system for added water integrity.

Bath Screens

10mm

Decem^x Hinged Bath Screen

Indulgent over bath design. Power Shower approved for uncompromised showering. Outward opening for easy access. Self-closing Hinges. Choose from curved or straight hinges. Water Safe System for maximum water integrity.

Features and Benefits:

- 10mm glass
- Glass height - 1500mm
- Self-closing hinges
- Choice of curved or straight chromed brass hinges
- Outward opening for ease of cleaning
- Integrated 'bathtop' Water Safe System for excellent water integrity
- Suitable for use with power showers
- Roman Ultra Care glass protection included
- 15mm of adjustment in each minimal wall profile for easy installation
- Reversible for left or right hand fitting



Curved Hardware



Square Hardware



- Bath Screen DXBLB
- Shower Basket RSB02

Bath Screen (mm)	Hardware Style	Adjustment (mm)	Cost ex VAT	Cost inc VAT	Order Code required:
830	Curved	815 - 830	£495.83	£595.00	DXBLA
830	Square	815 - 830	£495.83	£595.00	DXBLB

Features and Benefits:

- 8mm glass
- 1500mm high
- Chromed brass hinges
- Bright silver frame
- Power shower approved with unique seal system
- 25mm vertical adjustment in each profile
- Glass pre-coated with Roman Ultra Care
- V8B13S - reversible for left or right hand fixing
- V8BL13S - left or right handing must be specified



Lumin8 Frameless Bath Screens



These Luxury 8mm thick glass bathscreens present a minimalist designer look. Power Shower approved with unique seal system for use with pumped and pressurised water systems, for an indulgent showering experience. The outward opening panel makes it easy access for cleaning. Designed to work around your existing fixtures and fittings.

The Frameless Hinged Screen features stylish chromed hinges. Once again power shower approved but offering a different styling option with luxury hinges to provide a superior showering experience.



- Lumin8 Frameless Hinged Bath Screen V8BL13SR
- Shower Basket RSB06



- Lumin8 Frameless Bath Screen V8B13S
- Shower Basket RSB06

Code	Description	Size (mm)	Adjustments (mm)	£ ex vat	£ inc vat
V8B13S	Frameless Bath Screen	835	810 - 835	£275.00	£330.00
V8BL13S	Frameless Hinged Bath Screen	835	810 - 835	£320.84	£385.01

N.B. Please indicate left or right handing when order V8BL13S e.g. V8BL13SL or V8BL13SR



Lumin8 Inward Folding Bath Screen

Power shower approved for an uncompromised showering experience. Designed with discreet profiling and indulgent 8mm thick toughened glass. This bath screen features one fixed panel and one inward opening panel. Cleverly designed to avoid your existing fittings.

Features and Benefits:

- 8mm glass
- Height: 1500mm
- Frame: Silver
- Vertical adjustment: 25mm
- Horizontal PVC seal and vertical magnetic seals
- Inward opening only
- Fixed panel and pivoting screen
- Bath top aluminium seal for added water integrity
- Suitable for use with power showers



Lumin8 Folding Bath Screen in closed position.



- Lumin8 Folding Bath Screen OBV13SL
- Shower Basket RSB05



Left Hand

Right Hand

As used in top hotels all over the world

Code	Width Open Size (mm)	Width Closed Size (mm)	Adjustment (mm)	£ ex vat	£ inc vat
OBV13S	910	520	885 - 910	£453.43	£544.12

Must indicate left or right handing of bath screen e.g. OBV13SR or OBV13SL.

Features and Benefits:

- 8mm glass
- Height: 1500mm
- Adjustment 885 - 910mm
- Outward opening (hinges stop at 90° to avoid contact with basins and furniture)
- Optional Bracing Bar included
- Bath top aluminium seal for added water integrity
- Power shower approved

Lumin8

Outward Folding Bath Screen



8mm thick toughened glass for a substantial finish. Minimalist framing for a designer look. The bath screen features one fixed panel and one outward opening panel. Designed to work around your existing fixtures and fittings. Power shower approved for an indulgent showering experience.

Choose the screen which best suits your bathroom requirements

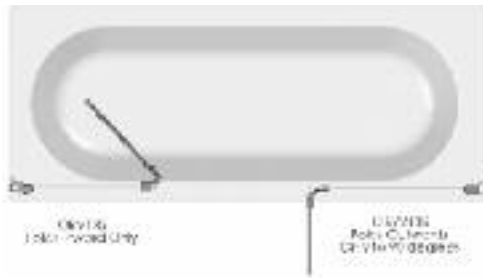

OBV213SL - Left Hand illustration

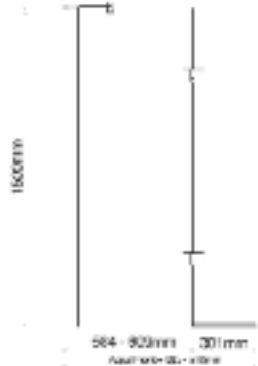

Please note this outward opening panel stops at 90° to avoid colliding with any furniture - ideal for small compact bathrooms and hotel rooms



Lumin8 Outward Folding Bath Screen OBV213SL in open position



■ Lumin8 Outward Folding Bath Screen OBV213SL

Code	Width Closed (mm)	Width Open (mm)	Adjustment (mm)	£ ex vat	£ inc vat
OBV213S	910	620	885 - 910	£453.43	£544.12

Must indicate left or right handing of bath screen e.g. OBV213SR or OBV213L

Lumin8 Concealed Fix Bath Screens

The OBV3 Bath Screen presents a truly minimalist design with its concealed profile, whilst also providing water integrity with its reliable integrated 'bath top' seal. The outward folding Bath Screen incorporates one fixed panel and one opening panel to offer easy access cleaning. The clever opening panel stops at 90° to avoid bathroom fixtures and fittings.

The OBV4 power shower approved Bath Screen provides an exceptional over the bath showering experience. The inward folding Bath Screen incorporates toughened 8mm thick glass and a concealed fix profile system to present a minimalist designer look. The Bath Screen includes one fixed panel and one inward pivoting panel to allow easy entry into the bath and easy access cleaning.

Features and Benefits:

- 8mm glass
- Height: 1500mm
- Concealed fix profile system
- Fixed panel and hinge screen
- Horizontal PVC seal and vertical magnetic seals
- OBV3 - Outward opening (hinges stop at 90° to avoid contact with basins and furniture)
- OBV4 - Inward opening only
- Optional Bracing Bar included with OBV3
- Bath top aluminium seal for added water integrity
- Suitable for use with power showers

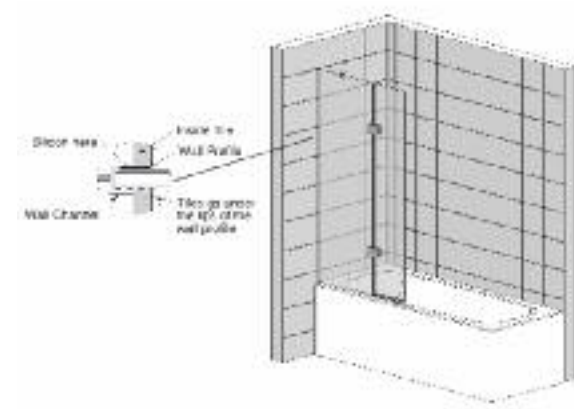

Hinges stop at 90°



Optional Bracing Bar included



Bath top aluminium seal for added water integrity

- Lumin8 Outward Opening Concealed Fix Bath Screen OBV3
- Shower Basket RSB02

Code	Description	Width Open (mm)	Width Closed (mm)	Adjustment (mm)	£ ex vat	£ inc vat
OBV313S	Outward Opening	540	850	832 - 850	£453.43	£544.12
OBV413S	Inward Opening	850	450	832 - 850	£453.43	£544.12

Must indicate left or right handing of bath screen e.g. OBV313SL or OBV313SR.

Features and Benefits:

- 8mm glass
- 1500mm high
- Bright silver frame
- Power shower approved
- 25mm vertical adjustment in each profile
- Glass pre-coated with Roman Ultra Care

Lumin8 Inward Folding Bathscreen



Featuring 8mm thick glass with one fixed panel and one inward folding panel, providing easy entry into the bath for showering and cleaning. Its discreet nature makes sure it avoids contact with all existing bathroom furniture, making it the ideal space saving solution for the smaller bathroom.



Code	Description	Width Closed (mm)	Width Open (mm)	Adjustment (mm)	£ ex vat	£ inc vat
V8BV13S	Inward Opening	885 - 910	525 - 550	885 - 910	£295.83	£355.00

■ Lumin8 Inward Folding Bath Screen V8BV13S

8mm

Lumin8 Fixed Bath Screen

A simple and stylish 8mm thick glass bath screen which will compliment any bathroom. It is power shower approved, so you can have a luxury showering experience over the bath. It is minimalist with one fixed panel and an optional bracing bar if added support is required. It offers superior water integrity, whilst maintaining its minimal design.

Features and Benefits:

- 8mm glass
- 1467mm high
- Bright silver frame
- Suitable for use with power showers
- 25mm vertical adjustment
- Glass pre-coated with Roman Ultra Care
- Reversible for left or right applications
- Optional brace bar included
- Fixed Screen
- For use when inward or outward function is not possible due to site conditions



■ Lumin8 Fixed Bath Screen V8BS13S



■ Shower Basket RSB06

Code	Description	Width (mm)	Adjustment (mm)	£ ex vat	£ inc vat
V8BS13S	Fixed Bath Screen	800	783 - 808	£216.67	£260.00

Features and Benefits:

- 6mm glass
- 1467mm high
- Bright Silver Frame
- Frameless glass
- Reversible for left or right hand applications
- Suitable for use with power showers
- 25mm vertical adjustment
- Fixed Screen
- Optional brace bar included
- For use when inward or outward function is not possible due to site conditions



■ Shower Basket RSB04

Code	Description	Width (mm)	Adjustment (mm)	£ ex vat	£ inc vat
EBS13S	Fixed Bath Screen	800	787 - 812	£183.33	£220.00

Embrace Fixed Bath Screen

6mm

You can have an indulgent over the bath shower with this power shower approved bath screen. It features one fixed panel with 6mm thick glass and an optional bracing bar is available for extra support. It is ideal as a space saving product as it doesn't protrude into the existing bathroom space and it is exceptionally water tight.



■ Embrace Fixed Bath Screen EBS13S

6mm

Embrace Bath Screen

Available in clear or frosted glass this bath screen features a unique sealing system between to ensure areas prone to leakage remain water tight, whilst still allowing 180° movement of the glass panel.

Features and Benefits:

- 6mm glass clear or frosted
- Height: 1500mm
- Frame: Silver
- Reversible for left or right hand fixing
- Unique sealing system between vertical and horizontal aluminium
- Suitable for use with power showers
- EB213S suitable for use with smaller baths (i.e. 1500mm)



■ Embrace Bath Screen EB13S
■ Shower Basket RSB04



■ Embrace Bath Screen EB99S

Code	Width (mm)	Glass	Adjustment (mm)	£ ex vat	£ inc vat
EB13S	820	Clear	810 - 835	£235.26	£282.31
EB213S	700	Clear	678 - 703	£235.26	£282.31
EB99S	820	Frosted	810 - 835	£279.57	£335.48

Features and Benefits:

- 6mm glass
- Height 1500mm
- Frame: Silver
- Width: open 525-550mm/closed 885-910mm
- Frameless with radius glass
- Reversible for left or right hand applications
- Suitable for use with power showers
- Optional brace bar included

Embrace Inward Folding Bath Screen

The clean lines and easy folding system of this power shower approved Folding Screen make it perfect solution for over the bath showering. It offers ease of access to the full length of the bath.

6mm



Code	Description	Width (mm)	Frame	Adjustment (mm)	£ ex vat	£ inc vat
EBV213S	Inward Folding Screen	910	Silver	885 - 910	£227.61	£273.13

■ Embrace Inward folding Bath Screen EBV213S

6mm

Embrace Bath Screen Inward and Outward Folding

The dual folding mechanism provides ultimate flexibility as it allows complete access to the bath for cleaning and bathing making it a popular choice for hotel bathrooms around the world. The screen features a sealing system between the vertical and horizontal aluminium, ensuring areas prone to leakage remain water tight, whilst allowing 180° movement of the glass.



Features and Benefits:

- 6mm glass
- Height: 1500mm
- Frame: Silver
- Glass thickness: 6mm
- A. Width: 920mm when fully open
- B. Width: 520mm when in closed position 1
- C. Width: 450mm when in closed position 2
- D. Width: 430mm when in closed position 3
- Vertical adjustment: 25mm
- Full length magnetic PVC seals
- Reversible for right and left hand fixing
- Unique sealing system between the vertical and horizontal aluminium
- Suitable for use with power showers
- Optional brace bar included

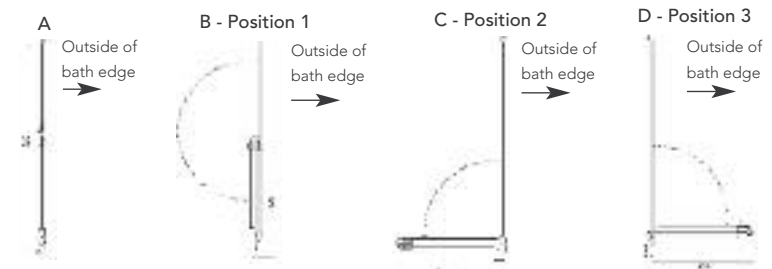

Code	Size (mm)	Adjustment (mm)	£ ex vat	£ inc vat
EBV13S	920	895-920	£406.84	£488.21

■ Embrace Folding Bath Screen EBV13S

Features and Benefits:

- 5mm glass
- Height 1500mm
- Frame: Silver or white
- Suitable for all standard bath mixer and electric showers
- Not recommended for use with pumped or pressurised systems
- Vertical and horizontal PVC seals
- Reversible for left or right hand fixing



■ Shower Basket RSB02

Code	Description	Frame	Adjustment (mm)	£ ex vat	£ inc vat
CB13S	Screen with curved corner	Silver	810 - 825	£150.84	£181.01
CB13W	Screen with curved corner	White	810 - 825	£150.84	£181.01

Collage Curved Bath Screen

The elegant Collage curved Bath Screen presents a stylish over the bath showering solution with its curved design. It pivots through 180°, which allows for easy access and cleaning. It provides complete water integrity with its colourless PVC strip for a watertight seal.

5mm



■ Collage Curved Bath Screen CB13S
■ Shower Basket RSB02



Lumin8 Mini Fixed Bath Screen

Provides greater water integrity when using a shower curtain. The screen provides protection at the showering end of your shower curtain. It directs the water back into the showering area to improve this traditionally weak spot. The curved rail cleverly bows out to move the curtain away from the showering area to give a more comfortable and spacious showering experience.

Features and Benefits:

- 8mm glass
- Height: 1500mm
- Frame: Silver
- Suitable for all standard bath mixer and electric showers (non-pumped)
- Reversible for left or right hand fixing
- To be used in conjunction with shower curtains (no hooks or curtain supplied)
- Curved rail to increase showering comfort with a curtain



V8CC113S - The Mini-Fixed Screen complements an existing curtain rail installation and reduces splashing around the back of the curtain and water seepage along the top end of the bath.

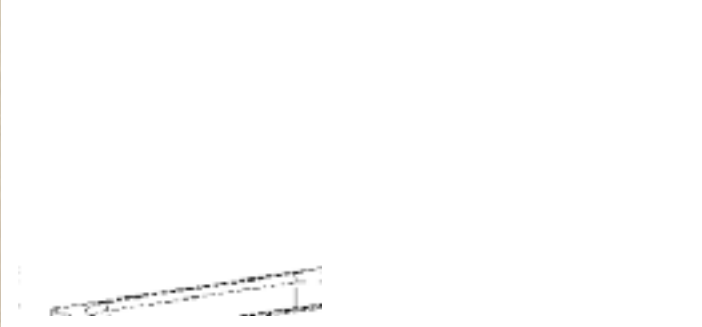

V8CC213S - The Mini-Fixed Screen complete with curtain rail (no curtain included) and wall attachments ensures a watertight shield to retain water in the bath. The curtain is held in place at the top and is less likely to allow water leakage out of the bath area. Rail length to suit 1700mm bath maximum.

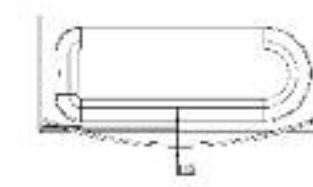

Code	Adjustment (mm)	£ ex vat	£ inc vat
V8CC113S	243 - 257	£125.00	£150.00
V8CC213S	243 - 257	£166.67	£200.00

■ Lumin8 Mini Fixed Screen with Curved Rail V8CC213S

Features and Benefits:

- 5mm glass
- Height: 1360mm
- Frame: Silver or white
- Glass thickness: 5mm
- Suitable for all standard bath mixer and electric showers
- Not recommended for use with pumped or pressurised systems
- Colourless vertical and horizontal PVC seals
- Rotates through 180° for access
- Reversible for left or right hand fitting
- Supplementary sealing kit available for added water integrity

Jupiter Bath Screens

The perfect over the bath showering solution when budget is the key requirement, our Jupiter Bath Screen is available in both a stylish curved design or a classic standard design. Due to the classic yet stylish design of both Jupiter Bath Screens they will perfectly fit in with any bathroom décor.

5mm

Code	Description	Frame	Adjustment (mm)	£ ex vat	£ inc vat
JBL13S	Standard Bath Screen	Silver	810 - 825mm	£119.19	£143.03
JBL13W	Standard Bath Screen	White	810 - 825mm	£119.19	£143.03
JB13S	Curved Bath Screen	Silver	810 - 825mm	£125.93	£151.12
JB13W	Curved Bath Screen	White	810 - 825mm	£125.93	£151.12
BSP001	Supplementary Sealing Kit			£25.00	£30.00



■ Jupiter Standard Bath Screen JBL13S



■ Jupiter Curved Bath Screen JB13W

Accessories

Roman presents a range of beautifully selected accessories to complete your bathroom. Choose from our stylish shower baskets, forged from solid brass with a contemporary chrome finish to keep your bathroom a clutter free zone. Roman also presents the Roman Shower Blade to make thorough cleaning a simple task.



■ Double Hanging Basket with Hooks RSB01

Spacers supplied so basket can be hung directly onto the glass edge



■ Large Curved Corner Basket RSB02



■ Stepped Soap Basket RSB03



■ Large 'L' Shaped Corner Basket RSB04



■ Double Corner Basket with Hooks RSB05



■ Large Rectangular Basket RSB06



■ Double Rectangular 'single wall' Basket with Hooks



■ Roman Shower Blade RSB0100
(includes spare blade part)



Practical and stylish storage



Code	Description	Dimensions	£ ex vat	£ inc vat
RSB01	Double Hanging Basket with Hooks	D: 125mm W: 220mm H: 765mm	£135.99	£163.19
RSB02	Large Curved Corner Basket	D: 224mm W: 296mm H: 73mm	£70.05	£84.06
RSB03	Stepped Soap Basket	D: 131mm W: 260mm H: 57mm & 29mm	£62.84	£75.41
RSB04	Large 'L' Shaped Corner Shower Basket	D: 115/125mm W: 255/270mm H: 99mm	£91.69	£110.03
RSB05	Double Corner Shower Basket with Hooks	D: 224mm W: 293mm H: 399mm	£118.47	£142.16
RSB06	Large Rectangular Shower Basket	D: 120mm W: 260mm H: 95mm	£70.05	£84.06
RSB07	Double Rectangular 'single wall' Shower Basket with Hooks	D: 106mm W: 215mm H: 391mm	£95.81	£114.97
RSB0100	Roman Shower Blade (includes spare blade part)	-	£27.30	£32.76

Bespoke Service

Roman offers a Bespoke Service on many of our products. So if you are looking to install a shower enclosure into an awkward or unusual space, we have the perfect solution. Roman's Bespoke Service allows you to tailor the height and width of your product, we have the option of clear, frosted or printed glass. Glass can be cut at an angle or shaped, for example angled glass can allow for a sloping roof, to make adding a showering facility to a loft conversion or under your stairs, easy.

Roman's Bespoke Service allows you to build a made to measure shower enclosure, wetroom panel or bath screen, to perfectly suit your available space.

- Made to measure items which fit almost anywhere
- All products made in accordance with your own measurements
- We endeavour to provide fast and efficient answers to all your questions
- Cost effective solutions
- Many designs to suit all tastes
- Measure and fit service available

Bespoke Services available:

- Reduced height
- Reduced width
- Clear, frosted or printed glass
- Angled/Shaped glass

To order a Bespoke Service all you have to do is simply choose which product you would like, then follow these six easy steps:

1. Take your drawings to your nearest retailer who will fax them to Roman. For your nearest retailer contact Roman Customer Relations on 01325 328033 or visit www.roman-showers.com
2. Roman will then send a quotation to your retailer for them to discuss with you
3. If you are happy with this quotation Roman will produce a drawing to illustrate what your final product will look like. **Note:** Roman will make all drawings in accordance to your measurements and unless otherwise requested, an adjustment allowance will be included. Please specify your adjustment allowance prior to ordering.
4. Roman will then fax the drawing to your retailer who will pass this on to you. This drawing will be in the form of a fax back agreement for you to sign*.
5. Once Roman receives the agreement work will begin on your product.
6. You will receive your product within 5-6 weeks.

*Once this agreement is signed you will be liable for any changes should you cancel your order.

For full pricing details and ordering process please go to:

www.roman-showers.com/roman-customers/available-downloads/



Bespoke Service

Examples of bespoke products



Pivot Door with frosted glass and In-Line Panel with Angled/Frosted glass



Corner Panel with Angled Glass without bracing



Hinged Bath Screen with Angled/Frosted glass



Folding Bath Screen with Frosted Modesty Panel

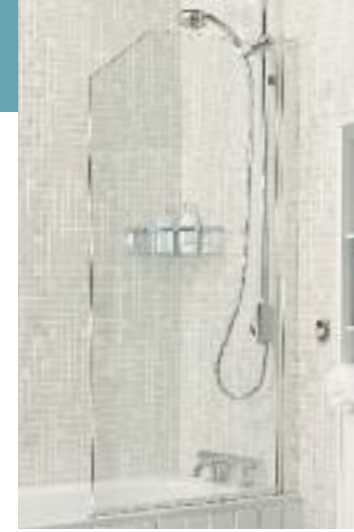

Bath Screen with Angled Glass



Hinged Door with angled glass



Reduced height Hinged Door with frosted glass and Side Panel with angled/frosted glass



Bi-Fold Door with frosted glass and Side Panel with frosted glass



Bi-Fold Door with angled In-Line Panel



Bi-Fold Door and Side Panel with Frosted Modesty Panels

Glass Protection

The Ultimate Bathroom Protector on glass

All Roman's enclosures and bath screens are pre-coated with Roman Ultra Care, our own unique glass protection system. Pre-coated glass protection systems will always diminish in their effectiveness over time, depending on how often the shower is used and how often it is cleaned. Unlike other systems, Roman Ultra Care in a bottle can be used in tandem with the pre-coat to build up the effectiveness and make it stronger the more you clean. Roman Ultra Care is an award winning bathroom protector and has a 10 year track record for successfully protecting Roman's extensive product range. When applied to the glass of an enclosure or bath screen it creates a chemical barrier which provides protection against the build-up of grime, limescale and stains. The protective barrier means water glides off the glass with ease. This results in the protected surface remaining easy to clean by simply applying a mild detergent and wiping with a damp cloth or using a Roman Shower Blade.

By topping up the glass protection system with Roman Ultra Care in a bottle every time you clean, you can significantly reduce the amount of time required to clean your enclosure and bathroom surfaces. Most importantly, you can considerably prolong the life of your Roman product and at the same time do your bit for the environment by eliminating the use of harsh and damaging cleaning products.



For details of your nearest stockist please contact Roman Customer Relations on 01325 328033 or buy online at www.romanathome.com



Winner of the House Beautiful Best Cleaning Product Award 2009

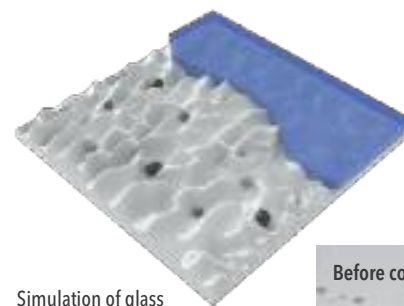

Simulation of glass surface magnified

All glass surfaces have a non smooth finish which can attract the build-up of particles. Roman Ultra Care provides an invisible protective film which seamlessly seals the surface to ensure this build-up does not bond to the glass and the glass retains its optical clarity for lasting sparkle.

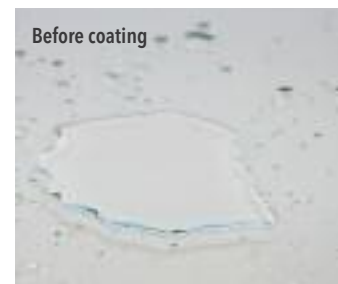

Before coating

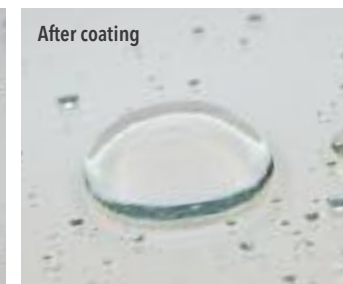

After coating

Ongoing After Care

To maintain the long lasting sparkle of your Roman enclosure or bath screen and aid the Ultra Care pre-coated glass protection; Roman Ultra Care can be purchased in a user friendly 750ml sized bottle. This can be purchased for only £14.95 from your local Roman Bathroom Retailer, or alternatively from www.romanathome.com

Roman Ultra Care is not limited to the cleaning and protection of your shower enclosure or bath screen, it can also be used to protect other bathroom surfaces, which are not pre-coated, including glass, tiles, aluminium frames, taps, trays, sinks and baths.

Simply wipe down your bathroom surfaces after use and apply Roman Ultra Care with a soft cloth.

Roman Ultra Care can be used weekly as part of your bathroom cleaning routine.

The more you apply Roman Ultra Care the more protection you create for your enclosure, therefore your enclosure will maintain its high quality finish for longer. Without using Roman Ultra Care, your pre-coated glass protection will diminish over time.

Important information to help you maintain your Roman product:

Ensure you clean your product using a mild detergent diluted in water and then polish off using a soft damp cloth. Apply a coat of Roman Ultra Care after each clean to build-up the protective film on the surface.

If you live in a hard water area, periodically clean your product using a 50/50 solution of white vinegar and water. The solution should be left on the enclosure for approximately 5 minutes then rinsed off using warm water.

1. Do not use acidic based products which are unsuitable for cleaning enamel surfaces.
2. Do not use abrasive cleaners or cleaners containing bleach or solvents, these products will adversely affect the finish of the aluminium profiles.
3. Do not use scouring pads, powder or any sharp instruments when cleaning your Roman enclosure.

£14.95 inc VAT

(£12.46 ex VAT)

per 750ml bottle (RUC03)

The above price is for consumers only

(minimum quantity for stockists 12 bottles (RUC13))

RSB0100

Roman Shower Blade

Price £27.30 ex VAT £32.76 inc VAT



Make cleaning your bathroom easy with our

Shower, Tile and Bath

Restoration and Maintenance Kit

Restore discoloured glass and maintain the sparkle of your bathroom



CLEAN & PROTECT YOUR SHOWER IN MINUTES

ELIMINATES HARD WATER & SOAP SCUM BUILDUP

For details of your nearest stockist please contact Roman Customer Relations on **01325 328033** or buy online at **www.romanathome.com**

3 Step System includes:



Ultra Scrub Surface Stain Cleanser

Designed to effectively and easily clean your bathroom surfaces, including Glass, Porcelain, Ceramics and other hard surfaces. Developed to remove the build-up of minerals, rust, soaps, oils and limescale but without damaging the surface.



Ultra Shield Glass and Surface Stain Cleanser

Formulated to clean and protect. Ultra Shield can be used on your bathroom surfaces to create a water, soil and stain repellent barrier coating which prevents water, soil and grime from sticking for easier cleaning. This barrier is renewed with each use.



Ultra Care Glass and Surface Protector

For a long lasting sparkle on bathroom and shower surfaces. Ultra Care is the ultimate surface protector that repels the build-up. Also available in large bottle for ongoing aftercare.

Only £24.⁹⁵ inc vat

(£20.79 ex VAT) per pack (RUC14)

The above price is for consumers only (minimum quantity for stockists 12 packs RUC15)

Protecting the Environment

Roman is committed to caring for the environment and as a reflection of this commitment we became fully accredited with ISO 14001 certification in 2009. We see looking after the environment as an important part of being a UK business and UK manufacturer. As a business we care for the environment in two ways - by improving our systems to reduce our carbon footprint and impact on the environment. We strive for continual improvement in this area. For more information on how we are taking care of the environment visit our website: www.roman-showers.com and view our full list of ecodentials.



All Roman Shower Enclosures and Bath Screens and Trays are manufactured in the UK.



EMS 523823



Roman brochures are printed on stock sourced from sustainable forests.



All waste is segregated into recyclables and non-recyclables. 93% of all waste is recycled - landfill reduced to 7% of total waste generated.



All Roman Shower Enclosures, Bath Screens and Trays are manufactured in the UK. All vehicles with Euro 5 compliance engine vehicles saving 22% on emissions.

Company car policy has been updated so only vehicles with less than 125 grams of CO₂'s per Kilometre can be used in the fleet.

Overall company CO₂ reduction since 2009 is 20%.



As well as considering the environment during the manufacture of our products, we are also mindful of how our products can impact on the environment after they leave us. The addition of our Ultra Care Pre-coated Glass Protection means that dirt, grime and soap scum are washed away during the shower use. This means the use of harsh chemicals during the cleaning process can be eliminated and less water is required during the cleaning process.

Recycling your product

Packaging

As an ISO14001 Registered Company, Roman takes recycling very seriously at all levels. All cardboard is already manufactured from recycled paper, but our packaging itself is designed for recycling. Please ensure that the cardboard packaging is taken to a local cardboard recycling point or to a local recycling depot.

End of Life (EOL)

EOF recycling is taken into account from the initial design stages to ensure all aspects of the Roman products can be recycled for future use. The Aluminium, Brass Alloys, Glass (and Solid Surface Material with Roman Stone Trays) can be easily recycled at your local Licensed Recycling Centre (LRC). If you are unable to access an LRC, then Roman can arrange to coordinate a pick-up of your product for a modest transport charge.

Consumer Guide



Roman shower enclosures have been tested and fully conform to the scope and relevant characteristics of BS EN14428:2008+A1 (Shower Enclosures - Functional requirements and test methods), to meet the requirements of the mandate given under the EU Construction Product Directive (89/106/EEC).

As a result of full compliance to the directive and harmonized standard; Roman shower enclosures carry the 'CE' mark and are accompanied by a declaration of performance. (Available to view on www.roman-showers.com)

The CE marking indicates Roman shower enclosures conform to all essential requirements of European health and safety and environmental protection legislation. The conformity is mandatory, and allows Roman products to be legally placed on the market anywhere in the European Economic Area.

Additionally all Roman trays fully conform to EN14527:2006+A1 2010.

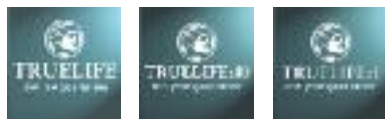

Important Product Details

- Enclosures and screens carry a Lifetime manufacturer's guarantee if products are installed according to the installation instructions - see guarantee criteria to the right.
- Simple and clear installation instructions are included with all Roman Products.
- Roman products are available for Virtual Worlds design service. For more information contact Roman Customer Relations on 01325 328033.
- Any guarantee variations are indicated separately.
- All guarantee forms supplied with installation instructions must be completed and returned to Roman within 60 days to validate the lifetime guarantee otherwise only a statutory 12 month guarantee will apply.
- All Roman Bath Screens and Enclosures are manufactured using toughened safety glass which complies to BSEN12150.
- All Roman Bath Screens and Enclosures are tested in accordance with BSEN14428 - shower enclosures, functional requirements and test methods.
- Roman's toughened glass is completely safe for use in our shower enclosures and bath screens; providing our products are installed according to our guidelines.
- It is important to note, that the glass must not be mounted or 'pinched' in such a way that would cause a stress point to develop in the glass. In addition, it must not be subjected to any sharp impact or severe temperature fluctuation which may also cause a stress point to develop in the glass.
- Roman's toughened glass is physically and thermally significantly stronger than standard glass. However a significant impact (or stress as outlined above) can cause toughened glass to break. In the event of breakage, toughened glass will break safely into small fragments in line with all relevant standards.
- All heights quoted for enclosures and bath screens are from the top of the shower tray or bath.
- All fixings are hidden on Roman products.
- The term "Silver" and "Nickel" describes the colour of the aluminium finish. No silver metal is included in any Roman products.
- All fixings and pivot pins are manufactured from stainless steel - this adds great strength and durability to Roman products.
- All seals and gaskets on Roman products are manufactured from colourless PVC.
- Roman over-bath products are not designed for baths with shaped or stepped fronts or integral soap dishes.
- The design rights of these products are owned by Roman Limited. All rights reserved.
- For compatibility of Roman enclosures with steam generators please contact Roman Customer Relations for advice on 01325 328033.
- Where indicated that products are suitable for use with steam generators, this refers to the performance of the product components. We do not however suggest that the product will have complete steam integrity.
- Due to the nature of wetroom panel products, water integrity cannot be guaranteed. Please consult your installer.

Roman have an ongoing policy of design, development and improvement and thus reserve the right to modify specification, ranges and prices without prior notice. Images are for illustration purposes only - please refer to your retailer as site conditions will vary or contact Roman Customer Relations on 01325 328033 for installation specifications.

Guarantee

Roman Ltd. guarantees all shower enclosures and bath screens against faulty materials or manufacture for LIFE, provided they have been installed, used and maintained in accordance with our instructions.

All Roman product guarantees must be completed and returned within 60 days of purchase to validate the relevant guarantee. Failure to meet this deadline will result in a statutory 1 year guarantee on all products.

Should a claim arise, Roman Ltd. Customer Relations will investigate the issue. As part of this investigation we request that the following conditions be satisfied:

1. Proof of purchase at the time of the claim.
2. The guarantee applies to the original purchaser only and is non transferable.
3. The product has been fitted / installed in accordance with Roman Ltd. fixing instructions, local bylaws and general good plumbing practice
4. The product has been maintained and cared for in accordance with our instructions (including regular and appropriate cleaning).

If in our opinion the product has been modified, misused, neglected, wilfully or accidentally damaged, we can accept no responsibility for failure.

Roman Ltd. or its representatives must be given the opportunity to inspect the product in the installed condition.

Should any products included in the lifetime guarantee be used for commercial use i.e. leisure clubs, schools, hospitals, student accommodation, hotels or residential homes, only a 5 year guarantee will be applicable.

If in our opinion the product fails due to faulty materials or manufacture and that the conditions above have been met, Roman Ltd. will arrange for a specialist Roman Technical Representative to repair or replace that item at our option.

Roman Ltd. believes in continuous improvement. If in our opinion the product has failed under the terms of the guarantee and a replacement is offered but identical goods are no longer available, Roman Ltd. will replace it with our nearest equivalent product. For countries outside of the UK and Republic of Ireland, where a product has failed due to faulty materials or manufacture, a replacement product or product part will be offered only.

Should Roman Ltd. carry out work as a result of a claim but subsequently it is revealed that the product has been abused or improperly installed, we reserve the right to charge the customer for the expense incurred.

The liability of Roman Ltd. is limited to the product supplied by Roman Ltd. and does not extend to consequential loss or damage arising from the defective product.

This guarantee, which is effective for products purchased after February 1st 2006, states our entire liability and is offered to customers acquiring our products as consumers, not in the course of trade or business. Ex displays or products reinstalled from their original position are not covered under this guarantee.

Non glass or metallic parts (e.g. seals) are subject to normal wear and tear through usage and are therefore covered on all products for 1 year from installation.

Roman Ultra Care pre-coat is not covered by this guarantee and it must be maintained by applying Ultra Care from a bottle on an ongoing basis.

Roman products not included in the lifetime guarantee include all Roman Accessories and Roman Shield® tanking products which are covered for 10 years and Roman Shower Trays which are covered for 1 year. All guarantees registered for shower enclosures or bath screens between March 1st 1998 and February 1st 2006 are subject to a 10 year guarantee.

This guarantee does not affect your statutory rights.

This guarantee is wholly applicable in the U.K. and Republic of Ireland – export conditions as indicated.

Roman Ltd
Whitworth Avenue, Aycliffe Business Park,
County Durham, DL5 6YN
Tel: 01325 311318 Fax: 01325 319889
www.roman-showers.com



Finishing touches for your home at
www.romanathome.com



ROMAN[®]
at Home

Roman would like to thank the following for their assistance with this brochure:



Tel: 020 8586 4600
www.ncdirect.co.uk

Handbasins supplied by Laufen:
Tel: 0161 765 7111
www.laufen.com

Roca bathroom furniture supplied by Roca:
Tel: 01530 830080
www.uk.roca.com

Roman Limited,
Whitworth Avenue,
Aycliffe Business Park,
County Durham,
DL5 6YN,
England, UK.

General Reception:
Phone +44 (0) 1325 311318
Fax +44 (0) 1325 319889

Customer Relations:
Phone +44 (0) 1325 328033

Sales:
Phone +44 (0) 1325 328034
Fax +44 (0) 1325 328027

www.roman-showers.com



FS 523822



EMS 523823



ROMAN
at Home

Online range of luxurious bathroom accessories and homeware products

www.romanathome.com

BCFA
member



Member of

