

Uniclass L72	EPIC H12 + H14 G611	
CI/SfB	(74) (53.9)	X

Catalogue Edition 19

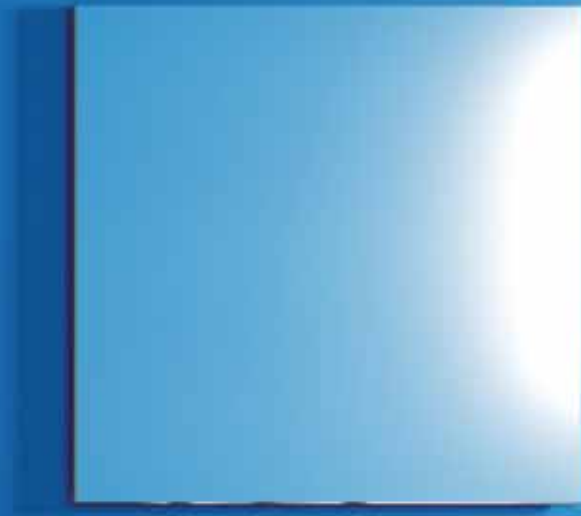

s a n e u x

WELCOME

Welcome to the Saneux Catalogue Edition 19 . . .
discover innovative design ideas for the special
place you call home.

For your convenience every item is shown including VAT.

Thank you for choosing Saneux.

Nous sommes très heureux de vous présenter la 19 édition de notre catalogue . . .
Découvrez des idées novatrices pour aménager cet endroit si spécial que vous
appelez la maison.

Tous les prix indiqués dans ce catalogue s'entendent TVA comprise.

Nous vous remercions d'avoir choisi Saneux.



Pictured: INDIGO washbasin and unit with matching tall-side unit.



CONTACT US

United Kingdom sales@saneux.com

Freephone: 0800 1973 800 (UK only)

Office phone: +44 (0) 20 8686 5100

Office Fax: +44 (0) 20 8680 3187

France france@saneux.com

Office phone: +33 4 75 43 85 97

www.saneux.com



Pictured: LOLA free-standing bath with TEMPUS free-standing bath/shower mixer.

CONTENTS

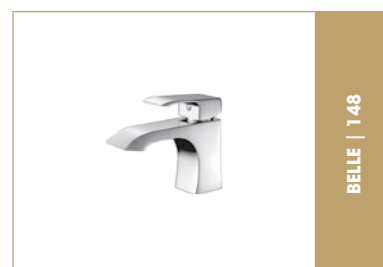
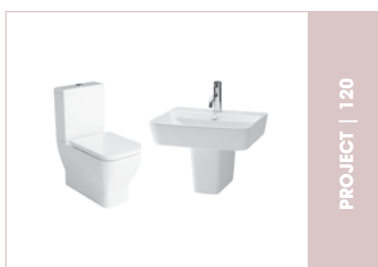
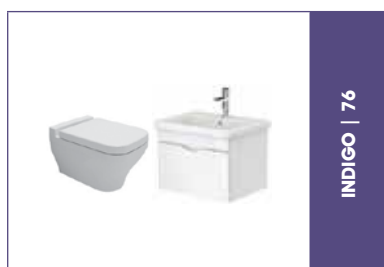
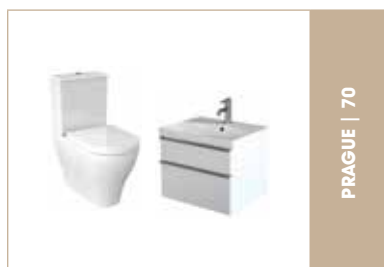
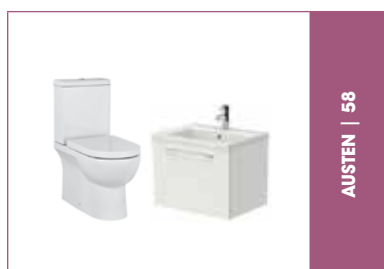
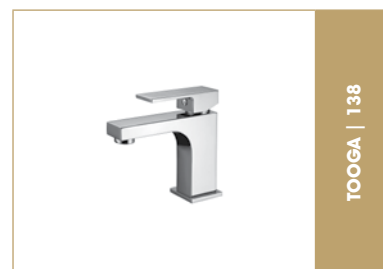
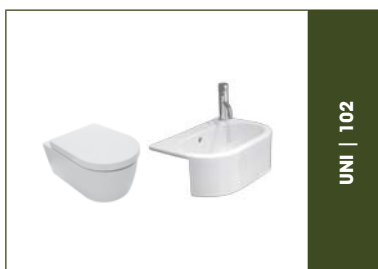
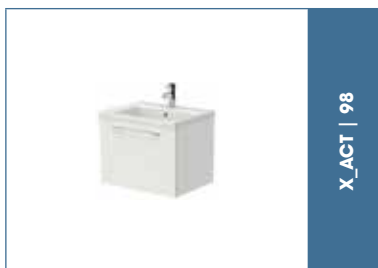
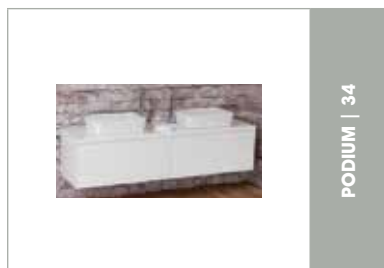
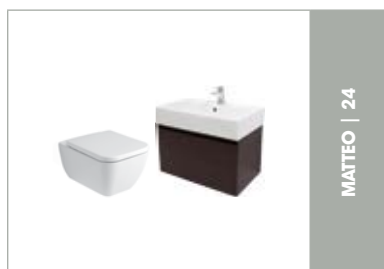



PASCALE | 152

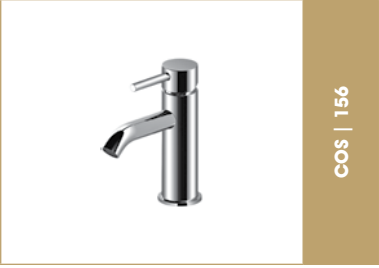

COS | 156



TEMPUS | 162



EASY O | 166



INSIDE | 168

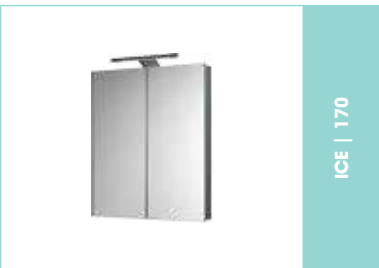

ICE | 170



ELUMINATE | 175



AGUA MAISON | 177

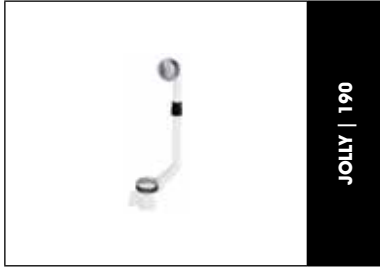

JOLLY | 190



SHOWER ENCLOSURES | 192

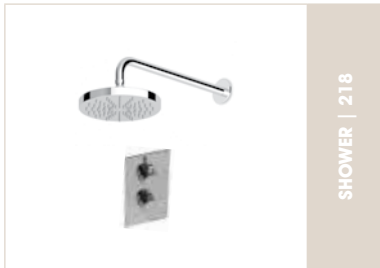

SHOWER | 218

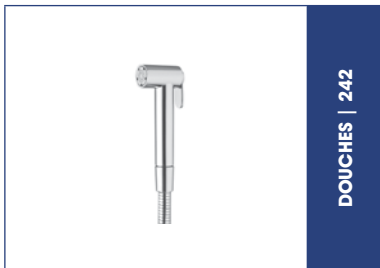

DOUCHES | 242



TEMPUS HEATED TOWEL RAILS | 245



TEMPUS ELEC TOWEL RAILS | 251



BOTTLE TRAPS & BASIN WASTES | 255



ACCESSORIES | 258

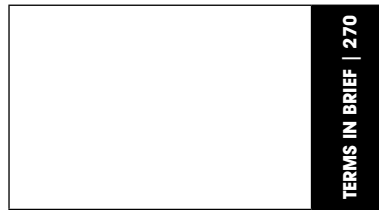

TERMS IN BRIEF | 270



CONTACT US | 274

saneux

the space you love

Welcome to Saneux luxury bathroom furniture and accessories. We are proud to create remarkable spaces dedicated to relaxation, comfort and washing. Specialising in providing the best products and services for large housing complexes, hotels, airports and luxury homes, we design our specifications around your personal needs and demands.

Our products are readily available from stock in the UK, from renowned bathroom showrooms and plumbing retailers.



Bienvenue chez Saneux, une entreprise spécialisée dans la fabrication d'accessoires et de mobilier de salle de bains de luxe. Nous sommes fiers de concevoir des espaces remarquables dédiés à la relaxation, au confort et au bien-être. Spécialisés dans la fourniture des meilleurs produits et services à destination des grands complexes résidentiels, hôtels, aéroports et maisons de luxe, nous adaptons chaque cahier des charges à vos demandes et besoins personnels.

Nos produits sont immédiatement disponibles sur stock au Royaume-Uni, auprès de distributeurs en plomberie et de vendeurs de salles de bains de renom.



QUALITY

Made from premium raw materials, our bathroom products promise quality and longevity.

As an eco-conscious company we make sure that our factories are dedicated to recycling a large percentage of our production waste. In this way we manage to reduce costs for you and the environment!

QUALITÉ

Fabriqués à partir de matières premières de haute qualité, nos produits allient qualité et longévité.

En tant qu'entreprise soucieuse de l'environnement, nous veillons à ce que nos usines recyclent une partie importante des déchets de production. Nous parvenons ainsi à réduire les coûts, à la fois pour vous et pour l'environnement !



The WOW! factor

Naturally we have a lot to WOW! about so where you see the WOW! these are some of the clever and quite ingenious features which are designed to make your bathroom that little bit more special.

So don't miss the WOW! in your bathroom

Le facteur « WOW ! »

Il y a naturellement de quoi dire « WOW ! ». Cette expression, qui apparaît sur certaines pages du présent catalogue, est là pour mettre en avant un produit ou une gamme de produits dont les caractéristiques astucieuses ont pour objectif de rendre votre salle de bains un peu plus spéciale.

Ne ratez pas l'effet « WOW ! » dans votre salle de bains.



Pictured: PODIUM 75cm unit with *ICON (available 2017) basin and TEMPUS TE430 wall-mounted mixer. Also featured, ZAHA free-standing bath.

DESIGN SOLUTIONS

Saneux bathroom furniture and accessory ranges are inspired by the natural coalition of stone and water. Using the finest materials and contemporary designs we manage to create sanitaryware that can enhance even the most complex and unusual of spaces.

We are delighted to present you with our latest product collections that promise to captivate and inspire you.

SOLUTIONS DE CONCEPTION SOLUTIONS

Les gammes d'accessoires et de mobilier de salle de bains Saneux s'inspirent du mariage naturel de la pierre et de l'eau. L'utilisation de designs contemporains et des matériaux les plus raffinés qui soient nous permet de concevoir des appareils sanitaires capables de mettre en valeur les espaces les plus complexes et les plus inhabituels.

Nous avons le plaisir de vous présenter nos toutes dernières gammes de produits, qui promettent de vous envoûter et de vous inspirer.



Pictured: X_ACT 60cm washbasin with Austen 500203 alaska 1drawer unit. Also featured PA001 washbasin monoblock mixer.



Our products are designed to have a practical use and to make your lifestyle more convenient. Whilst they provide space for organization and functionality, when it comes to Saneux bathroom furniture, you will never have to compromise on style.

ESSENTIAL STORAGE . . .

Say goodbye to cluttered drawers...

Most of our drawer furniture are simply divided using our ingenious compartments that can easily be modified to suit your family's needs.

WOW!

Dites adieu aux tiroirs encombrés...

La plupart de nos tiroirs sont divisés en compartiments simples et astucieux qu'il est possible de modifier facilement en fonction des besoins de votre famille.

WOW!

UN COMPAGNON DE RANGEMENT INDISPENSABLE...

Nos gammes sophistiquées vous offrent des solutions faciles à utiliser et à entretenir. Nos gammes de tiroirs et de meubles vous proposent un large éventail d'options qui vous permettent de personnaliser les produits en fonction de l'espace dont vous disposez et du style recherché.

Nos produits ont été conçus pour être pratiques et vous faciliter la vie. Le mobilier de salle de bains Saneux offre espace de rangement et fonctionnalité, sans aucun compromis sur le style.

Pictured: A brilliantly practical range, all under basin drawer cabinets have storage which can be divided using the drawer divider sets.

Des vasques plus profondes et améliorées...

Toutes nos gammes sont composées de vasques très profondes spécialement conçues pour celles et ceux qui souhaitent éviter au maximum les éclaboussures.

WOW!

Deeper and better..

All of our current ranges feature specially selected extra deep basins for those that seek to have minimum splash.

WOW!



Pictured: X_ACT 60cm washbasin with Austen 500203 alaska 1drawer unit. Also featured PA001 washbasin monoblock mixer.

SMOOTH SMOOTH CERAMIC . . .

Vitreous china, better known as ceramic, is a beautiful, impervious, shiny, durable surface which maintains its beauty for many years despite constant use. It dates back to ancient Egypt where their crudely-formed rough washbowls, pitchers and toilet bowls (ahem) were cutting edge technology and leaders in world design (strange but true).

Over the many centuries the manufacturing of ceramic has been perfected until now a machine knocks out more than 200 WCs per day. And with 5% tolerance - it's an artform.

Here at Saneux, we produce ceramics and furniture for your bathroom which clean beautifully, sparkle effortlessly and . . . we have introduced the joy of minimalism into the bathrooms of millions, establishing us as a market leader.

OH ! LISSE ET DOUCE CÉRAMIQUE...

La porcelaine vitrifiée, plus connue sous le nom de céramique, est une surface élégante, imperméable, brillante et durable qui, malgré l'épreuve du temps, conserve toute sa beauté pendant de nombreuses années. Ce matériau date de l'Égypte antique. Aussi surprenant que cela puisse paraître, cette civilisation était un leader mondial dans la conception de vasques, pichets et cuvettes de toilettes ; des objets grossièrement façonnés et à la pointe de la technologie.

La fabrication de cuvettes WC en céramique a évolué et s'est améliorée au fil des siècles. Aujourd'hui, une machine est capable d'en produire plus de 200 par jour, et ce, avec une tolérance de 5 %. À ce niveau, il n'est pas exagéré de parler d'art !

Chez Saneux, nous fabriquons du mobilier et des cuvettes WC en céramique qui se nettoient merveilleusement bien et brillent sans effort. En outre, . . . nous avons su insuffler un doux vent de minimalisme dans les salles de bains de millions de personnes et ainsi nous positionner comme l'un des leaders du marché.

ENVIRONMENT we care . . .

Population and climate changes, coupled with modernised lifestyles have put an increased demand on water supplies.

There are three points we need to find solutions for:

- Government legislation
- Environmental consciousness
- Saving money

Water is a right, wasting is a crime!

With the will to preserve one of the most precious resources one has . . .
We transformed two years ago from 9 litres to 6 litres as expected by ECO standards. With further intense research, we present many of our toilets having passed rigorous tests flushing only 4.5 litres of water. WOW!

Look out for our super eco toilets
wherever you see this sign



L'ENVIRONNEMENT COMME RAISON D'ÊTRE...

Les changements démographiques et climatiques, associés aux modes de vie moderne, ont entraîné une hausse de la demande en eau.

Nous nous devons de trouver des solutions en ce qui concerne :

- les textes législatifs ;
- la conscience environnementale ;
- les économies d'argent

L'eau est un droit, son gaspillage est un crime !

Soucieux de préserver l'une de nos ressources les plus précieuses . . . et conformément aux normes écologiques, nous avons réduit il y a deux ans le volume consommé par chasse d'eau, et ce, de 9 à 6 litres. Grâce à d'intenses recherches, nombre de nos cuvettes WC ne consomment que 4,5 litres d'eau par chasse d'eau. Ces cuvettes ont d'ailleurs passé avec succès différents tests rigoureux. WOW !

Découvrez nos cuvettes WC super écologiques,
matérialisées par ce symbole.





Pictured: MATTEO close-coupled WC with soft-close seat.

CONTRACTS SUPPORT



Saneux emphasizes on the importance of solid partnerships with Designers, Architects and Builders that are an essential part of our work. We have formed a specialist department that focuses entirely on the ever-growing building and commercial sector. Our DAB Team is exclusively dedicated to building new collaborations and nurturing existing relationships with our valued contracts as well as ensuring our clients receive a consistently high level of service.

At Saneux, we create the right atmosphere required to work together with Designers and to help them in their task to create exceptional homes. Apart from helping out in the selection process, designers are welcome to give us their plans on any stage of construction and we are equipped to also help stylistically with new product ranges as well as providing them with high quality CG renders of their installations.

However, our job doesn't end there. Our team is keen to assist Architects with the intricate and lengthy undertaking of product specification. We act as trusted advisors providing organized instruction and use our expertise to enable them achieve the desired results. We also built a dedicated support portal for troubleshooting and instructions and our Technical & Spares Department is always happy to provide long-term support for projects of any scale.

We always follow through our projects, from the design stages to the product selection process as well as the building stage. Working closely with Quantity Surveyors, we suggest alternatives to existing specifications, offering advice and recommendations on technical issues such as space saving and maintenance. It is our responsibility and interest to make certain that the projects are maintained in exceptional standards and therefore perform inspection visits for the purposes of project evaluation and support, years after completion.

Saneux souligne l'importance d'établir des collaborations fortes avec les designers, les architectes et les constructeurs, qui constituent des éléments essentiels de notre travail. Nous avons mis en place un département dédié entièrement tourné vers les secteurs commercial et du bâtiment, en croissance constante. Notre équipe de designers, architectes et constructeurs a pour mission d'établir de nouvelles relations, d'entretenir les relations existantes et de s'assurer que nos clients sont satisfaits à tous les niveaux.

Chez Saneux, nous créons un environnement propice à une collaboration avec les designers, afin de leur permettre de réaliser des espaces remarquables. Outre le fait de participer au processus de sélection des produits, les designers peuvent nous transmettre leurs plans à n'importe quelle étape de la construction. Nous sommes capables d'offrir une aide sur le plan stylistique grâce à des gammes innovantes et de leur fournir un rendu numérique haute qualité de leurs installations.

Toutefois, notre travail ne s'arrête pas là. Notre équipe est soucieuse d'aider les architectes dans la réalisation du cahier des charges, une tâche complexe et chronophage. Nous agissons à titre de conseillers de confiance en leur fournissant des instructions détaillées. En outre, nous nous appuyons sur notre expérience pour les aider à obtenir les résultats escomptés. Nous disposons également d'un portail de support dédié destiné à la résolution des problèmes et aux instructions. De plus, notre département technique et de pièces de rechange est toujours soucieux de fournir un soutien à long terme, et ce, dans le cadre de projets de toute taille.

Nous effectuons toujours un suivi complet de nos projets, et ce, de la conception au processus de sélection des produits, en passant par la phase de construction. En étroite collaboration avec des économistes en construction, nous proposons des alternatives aux cahiers des charges existants, fournissant ainsi des conseils et des recommandations quant aux problèmes techniques tels que l'économie d'espace et la maintenance. Il est de notre responsabilité de nous assurer que les résultats obtenus sont les meilleurs possible. C'est la raison pour laquelle nous réalisons des visites de contrôle dans le cadre de l'évaluation et de l'appui aux projets, et ce, plusieurs années après leur achèvement.



CASE STUDIES

ST. JAMES'S PLACE

This is a central London apartment refurbished by W9design in 2014. Its magnificent views of Green Park and large living spaces make this apartment a unique property in the UK market.

However, the 25 years of no refurbishment had taken its toll on the property. A fresh and contemporary interior treatment breathed new life into its generous living spaces. Within the timeframe of only 6 months, W9design managed to refurbish the entire property, including installation of new electrics, plumbing, flooring, decorating and furnishings. By incorporating some 1970's vintage pieces to the otherwise restrained style of the refurbished flat, W9design added character and unique charm.

This two storey property boasts 4 bedrooms, a large living room and reception, a kitchen with dining area and a study. The renovation also included a new cloakroom and three new bathrooms. W9design used several items from our beloved MATTEO collection to create bathrooms that accommodate the needs of the occupier and that match the unparalleled design standards of the rest of the property.



Rénové par W9design en 2014, cet appartement se situe en plein cœur de Londres. Les vues incroyables sur Green Park et les grandes pièces à vivre font de cet appartement un bien immobilier unique sur le marché britannique.

Toutefois, l'absence de travaux de remise en état pendant 25 ans n'a pas été des plus bénéfiques pour cet appartement. Des travaux de rénovation contemporains ont ainsi permis de donner un nouveau souffle aux vastes espaces de vie. En seulement 6 mois, W9design est parvenu à rénover l'ensemble de l'appartement, y compris les installations électriques, la plomberie, les sols, la décoration et le mobilier. En associant le caractère vintage de certains objets des années 1970 au style sobre de l'appartement rénové, W9design a su lui conférer un charme unique et lui redonner du caractère.

Cet appartement sur deux étages comprend 4 chambres, un grand séjour, une cuisine avec coin repas et un bureau. Un cabinet de toilette et trois salles de bains ont également été aménagés. W9design a utilisé divers produits de notre gamme MATTEO pour concevoir des salles de bains qui répondent aux besoins de l'utilisateur et correspondent aux normes de conception uniques du reste de l'appartement.



HOVE PARK VILLA

The Hove Park Villa residential project was completed by CDMS Architects and has won the Sussex Heritage Trust Award 2010, Residential Award. The refurbishment of this period style home, first built in the early 1900's, was assigned and carried out in two stages.

The first phase of the renovation included works to the main bedrooms, bathrooms and living spaces while the second phase involved the redesigning of the kitchen and utility areas and full landscaping to the garden. The procedure included the demolition of the garage and the construction of an extension to the kitchen as well as modifications to the original layout. Using quality materials and finishes has created a better sense of connection and flow throughout the property while still maintaining the character and appeal of this Edwardian home.

CDMS Architects, once again chose to use Saneux sanitaryware to ensure that the high standard of the renovation was achieved throughout the bathroom areas as well. Selecting our QUADRO basins and JONES back-to-wall pan, they managed to create bathroom spaces that are both stylish and functional.

Réalisé par la société CDMS Architects, le projet résidentiel Hove Park Villa s'est vu décerner le prix « Residential Award 2010 » par l'association Sussex Heritage Trust. La rénovation de cette maison d'époque, construite au début du 20e siècle, s'est déroulée en deux étapes.

Les travaux de la première phase concernaient les chambres principales, les salles de bains et les pièces à vivre, tandis que la seconde phase visait notamment à repenser la cuisine et à aménager le jardin. Ainsi, le garage a été détruit, tandis que la cuisine a été agrandie et repensée. L'utilisation de matériaux et de finitions de qualité a permis de garantir une meilleure continuité entre les pièces, tout en conservant le caractère et le charme de cette maison de style édouardien.

CDMS Architects a fait le choix des appareils sanitaires Saneux, et ce, dans l'objectif de respecter également un très haut niveau d'exigence au sein des salles de bains. Le fait d'opter pour nos vasques QUADRO et nos cuvettes classiques JONES a permis à cette société de concevoir des espaces à la fois élégants et fonctionnels.



Case Studies

FIELDING ROAD

The Fielding Road project is a residential property located in West London. This Victorian terrace house spreads into four floors and following initial architectural and extension works, interior design work remained to be done.

Diego Correa, interior designer, took over phase two which included works to the staircase area, living and reading areas as well as remodeling two bathrooms. The challenge was to maintain the Victorian details around the house whilst giving a new and sophisticated look to resonate within the house and provide the sense of continuation between the different rooms.

One of the bathrooms to be renovated was to be for the family's three children's use. The client requested for yellow to be incorporated into the design. Diego Correa managed to combine a hue of yellow with the rest of the room in a gray palette that would connect the bathroom with the other rooms and staircase space. The design is one that will last and work even when the children become teenagers.

The second bathroom was a guest bathroom. In this room, Diego opted for a soberer look yet with an informal elegance that would give it a welcoming appearance. He achieved that feel, using brown and walnut shades and matt tiles and finishes.

In both bathrooms, Diego used products from our Austen and Elluminate ranges. To view the entire Diego Correa portfolio visit their website here. Credit for the beautiful pictures goes to talented photographer Enzo Mercedes.

Le projet Fielding Road est un bien résidentiel situé à l'ouest de Londres. Cette maison mitoyenne de style victorien s'étend sur quatre étages. Une fois les travaux architecturaux et d'extension terminés, il restait encore à faire l'aménagement intérieur.

Diego Correa, architecte d'intérieur, fut chargé de la mise en œuvre de la phase deux du projet ; phase qui comprenait les travaux au niveau des escaliers et des espaces de vie et de lecture, ainsi que la rénovation des deux salles de bains. Le défi fut non seulement d'assurer une certaine continuité entre les différentes pièces, mais également de conserver les détails de l'époque victorienne tout en donnant une nouvelle apparence, plus raffinée, à l'intérieur de la maison.

L'une des salles de bains à rénover était destinée aux trois enfants de la famille. Le client souhaitait que la couleur jaune soit intégrée au design de cette salle de bains. Diego Correa est parvenu à associer une teinte de jaune avec le reste de la pièce grâce à une palette de gris, permettant ainsi de relier la salle de bains aux autres pièces et aux escaliers. Le design de cette pièce conservera son charme au fil des années, et ce, à mesure que les enfants grandissent et deviennent des adolescents.

L'autre salle de bains était destinée aux invités. Dans cette pièce d'une élégance informelle, l'architecte d'intérieur a opté pour une apparence plus sobre, mais non moins chaleureuse. Pour ce faire, il a eu recours à des nuances de marron et de noyer, ainsi qu'à des finitions et du carrelage de couleur mate.

Diego Correa s'est appuyé sur nos gammes Austen et Elluminate pour aménager ces deux salles de bains. Pour découvrir le portfolio de Diego Correa, rendez-vous sur son site Web en cliquant ici. Nous tenons à remercier le photographe Enzo Mercedes pour ces magnifiques photos.



PORTOBELLO TERRACE

The Barnes Villas are located near the river Thames providing the atmosphere and serenity of the countryside, whilst being situated only 30 minutes away from central London. Perfect for a family living but not lacking the comforts and entertainment of city life, it combines the best of both worlds.

The Portobello Terrace Project demanded sophisticated bathrooms that would correspond to the luxury standards and necessities of a stylish lifestyle. We were pleased to collaborate with Nicolas King Homes and offer consultation in the selection of Saneux sanitarywear that would implement the character of these homes.

In order to provide a different personality to each bathroom, Nicolas King Homes selected products from a variety of ranges including our MATTEO basins and units and ICE cabinets promising exceptional quality and bathroom indulgence for years to come.

Situées à proximité de la Tamise, les villas de Barnes offrent l'atmosphère et la sérénité de la campagne tout en se trouvant à 30 minutes seulement du centre de Londres. Idéales pour les familles tout en offrant le confort et les distractions de la vie en ville, ces villas combinent le meilleur des deux mondes.

Le projet Portobello Terrace exigeait des salles de bains sophistiquées qui correspondraient aux standards et besoins luxueux d'un mode de vie raffiné. Nous avons eu le plaisir de collaborer avec Nicholas King Homes et de proposer des conseils lors de la sélection d'appareils sanitaires intégrant le caractère de ces maisons.

Dans l'objectif d'offrir une personnalité différente à chaque salle de bains, le promoteur immobilier Nicholas King Homes a sélectionné des produits parmi un éventail de gammes, y compris nos lavabos et meubles MATTEO et armoires avec miroir ; la promesse d'une qualité exceptionnelle et d'un plaisir pendant plusieurs années.



Pictured: MATTEO 39003 washbasin with handleless drawer units.
Also featured, MERCURY 3-hole basin mixers and INSIDE recessed mirror cabinets.



MATTEO

. . . a refined living experience

Featuring bathroom furniture in five exciting colours and three sizes, MATTEO is designed and focused to deliver a refined bathroom experience - every day.

MATTEO . . . une expérience raffinée

Vous n'entendrez rien... puisque nous utilisons les meilleures coulisses du marché afin de nous assurer que nos tiroirs se ferment en douceur et sans aucun bruit !

Des armoires minimalistes avec fermeture en douceur, aux finitions blanc satiné, noir satiné, wengé, gris satiné et chêne doré, aux lignes épurées et disponibles dans quatre tailles différentes.

Pictured: MATTEO tall side unit in gloss white.

Matteo: a luxury collection with distinctive design and generous dimensions. Minimalist square washbasins with or without furniture.

Matteo : une gamme de luxe au design distinctif et aux dimensions généreuses. Des lavabos carrés minimalistes avec ou sans mobilier.



Now that's luxury...
 Matteo has amazing distinctive design with generous dimensions, coupled with the perfect new handleless furniture... bathrooms don't get much better than this

Ça, c'est le luxe !...
 La gamme Matteo se caractérise par son design distinctif et ses dimensions généreuses, mais également par son nouveau mobilier sans poignée. En termes de salles de bains, vous ne trouverez pas mieux.



'Matteo is perfect for larger housing projects including commercial specification because of its classic design'

Architect
 Notting Hill, London

< La gamme Matteo est la solution idéale pour les vastes projets de logements, y compris les projets commerciaux, et ce, en raison de son design classique. >

Un architecte de Notting Hill, Londres

Pictured: Matteo 39003 75 x 45cm washbasin & MG4001 white gloss drawer unit, Matteo 60155 W/M pan & 60156 bidet.



Pictured: Matteo MG8205 60 x 42cm Golden Oak 1 drawer unit. Also featured, GF0106 tall side unit and INSIDE IN001 mirror cabinet.

Le cas échéant et pour £23,08 TTC l'unité, il est possible de percer des trous supplémentaires. Veuillez indiquer le code ETH si vous souhaitez des trous supplémentaires afin d'installer des robinets. Sauf indication contraire, tous les lavabos et meubles peuvent être fixés au mur.

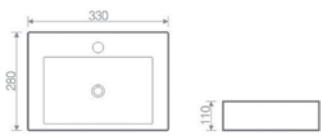

CODE
39008

DESCRIPTION
Matteo 33 x 28cm washbasin 1 tap hole

INC VAT
£91.13

TVA INC
122.11€

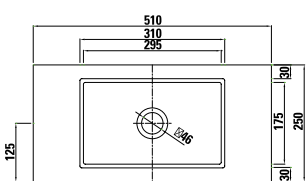

CODE
39006
39006.LH
39006.RH

DESCRIPTION
Matteo 51 x 25cm washbasin no tap hole
Matteo 51 x 25cm washbasin left hand tap hole
Matteo 51 x 25cm washbasin right hand tap hole

INC VAT
£170.75
£170.75
£170.75

TVA INC
228.80€
228.80€
228.80€

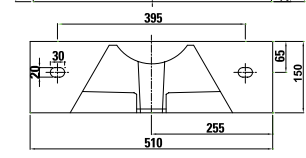

CODE
MG2501
QU25023

DESCRIPTION
2 door white gloss cabinet
2 door new wengé cabinet

INC VAT
£299.04
£299.04

TVA INC
400.72€
400.72€

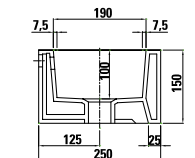

CODE
PLMQ2501

OPTIONAL EXTRA PLINTH KIT
White gloss plinth kit for MG2501

Plinth kit includes 1 front plinth, 2 side plinths, 4 leveling legs, plinth clips and fixings

INC VAT
£59.99

TVA INC
80.38€

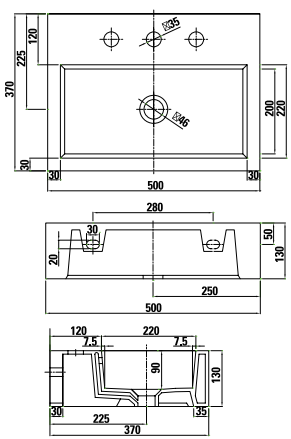
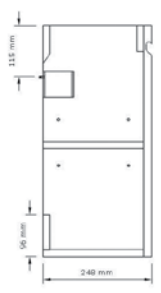
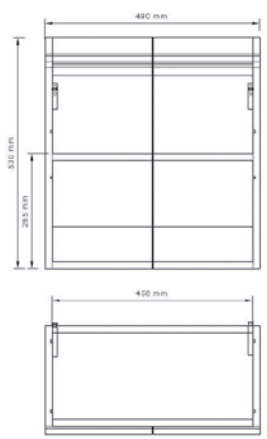

CODE
39001
39001.0

DESCRIPTION
Matteo 50 x 37cm washbasin 1 tap hole
Matteo 50 x 37cm washbasin no tap hole

INC VAT
£220.00
£220.00

TVA INC
294.79€
294.79€



CODE
MG8501
MG8502
MG8503
MG8505
MG8506

DESCRIPTION
White gloss soft close handleless drawer unit
Black gloss soft close handleless drawer unit
Wengé soft close handleless drawer unit
Grey gloss soft close handleless drawer unit
Golden oak soft close handleless drawer unit

INC VAT
£360.53
£379.85
£315.65
£379.85
£315.65

TVA INC
483.12€
508.99€
422.97€
508.99€
422.97€

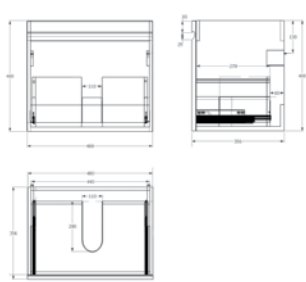

Matteo

Extra holes can be drilled where required for £23.08 inc. VAT each, please quote code ETH when ordering extra tap holes.
 All washbasins and units can be wall mounted unless specified.



CODE
39002
39002.0

DESCRIPTION
 Matteo 60 x 42cm washbasin 1 tap hole
 Matteo 60 x 42cm washbasin no tap hole

INC VAT	TVA INC
£242.28	324.66€
£242.28	324.66€

CODE
MG8201
MG8202
MG8203
MG8205
MG8206

DESCRIPTION
 White gloss soft close handleless drawer unit
 Black gloss soft close handleless drawer unit
 Wengé soft close handleless drawer unit
 Grey gloss soft close handleless drawer unit
 Golden oak soft close handleless drawer unit

INC VAT	TVA INC
£395.32	529.72€
£416.71	558.39€
£333.84	447.35€
£416.71	558.39€
£333.84	447.35€

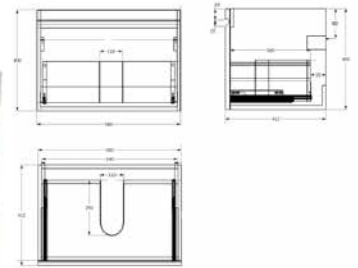
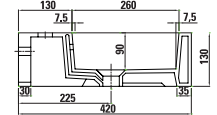
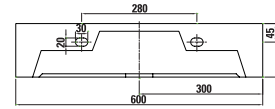
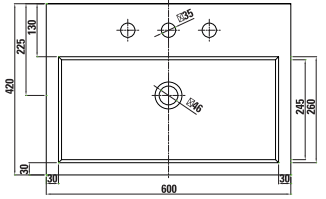

CODE
39003
39003.0

DESCRIPTION
 Matteo 75 x 45cm washbasin 1 tap hole
 Matteo 75 x 45cm washbasin no tap hole

INC VAT	TVA INC
£323.03	432.86€
£323.03	432.86€

CODE
MG4001
MG4002
MG4003

DESCRIPTION
 White gloss soft close drawer unit
 Black gloss soft close drawer unit
 Wengé soft close drawer unit

INC VAT	TVA INC
£514.15	688.96€
£514.15	688.96€
£514.15	688.96€

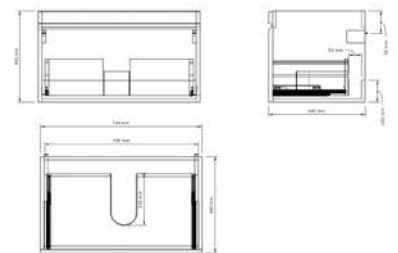
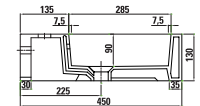
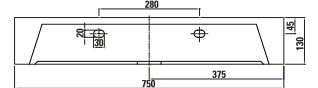
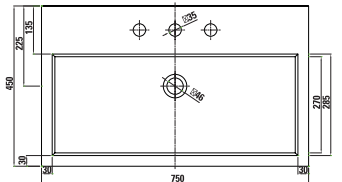

CODE	DESCRIPTION	INC VAT	TVA INC
MMG01	50 x 70cm mirrored cabinet – white gloss	£279.01	373.88€
MMG02	50 x 70cm mirrored cabinet – black gloss	£279.01	373.88€
MMG03	50 x 70cm mirrored cabinet – wengé	£279.01	373.88€
MMG05	50 x 70cm mirrored cabinet – grey gloss	£279.01	373.88€
MMG06	50 x 70cm mirrored cabinet – golden oak	£279.01	373.88€

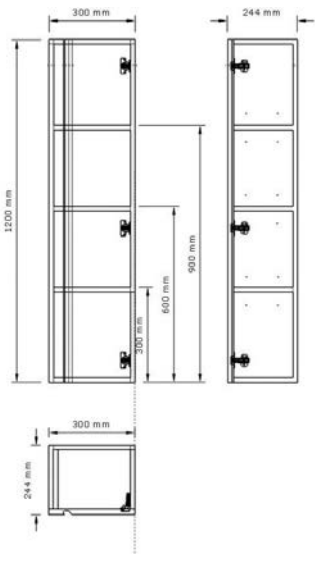

CODE	DESCRIPTION	INC VAT	TVA INC
GF0101	MATTEO soft close side unit 1200 x 300 x 240 – white gloss	£452.70	606.62€
GF0102	MATTEO soft close side unit 1200 x 300 x 240 – black gloss	£490.26	656.95€
GF0103	MATTEO soft close side unit 1200 x 300 x 240 – wengé	£375.06	502.58€
GF0105	MATTEO soft close side unit 1200 x 300 x 240 – grey gloss	£490.26	656.95€
GF0106	MATTEO soft close side unit 1200 x 300 x 240 – golden oak	£375.06	502.58€



CODE	DESCRIPTION	INC VAT	TVA INC
GF0201	MATTEO soft close side unit 400 x 400 x 160 – white gloss	£258.44	346.31€
GF0202	MATTEO soft close side unit 400 x 400 x 160 – black gloss	£276.28	370.21€
GF0203	MATTEO soft close side unit 400 x 400 x 160 – wengé	£236.17	316.46€
GF0205	MATTEO soft close side unit 400 x 400 x 160 – grey gloss	£276.28	370.21€
GF0206	MATTEO soft close side unit 400 x 400 x 160 – golden oak	£236.17	316.46€



Pictured: Matteo 60155 wall-mounted WC & Flushe FP031 white dot flush plate.



MATTEO WC'S & BIDETS

Matteo WCs & Bidets

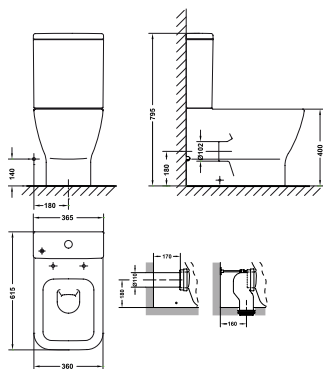

CODE
60130
60131
60133c

DESCRIPTION
 Matteo close coupled wc pan
 Matteo cistern
 Matteo soft close seat for c/c option

INC VAT **TVA INC**
 £236.83 317.36€
 £160.12 214.56€
 £149.85 200.79€

Total including soft close seat **£546.80** **732.71€**

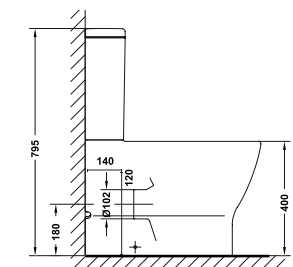

CODE
601301
60131
60133c

DESCRIPTION
 Matteo close coupled wc pan. L/H soil exit
 Matteo cistern
 Project soft close seat for c/c option

INC VAT **TVA INC**
 £306.31 410.46€
 £160.12 214.56€
 £149.85 200.79€

Total including soft close seat **£616.28** **825.81€**

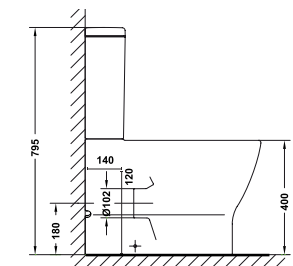

CODE
601302
60131
60133c

DESCRIPTION
 Matteo close coupled wc pan. R/H soil exit
 Matteo cistern
 Matteo soft close seat for c/c option

INC VAT **TVA INC**
 £306.31 410.46€
 £160.12 214.56€
 £149.85 200.79€

Total including soft close seat **£616.28** **825.81€**

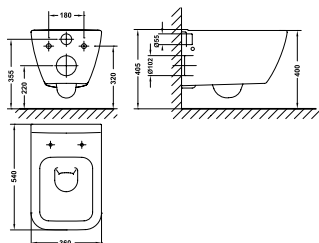

CODE
60155
60133w

DESCRIPTION
 Matteo wc pan – wall hung
 Matteo soft close seat for w/h option

INC VAT **TVA INC**
 £377.75 506.19€
 £149.85 200.79€

Total including pan and soft close seat **£527.60** **706.98€**

Available cisterns p.128

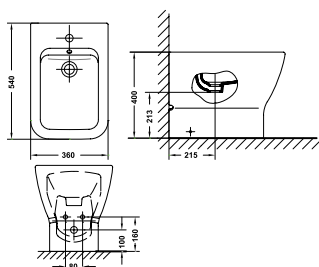

CODE
60140
60141

DESCRIPTION
 Matteo bidet
 Matteo bidet cover

INC VAT **TVA INC**
 £240.99 322.92€
 £115.07 154.20€

Total including cover **£356.06** **477.12€**

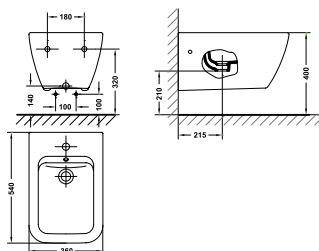

CODE
60156
60141

DESCRIPTION
 Matteo bidet – wall hung
 Matteo bidet cover

INC VAT **TVA INC**
 £339.16 454.48€
 £115.07 154.20€

Total including cover **£454.23** **608.68€**



CODE
60133c
60133w

DESCRIPTION
 Matteo soft close seat for c/c option
 Matteo soft close seat for w/h option

NC VAT **TVA INC**
 £149.85 200.79€
 £149.85 200.79€



PODIUM

PODIUM



A tradition
in trend...

Pictured: Podium M0201.1 handleless unit with *ICON (available 2017) sit-on bowl. Also featured, INSIDE IN001 recessed mirror cabinet and PRAGUE close-coupled WC.



*'I've been bitten by the saneux bug and
I've only done one project'*

Architect
London, EC1

« Je n'ai réalisé qu'un seul projet et pourtant, j'ai déjà le virus Saneux. »

Un architecte de Londres, EC1

Podium

For the ultimate minimalist look

Extra holes can be drilled where required for £23.08 inc. VAT each, please quote code ETH when ordering extra tap holes.
All washbasins and units can be wall mounted unless specified.



CODE
39008

DESCRIPTION
Matteo 33 x 28cm washbasin 1 tap hole

INC VAT
£91.13

TVA INC
122.11€

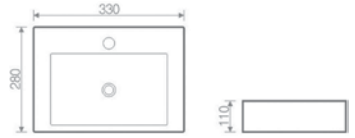

CODE

39006

DESCRIPTION
Matteo 51 x 25cm washbasin no tap hole

INC VAT

£170.75

TVA INC

228.80€

39006.LH

Matteo 51 x 25cm washbasin left hand tap hole

£170.75

228.80€

39006.RH

Matteo 51 x 25cm washbasin right hand tap hole

£170.75

228.80€

CODE

M0601.1

DESCRIPTION
Podium 1 door white gloss unit

INC VAT

£365.54

TVA INC

489.83€

M0603.1

Podium 1 door zulu wengé unit

£365.54

489.83€

CODE

PLM0601

OPTIONAL EXTRA PLINTH KIT

Podium Gloss white plinth kit

INC VAT

£69.22

TVA INC

92.75€

PLM0603

Podium Zulu wengé plinth kit

£69.22

92.75€

Plinth kit includes 1 front plinth, 2 side plinths,
4 leveling legs, plinth clips and fixings

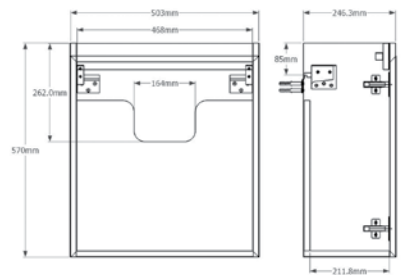
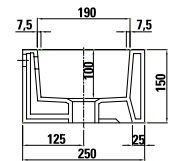
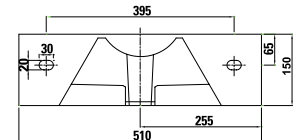
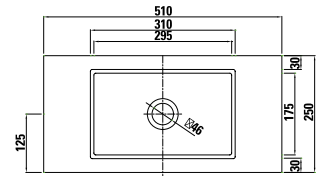

The PODIUM range of handleless furniture is the ultimate statement of style, quality and minimalism.

The furniture gets coated with 5 layers of lacquer and undergoes strict QC. The drawers are fitted with premium runners and hinges.

It's all in the detail..

La gamme PODIUM de mobilier sans poignée est l'ultime symbole du style, de la qualité et du minimalisme.

Le mobilier est recouvert de 5 couches de laque et soumis à un contrôle qualité rigoureux. Les tiroirs sont dotés de coulisses et de charnières de haute qualité.

Tout est dans le détail !

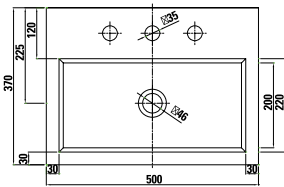

CODE
39001
39001.0

DESCRIPTION
Matteo 50 x 37cm washbasin 1 tap hole
Matteo 50 x 37cm washbasin no tap hole

INC VAT **TVA INC**
£220.00 270.49€
£220.00 270.49€

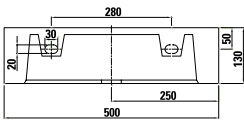

CODE
M0101.1
M0103.1

DESCRIPTION
Podium 1 drawer white gloss unit
Podium 1 drawer zulu wengé unit

INC VAT **TVA INC**
£503.38 674.53€
£503.38 674.53€

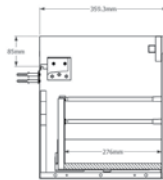
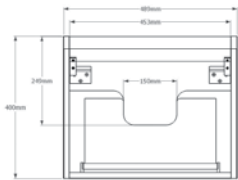
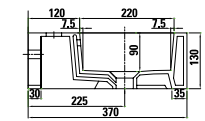

CODE
M0101.2
M0103.2

DESCRIPTION
Podium 2 drawer white gloss unit
Podium 2 drawer zulu wengé unit

INC VAT **TVA INC**
£755.05 1011.77€
£755.05 1011.77€

CODE
PLM0101
PLM0103

OPTIONAL EXTRA PLINTH KIT FOR DOUBLE DRAWER UNIT
Podium Gloss white plinth kit for double drawer unit
Podium Zulu wengé plinth kit for double drawer unit

INC VAT **TVA INC**
£71.53 95.86€
£71.53 95.86€

Plinth kit includes 1 front plinth, 2 side plinths, 4 leveling legs, plinth clips and fixings

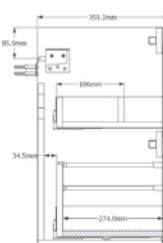
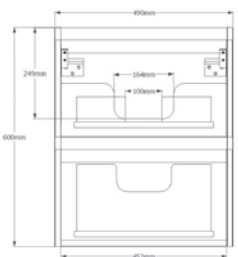

Podium

For the ultimate minimalist look

Extra holes can be drilled where required for £23.08 inc. VAT each, please quote code ETH when ordering extra tap holes.
All washbasins and units can be wall mounted unless specified.



CODE
39002
39002.0

DESCRIPTION
Matteo 60 x 42cm washbasin 1 tap hole
Matteo 60 x 42cm washbasin no tap hole

INC VAT	TVA INC
£242.28	324.66€
£242.28	324.66€

CODE
M0201.1
M0203.1

DESCRIPTION
Podium 1 drawer white gloss unit
Podium 1 drawer zulu wengé unit

INC VAT	TVA INC
£519.08	695.57€
£519.08	695.57€

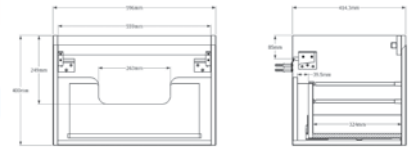
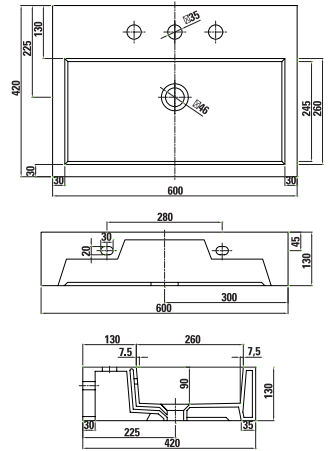

CODE
M0201.2
M0203.2

DESCRIPTION
Podium 2 drawer white gloss unit
Podium 2 drawer zulu wengé unit

INC VAT	TVA INC
£761.06	1019.82€
£761.06	1019.82€

CODE
PLM0201
PLM0203

OPTIONAL EXTRA PLINTH KIT FOR DOUBLE DRAWER UNIT
Podium White gloss plinth kit for double drawer unit
Podium Zulu wengé plinth kit for double drawer unit

INC VAT	TVA INC
£71.53	95.86€
£71.53	95.86€

Plinth kit includes 1 front plinth, 2 side plinths,
4 leveling legs, plinth clips and fixings

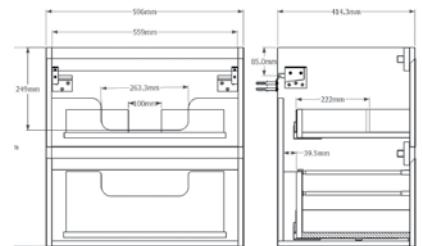



Pictured: PODIUM M0201.1 gloss white handleless unit with matching MATTEO 39002 basin and TOOGA T0002 basin mixer monoblock.

Podium

For the ultimate minimalist look

Extra holes can be drilled where required for £23.08 inc. VAT each, please quote code ETH when ordering extra tap holes.
 All washbasins and units can be wall mounted unless specified.

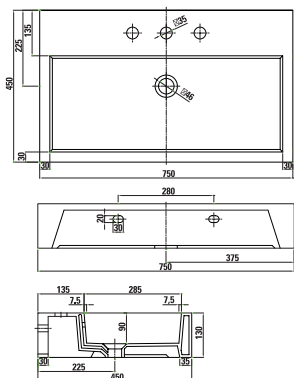

CODE
39003
39003.0

DESCRIPTION
 Matteo 75 x 45cm washbasin 1 tap hole
 Matteo 75 x 45cm washbasin no tap hole

INC VAT	TVA INC
£323.03	432.86€
£323.03	432.86€



CODE
M0301.1
M0303.1

DESCRIPTION
 Podium 1 drawer white gloss unit
 Podium 1 drawer zulu wengé unit

INC VAT	TVA INC
£611.24	819.06€
£611.24	819.06€



CODE
M0301.2
M0303.2

DESCRIPTION
 Podium 2 drawer white gloss unit
 Podium 2 drawer zulu wengé unit

INC VAT	TVA INC
£832.96	1116.17€
£832.96	1116.17€

CODE
PLM0301
PLM0303

OPTIONAL EXTRA PLINTH KIT FOR DOUBLE DRAWER UNIT
 Podium White gloss plinth kit for double drawer unit
 Podium Zulu wengé plinth kit for double drawer unit

INC VAT	TVA INC
£77.29	103.57€
£77.29	103.57€

Plinth kit includes 1 front plinth, 2 side plinths,
 4 leveling legs, plinth clips and fixings

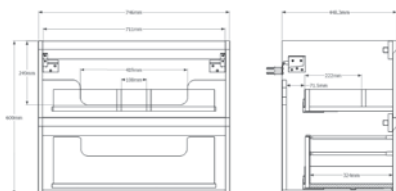

Pictured: PODIUM M0203.1 gloss white handleless unit with matching MATTEO 39003 basin.
Also featured, COS C0001 basin mixer monoblock.

PODIUM



Podium configurations

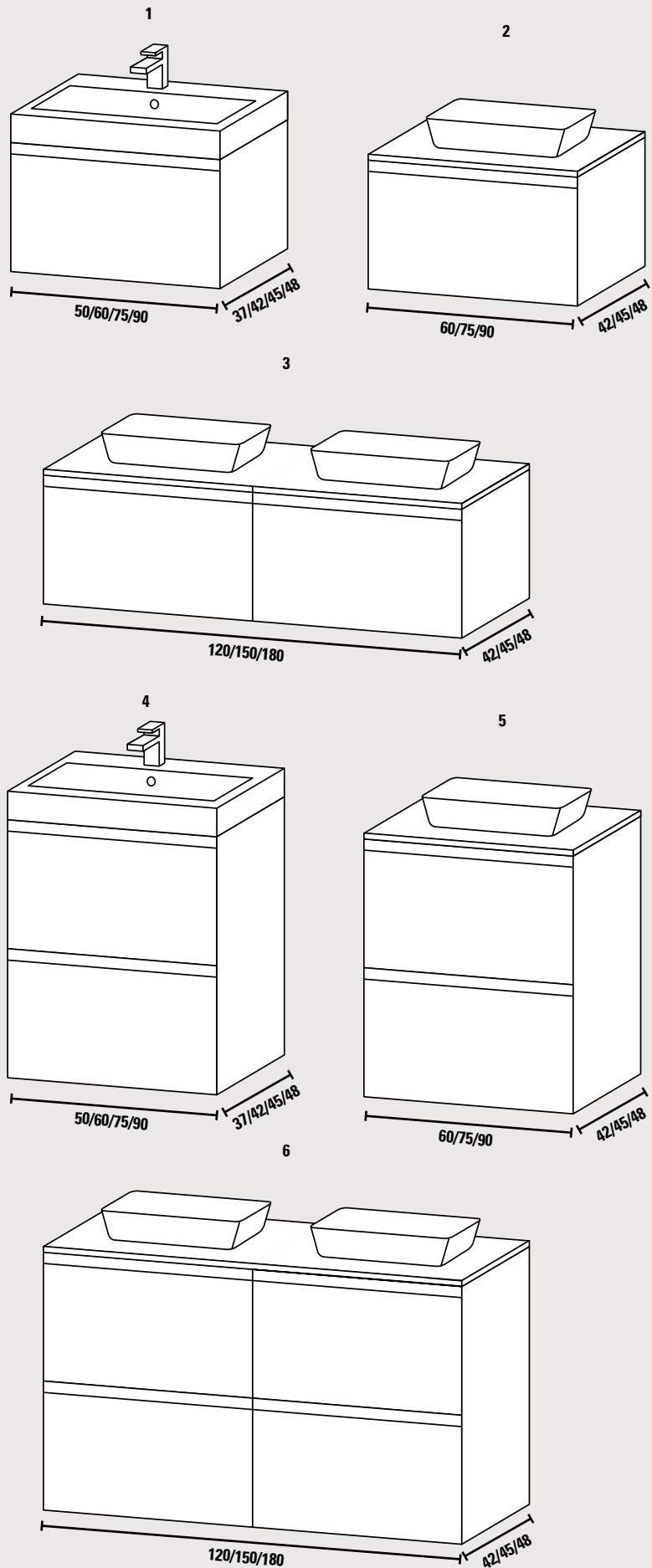

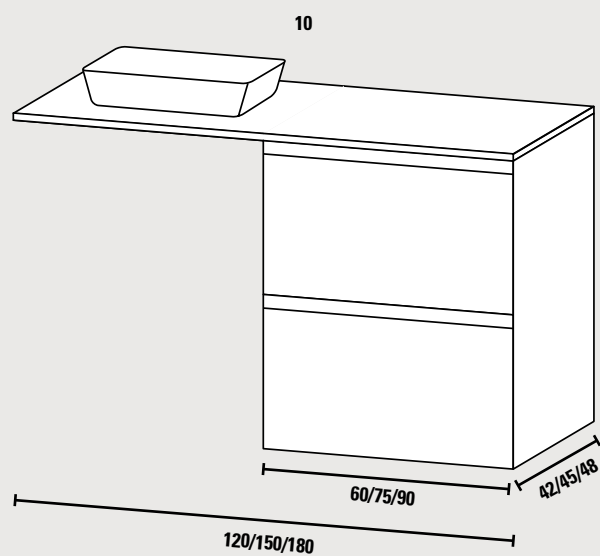
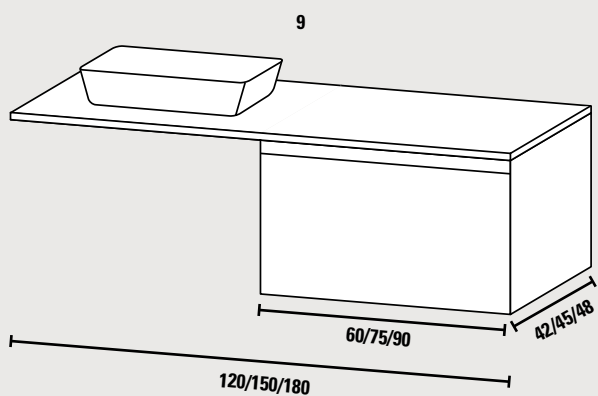
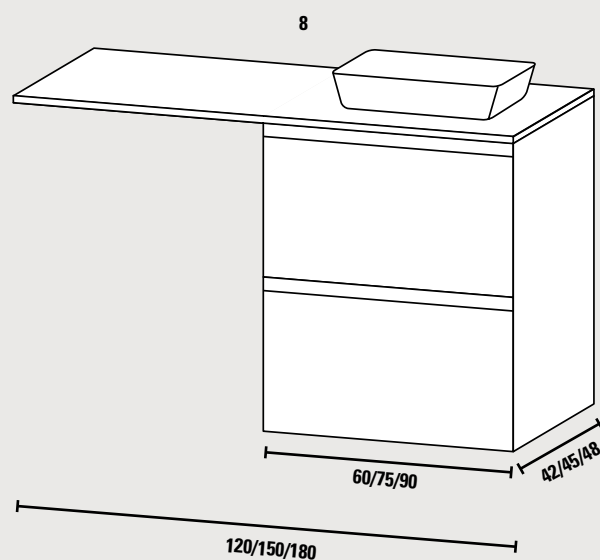
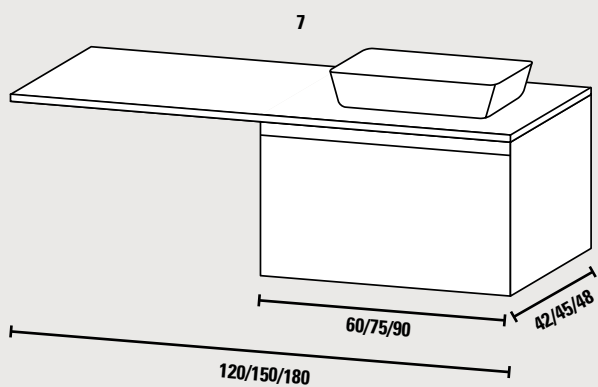

1	1 x 1 drawer unit & 1 x basin
2	1 x 1 drawer unit, 1 x countertop & 1 x sit on basin
3	2 x drawer unit, 1 x countertop & 2 x sit on bowl
4	1 x 2 drawer unit & 1 x basin
5	1 x 2 drawer unit, 1 x countertop & 1 x sit on bowl
6	2 x 2 drawer unit, 1 x countertop & 2 x sit on bowl
7	1 x 1 drawer unit, 1 x countertop & 1 x sit on bowl
8	1 x 2 drawer unit, 1 x countertop & 1 x sit on bowl
9	1 x 1 drawer unit, 1 x countertop & 1 x sit on bowl
10	1 x 2 drawer unit, 1 x countertop & 1 x sit on bowl

Podium

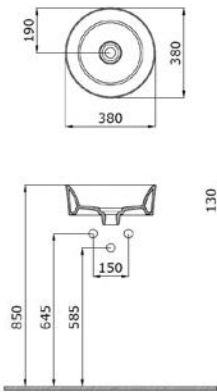

CODE	DESCRIPTION	INC VAT	TVA INC
39020	PODIUM round cloakroom washbasin 380mm – White - no overflow	£293.75	396.63€
39021	PODIUM round cloakroom washbasin 380mm – Matt Black - no overflow	£293.75	396.63€
39022	PODIUM round cloakroom washbasin 380mm – Matt Grey - no overflow	£293.75	396.63€
39023	PODIUM round cloakroom washbasin 380mm – Matt Cashmere - no overflow	£293.75	396.63€

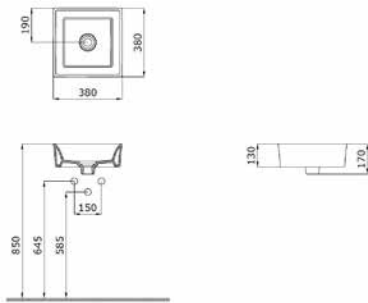

CODE	DESCRIPTION	INC VAT	TVA INC
39030	PODIUM square cloakroom washbasin 380 x 380mm – White - no overflow	£293.75	396.63€
39031	PODIUM square cloakroom washbasin 380 x 380mm – Matt Black - no overflow	£293.75	396.63€
39032	PODIUM square cloakroom washbasin 380 x 380mm – Matt Grey - no overflow	£293.75	396.63€
39033	PODIUM square cloakroom washbasin 380 x 380mm – Matt Cashmere - no overflow	£293.75	396.63€

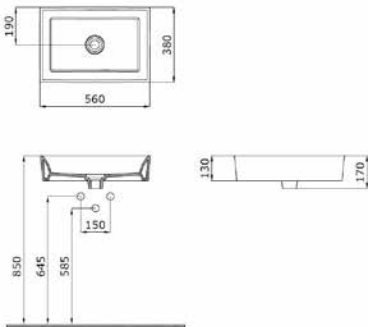

CODE	DESCRIPTION	INC VAT	TVA INC
39040	PODIUM square sit-on washbasin 550 x 380mm – White - no overflow	£293.75	396.63€
39041	PODIUM square sit-on washbasin 550 x 380mm – Matt Black - no overflow	£293.75	396.63€
39042	PODIUM square sit-on washbasin 550 x 380mm – Matt Grey - no overflow	£293.75	396.63€
39043	PODIUM square sit-on washbasin 550 x 380mm – Matt Cashmere - no overflow	£293.75	396.63€

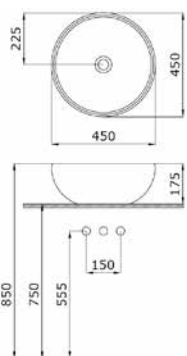

CODE	DESCRIPTION	INC VAT	TVA INC
39050	PODIUM round sit-on washbasin 450mm – White - no overflow	£293.75	396.63€
39051	PODIUM round sit-on washbasin 450mm – Matt Black - no overflow	£293.75	396.63€
39052	PODIUM round sit-on washbasin 450mm – Matt Grey - no overflow	£293.75	396.63€
39053	PODIUM round sit-on washbasin 450mm – Matt Cashmere - no overflow	£293.75	396.63€





Pictured: Podium 39040 square sit on washbasin 550 x 380 in white.
Also featured, Nicholson NI104 tall washbasin monoblock.

Podium



CODE
50018

DESCRIPTION
Austen round sit on bowl 32cm
No overflow

INC VAT £134.00
TVA INC 179.56€

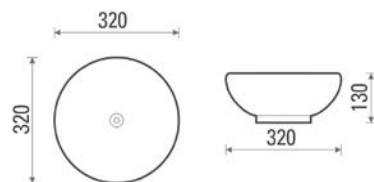

CODE
39007

DESCRIPTION
Matteo countertop washbasin 48 x 37cm
No overflow

INC VAT £137.93
TVA INC 184.82€

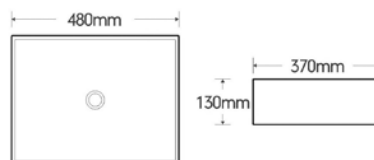

CODE
39009

DESCRIPTION
Podium sit on bowl 48 x 35cm
No overflow

INC VAT £122.00
TVA INC 163.48€

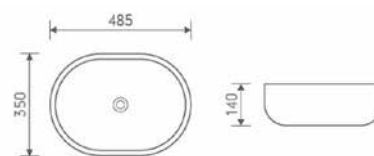

CODE
39010

DESCRIPTION
Podium sit on bowl 56 x 35cm

INC VAT £116.70
TVA INC 156.38€

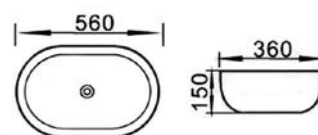

CODE
39011

DESCRIPTION
Podium sit on bowl 42 x 32cm
No overflow

INC VAT £116.69
TVA INC 156.37€

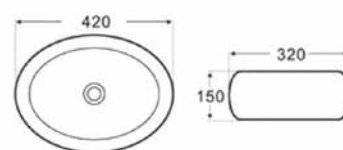

CODE
39012

DESCRIPTION
Podium sit on bowl 41 x 34cm
No overflow

INC VAT £111.39
TVA INC 149.27€

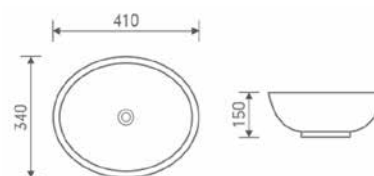

CODE
6682

DESCRIPTION
Podium 60 x 42cm sit-on washbasin
with overflow

INC VAT £265.22
TVA INC 355.40€

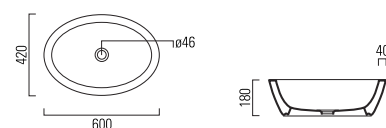

500mm Countertop

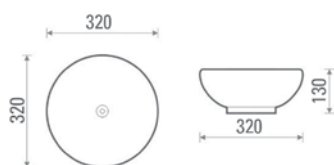

QTY	CODE	DESCRIPTION	INC VAT	TVA INC
x1	50018	Austen round sit on bowl 32cm	£134.00	179.56€
x1	MC50.01	Podium White gloss countertop, 500 x 370mm	£186.96	250.53€
x1	MC50.03	Podium Zulu wengé countertop, 500 x 370mm	£160.50	215.07€
x1	M0101.1	Podium 1 drawer white gloss unit	£503.38	674.53€
x1	M0103.1	Podium 1 drawer zulu wengé unit	£503.38	674.53€
Total (WHITE countertop, unit & basin)			£824.34	1104.62€
Total (ZULU WENGÉ countertop, unit & basin)			£797.88	1069.16€



Double-height drawer units are also available for this configuration from the Podium range.
La gamme Podium de mobilier sans poignée propose également des tiroirs double hauteur pour cette configuration.

600mm Countertop

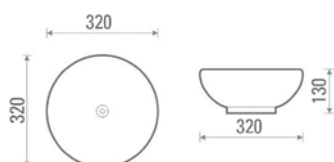

QTY	CODE	DESCRIPTION	INC VAT	TVA INC
x1	50018	Austen round sit on bowl 32cm	£134.00	179.56€
x1	MC60.01	Podium White gloss countertop, 600 x 420mm	£203.75	273.02€
x1	MC60.03	Podium Zulu wengé countertop, 600 x 420mm	£177.38	237.68€
x1	M0201.1	Podium White gloss drawer unit, 600 x 420mm	£519.08	695.57€
x1	M0203.1	Podium Zulu wengé drawer unit, 600 x 420mm	£519.08	695.57€
Total (WHITE countertop, unit & basin)			£856.83	1148.15€
Total (ZULU WENGÉ countertop, unit & basin)			£830.46	1112.81€



Double-height drawer units are also available for this configuration from the Podium range.
La gamme Podium de mobilier sans poignée propose également des tiroirs double hauteur pour cette configuration.

750mm Countertop



QTY	CODE	DESCRIPTION	INC VAT	TVA INC
x1	39007	Matteo countertop washbasin 48 x 37cm	£137.93	184.82€
x1	MC75.01	Podium White gloss countertop, 750 x 450mm	£281.64	377.40€
x1	MC75.03	Podium Zulu wengé countertop, 750 x 450mm	£239.71	321.21€
x1	M0301.1	Podium White gloss drawer unit, 750 x 450mm	£611.24	819.06€
x1	M0303.1	Podium Zulu wengé drawer unit, 750 x 450mm	£611.24	819.06€
Total (WHITE countertop, unit & basin)			£1030.80	1381.28€
Total (ZULU WENGÉ countertop, unit & basin)			£988.88	1325.09€

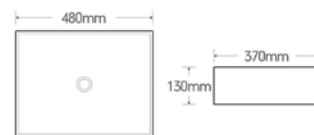

Double-height drawer units are also available for this configuration from the Podium range.
La gamme Podium de mobilier sans poignée propose également des tiroirs double hauteur pour cette configuration.

900mm Countertop

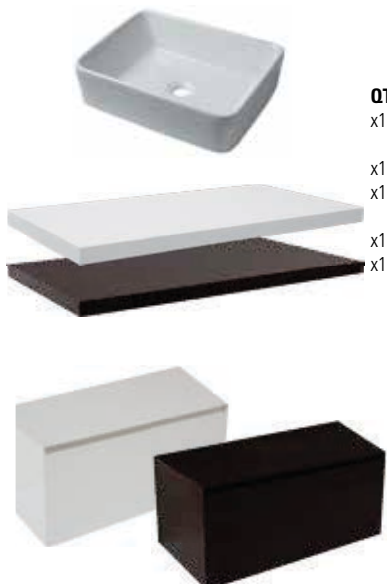

QTY	CODE	DESCRIPTION	INC VAT	TVA INC
x1	39007	Matteo countertop washbasin 48 x 37cm	£137.93	184.82€
x1	MC90.01	Podium White gloss countertop, 900 x 480mm	£358.36	480.21€
x1	MC90.03	Podium Zulu wengé countertop, 900 x 480mm	£311.61	417.56€
x1	M0401.1	Podium White gloss drawer unit, 900 x 480mm	£671.17	899.36€
x1	M0403.1	Podium Zulu wengé drawer unit, 900 x 480mm	£671.17	899.36€
Total (WHITE countertop, unit & basin)			£1,167.46	1564.39€
Total (ZULU WENGÉ countertop, unit & basin)			£1,120.71	1501.74€

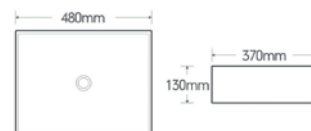

Double-height drawer units are also available for this configuration from the Podium range.
La gamme Podium de mobilier sans poignée propose également des tiroirs double hauteur pour cette configuration.

1000mm Countertop

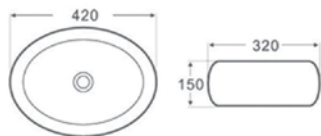

QTY	CODE	DESCRIPTION	INC VAT	TVA INC
x2	39011	Podium countertop washbasin 42 x 32cm	£116.69each	156.37€ l'unité
x1	MC100.01	Podium White gloss countertop, 1000 x 370mm	£343.90	478.72€
x1	MC100.03	Podium Zulu wengé countertop, 1000 x 370mm	£309.00	430.14€
x2	M0101.1	Podium White gloss drawer unit, 500 x 370mm	£484.56 each	674.53€ l'unité
x2	M0103.1	Podium Zulu wengé drawer unit, 500 x 370mm	£484.56 each	674.53€ l'unité

Total (WHITE countertop, unit & basin) £1,546.40 1309.62€
Total (ZULU WENGÉ countertop, unit & basin) £1,511.50 1261.04€



**Double-height drawer units are also available for this configuration from the Podium range.
 La gamme Podium de mobilier sans poignée propose également des tiroirs double hauteur pour cette configuration.**

1200mm Countertop

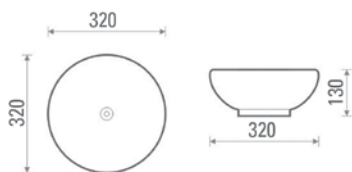

QTY	CODE	DESCRIPTION	INC VAT	TVA INC
x2	50018	Austen sit on bowl 32cm	£134.00 each	179.56€ l'unité
x1	MC120.01	Podium White gloss countertop, 1200 x 420mm	£413.49	554.07€
x1	MC120.03	Podium Zulu wengé countertop, 1200 x 420mm	£353.55	473.76€
x2	M0201.1	Podium White gloss drawer unit, 600 x 420mm	£519.08 each	695.57€ l'unité
x2	M0203.1	Podium Zulu wengé drawer unit, 600 x 420mm	£519.08 each	695.57€ l'unité

Total (WHITE countertop, unit & basin) £1,066.57 1429.20€
Total (ZULU WENGÉ countertop, unit & basin) £1006.63 1348.89€



**Double-height drawer units are also available for this configuration from the Podium range.
 La gamme Podium de mobilier sans poignée propose également des tiroirs double hauteur pour cette configuration.**



1500mm Countertop

QTY	CODE	DESCRIPTION	INC VAT	TVA INC
x2	39007	Matteo countertop washbasin 48 x 37cm	137.93 each	184.82€ l'unité
x1	MC150.01	Podium White gloss countertop, 1500 x 450mm	£551.31	738.75€
x1	MC150.03	Podium Zulu wengé countertop, 1500 x 450mm	£461.40	618.27€
x2	M0301.1	Podium White gloss drawer unit, 750 x 450mm	£611.24 each	819.06€ l'unité
x2	M0303.1	Podium Zulu wengé drawer unit, 750 x 450mm	£611.24 each	819.06€ l'unité
Total (WHITE countertop, unit & basin)			£2,049.65	2,746.51€
Total (ZULU WENGÉ countertop, unit & basin)			£1,959.74	2,626.03€

Double-height drawer units are also available for this configuration from the Podium range.
La gamme Podium de mobilier sans poignée propose également des tiroirs double hauteur pour cette configuration.



1800mm Countertop

QTY	CODE	DESCRIPTION	INC VAT	TVA INC
x2	39007	Matteo countertop washbasin 48 x 37cm	£137.93 each	184.82€ l'unité
x1	MC180.01	Podium White gloss countertop, 1800 x 480mm	£717.90	961.99€
x1	MC180.03	Podium Zulu wengé countertop, 1800 x 480mm	£611.24	819.06€
x2	M0401.1	Podium White gloss drawer unit, 900 x 480mm	£671.17 each	899.36€ l'unité
x2	M0403.1	Podium Zulu wengé drawer unit, 900 x 480mm	£671.17 each	899.36€ l'unité
Total (WHITE countertop, unit & basin)			£2,336.10	3,130.35€
Total (ZULU WENGÉ countertop, unit & basin)			£2,229.44	2,987.42€

Double-height drawer units are also available for this configuration from the Podium range.
La gamme Podium de mobilier sans poignée propose également des tiroirs double hauteur pour cette configuration.



QTY	CODE	DESCRIPTION	INC VAT	TVA INC
x1	MB201	Decorative countertop towel rail bracket (For 600mm & 1200mm countertops)	£158.20	211.99€
x1	MB301	Decorative countertop towel rail bracket (For 750mm & 1500mm countertops)	£166.84	223.56€
x1	MB401	Decorative countertop towel rail bracket (For 900mm & 1800mm countertops)	£172.59	231.27€



Pictured: Project 60107 washbasins with Matteo MC180.01 white gloss countertop and 2 x Matteo handleless M0401.1 white gloss drawer units. Cos C0004 tall basin mixer taps.

Are you serious?...

Yep... I-line back to wall pan with only 49cm projection, cutting edge design and a price tag to match the size

WOW!

Vous êtes sérieux...

Tout à fait... La cuvette classique I-line se caractérise par sa projection de seulement 49 cm, son design dernier cri et son prix abordable.

WOW!

« La projection de la cuvette WC I-line est la plus courte que je connaisse... et des plus appréciées. N'importe qui peut non seulement intégrer cette cuvette WC dans son espace, mais également se permettre de l'acheter ! »

Le directeur d'un magasin de salles de bains, Tavistock (comté du Somerset)

I-LINE

I-LINE

'the projection of the I-line toilet is the smallest I have heard of . . . great value too. Not only can anyone fit it in — anyone can afford it!'

Bathroom showroom manager
Tavistock, Somerset

Pictured: I-line 60634 back to wall WC and matching 60622 basin with 1-drawer unit*. Also featured, STEEL slider shower enclosure and TOOGA T0035 thermostatic rigid riser.

*available Q2 2016

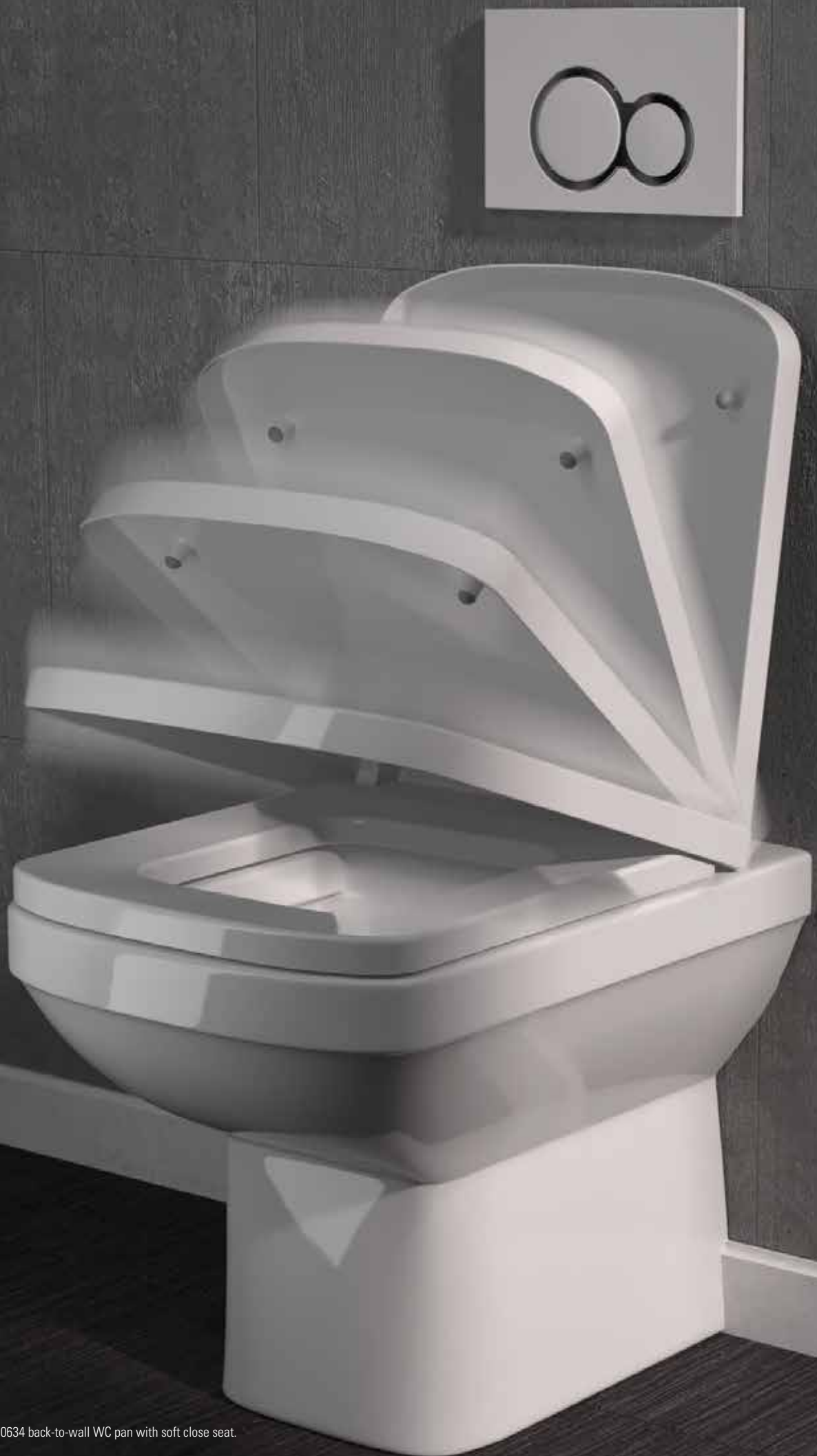

Pictured: I-line 60634 back-to-wall WC pan with soft close seat.

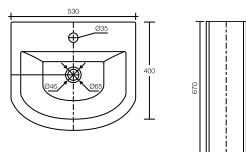

CODE
60610
60612

DESCRIPTION
 I-line 53 x 40cm basin 1 tap hole only
 I-line pedestal

INC VAT
 £80.74
 £35.15

TVA INC
 108.19€
 47.10€

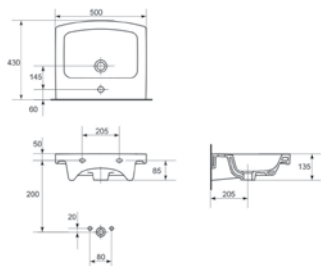

CODE
60620
60624
60625

DESCRIPTION
 I-line 50 x 43cm washbasin 1 tap hole
 I-line pedestal 69cm
 I-line semi-pedestal 31cm

INC VAT
 £111.39
 £74.26
 £84.88

TVA INC
 149.27€
 99.51€
 113.73€

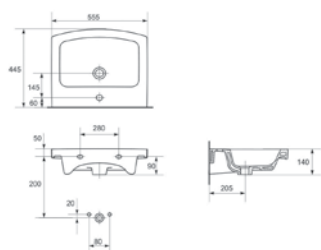

CODE
60621
60624
60625

DESCRIPTION
 I-line 55 x 39cm washbasin 1 tap hole
 I-line pedestal 69cm
 I-line semi-pedestal 31cm

INC VAT
 £121.00
 £74.26
 £84.88

TVA INC
 164.14€
 99.51€
 113.73€

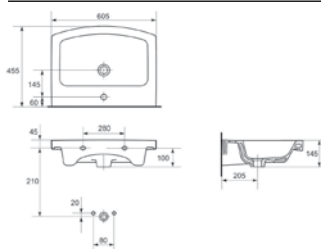

CODE
60622
60624
60625

DESCRIPTION
 I-line 60 x 40cm washbasin 1 tap hole
 I-line pedestal 69cm
 I-line semi-pedestal 31cm

INC VAT
 £131.55
 £74.26
 £84.88

TVA INC
 176.27€
 99.51€
 113.73€

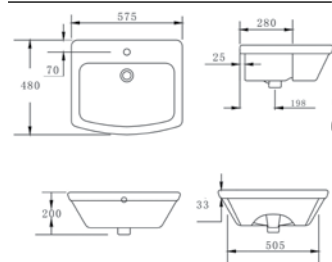

CODE
60614

DESCRIPTION
 I-line 57 x 48cm semi-recessed washbasin

INC VAT
 £230.00

TVA INC
 308.20€

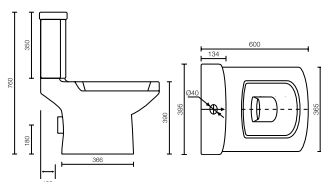

CODE
60630
60631
60633

DESCRIPTION
 I-line close coupled wc pan
 I-line cistern
 I-line soft close seat & cover (quick-release)

INC VAT
 £111.00
 £67.00
 £90.00

TVA INC
 148.74€
 89.78€
 120.60€

Total including soft close seat
 Components WRAS Approved

£268.00 **359.12€**

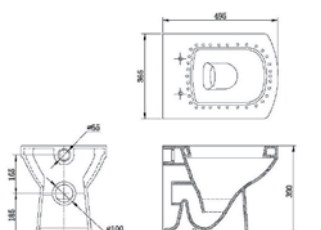

CODE
60634
60633

DESCRIPTION
 I-line back-to-wall wc pan
 I-line soft close seat & cover (quick-release)

INC VAT
 £125.00
 £90.00

TVA INC
 167.50€
 120.60€

Total with cistern and soft close seat
 Available cisterns p.128

£215.00 **288.10€**





CODE
60620

DESCRIPTION
I-line 50 x 43cm washbasin 1 tap hole

INC VAT **TVA INC**
£111.39 149.27€

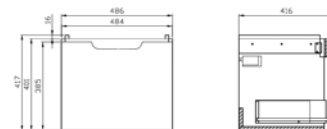

CODE
606101

DESCRIPTION
I-LINE 50 x 39cm 1-drawer unit – white gloss

INC VAT **TVA INC**
£248.20 332.59€

Total for basin and unit

£359.59 481.86€



CODE
60622

DESCRIPTION
I-line 60 x 40cm washbasin 1 tap hole

INC VAT **TVA INC**
£131.55 176.27€

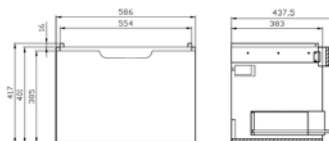

CODE
626102

DESCRIPTION
I-LINE 60 x 40cm 1 drawer unit – white gloss

INC VAT **TVA INC**
£260.98 349.72€

Total for basin and unit

£392.53 525.99€



CODE
60620

DESCRIPTION
I-line 50 x 43cm washbasin 1 tap hole

INC VAT **TVA INC**
£111.39 149.27€



CODE
606201

DESCRIPTION
I-LINE 50 x 38cm 2-door unit – white gloss

INC VAT **TVA INC**
£248.21 332.60€

Total for basin and unit

£359.59 481.86€

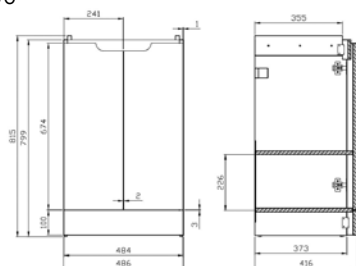

CODE
60622

DESCRIPTION
I-line 60 x 40cm washbasin 1 tap hole

INC VAT **TVA INC**
£131.55 176.27€



CODE
626202

DESCRIPTION
I-LINE 60 x 38cm 2-door unit– white gloss

INC VAT **TVA INC**
£260.98 349.72€

Total for basin and unit

£392.53 525.99€

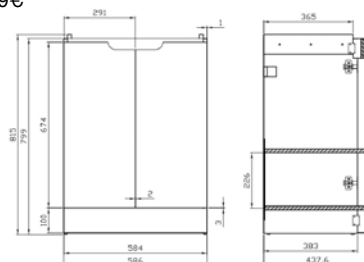



I-LINE

Pictured: I-Line 60622 60 x 40cm washbasin with matching 1-drawer unit . Also featured, TOOGA T0002 basin mixer monoblock.

AUSTEN

symmetry in poetic form

La symétrie sous une forme poétique



Pictured: Austen 50010 60 x 45 cm washbasin with 500203 Austen 60 cm alaksa drawer unit.
Also featured 500633 alaska mirror cabinet and Cos C0001 basin mixer.

AUSTEN

AUSTEN



Pictured: Austen 50074 back-to-wall WC pan with Flushe FP031 flush plate.
Featured, Austen 60cm washbasin with matching unit and mirror in Alaska.



CODE	DESCRIPTION	INC VAT	TVA INC
50000	AUSTEN 50 x 39cm washbasin – 1 tap hole	£120.00	160.80€
50000.0	AUSTEN 50 x 39cm washbasin – no tap hole	£120.00	160.80€
500101	AUSTEN 50cm soft close drawer unit – gloss white	£245.00	328.30€
500103	AUSTEN 50cm soft close drawer unit – alaska	£245.00	328.30€
500107	AUSTEN 50cm soft close drawer unit – pacific walnut	£245.00	328.30€
Total including basin and unit		£365.00	489.10€

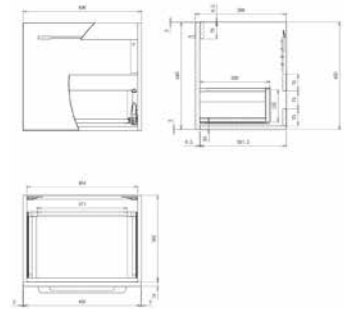

CODE	DESCRIPTION	INC VAT	TVA INC
50010	AUSTEN 60 x 45cm washbasin – 1 tap hole	£140.00	174.20€
50010.0	AUSTEN 60 x 45cm washbasin – no tap hole	£140.00	174.20€
500201	AUSTEN 60cm soft close drawer unit – white gloss	£249.00	333.66€
500203	AUSTEN 60cm soft close drawer unit – alaska	£249.00	333.66€
500207	AUSTEN 60cm soft close drawer unit – pacific walnut	£249.00	333.66€
Total including basin and unit		£379.00	507.86€

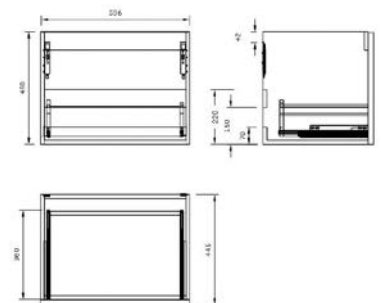
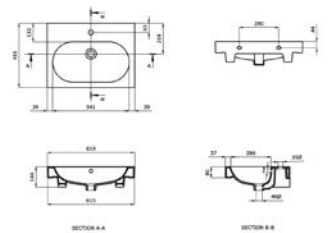

CODE	DESCRIPTION	INC VAT	TVA INC
50011	AUSTEN 72 x 45cm washbasin – 1TH	£145.00	194.30€
500211	AUSTEN 71cm soft close drawer unit – white gloss	£310.00	415.40€
500213	AUSTEN 71cm soft close drawer unit – alaska	£310.00	415.40€
500217	AUSTEN 71cm soft close drawer unit – pacific walnut	£310.00	415.40€
Total including basin and unit		£455.00	609.70€

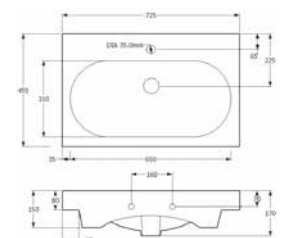



CODE	DESCRIPTION
50000	AUSTEN 50 x 39cm washbasin – 1 tap hole
50000.0	AUSTEN 50 x 39cm washbasin – no tap hole
500111	AUSTEN 50cm soft close 2 door unit – white gloss
500113	AUSTEN 50cm soft close 2 door unit – alaska
500117	AUSTEN 50cm soft close 2 door unit – pacific walnut

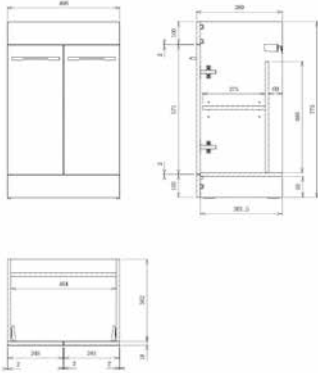

Total including basin and unit

INC VAT	TVA INC
£120.00	160.80€
£120.00	160.80€
£245.00	328.30€
£245.00	328.30€
£245.00	328.30€
£365.00	489.10€



AUSTEN

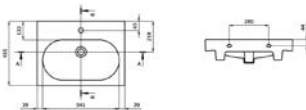

CODE	DESCRIPTION
50010	AUSTEN 60 x 45cm washbasin – 1 tap hole
50010.0	AUSTEN 60 x 45cm washbasin – no tap hole
500301	AUSTEN 60cm soft close 2 door unit – white gloss
500303	AUSTEN 60cm soft close 2 door unit – alaska
500307	AUSTEN 60cm soft close 2 door unit – pacific walnut

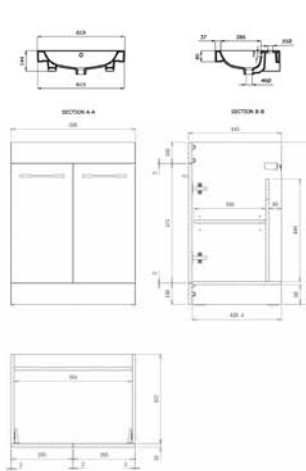

Total including basin and unit

INC VAT	TVA INC
£140.00	174.20€
£140.00	174.20€
£249.00	333.66€
£249.00	333.66€
£249.00	333.66€
£359.00	507.86€

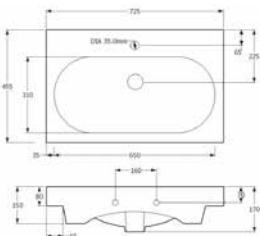

CODE	DESCRIPTION
50011	AUSTEN 72 x 45cm washbasin – 1TH
500311	AUSTEN 71cm soft close 2 door unit – white gloss
500313	AUSTEN 71cm soft close 2 door unit – alaska
500317	AUSTEN 71cm soft close 2 door unit – pacific walnut

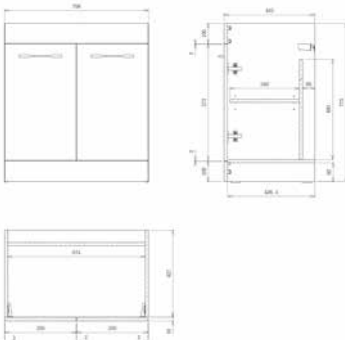

Total including basin and unit

INC VAT	TVA INC
£145.00	194.30€
£310.00	415.40€
£310.00	415.40€
£310.00	415.40€
£455.00	609.70€



600mm countertop, wall-hung unit



Pictured with: NICHOLSON NI104 basin mixer tap

CODE	DESCRIPTION	INC VAT	TVA INC
50018	Austen sit on bowl 32cm	£134.00	179.56€
500681	60cm countertop – white gloss	£41.00	54.94€
500683	60cm countertop – alaska	£41.00	54.94€
500687	60cm countertop - pacific walnut	£41.00	54.94€
500201	60cm soft close drawer unit – white gloss	£249.00	333.66€
500203	60cm soft close drawer unit – alaska	£249.00	333.66€
500207	60cm soft close drawer unit - pacific walnut	£249.00	333.66€
Total (for countertop & bowl with drawer unit)		£424.00	568.16€

600mm countertop, floor-standing unit



Pictured with: NICHOLSON NI104 basin mixer tap

CODE	DESCRIPTION	INC VAT	TVA INC
50018	Austen sit on bowl 32cm	£134.00	166.16€
500681	60cm countertop – white gloss	£41.00	54.94€
500683	60cm countertop – alaska	£41.00	54.94€
500687	60cm countertop – pacific walnut	£41.00	54.94€
500301	60cm soft close 2-door unit – white gloss	£249.00	333.66€
500303	60cm soft close 2-door unit – alaska	£249.00	333.66€
500307	60cm soft close 2-door unit – pacific walnut	£249.00	333.66€
Total (for countertop & bowl with 2-door unit)		£424.00	568.16€

720mm countertop, wall-hung unit



Pictured with: NICHOLSON NI104 basin mixer tap

CODE	DESCRIPTION	INC VAT	TVA INC
50018	Austen sit on bowl 32cm	£134.00	179.56€
500691	72cm countertop – white gloss	£45.00	60.30€
500693	72cm countertop – alaska	£45.00	60.30€
500697	72cm countertop – pacific walnut	£45.00	60.30€
500211	72cm soft close drawer unit – white gloss	£310.00	415.40€
500213	72cm soft close drawer unit – alaska	£310.00	415.40€
500217	72cm soft close drawer unit – pacific walnut	£310.00	415.40€
Total (for countertop & bowl with drawer unit)		£489.00	655.26€

720mm countertop, floor-standing unit



Pictured with: NICHOLSON NI104 basin mixer tap

CODE	DESCRIPTION	INC VAT	TVA INC
50018	Austen sit on bowl 32cm	£134.00	179.56€
500691	72cm countertop – white gloss	£45.00	60.30€
500693	72cm countertop – alaska	£45.00	60.30€
500697	72cm countertop - pacific walnut	£45.00	60.30€
500311	72cm soft close 2-door unit – white gloss	£310.00	415.40€
500313	72cm soft close 2-door unit – alaska	£310.00	415.40€
500217	72cm soft close 2-door unit – pacific walnut	£310.00	415.40€
Total (for countertop & bowl with drawer unit)		£489.00	655.26€

CODE	DESCRIPTION	INC VAT	TVA INC
500601	AUSTEN soft close 2 door mirror cabinet 600mm – white gloss	£240.00	321.60€
500603	AUSTEN soft close 2 door mirror cabinet 600mm – alaska	£240.00	321.60€
500607	AUSTEN soft close 2 door mirror cabinet 600mm – pacific walnut	£240.00	321.60€



CODE	DESCRIPTION	INC VAT	TVA INC
500631	AUSTEN soft close 2 door mirror cabinet 600mm with light and shaver socket – white gloss	£355.00	475.70€
500633	AUSTEN soft close 2 door mirror cabinet 600mm with light and shaver socket – alaska	£355.00	475.70€
500637	AUSTEN soft close 2 door mirror cabinet 600mm with light and shaver socket – pacific walnut	£355.00	475.70€



CODE	DESCRIPTION	INC VAT	TVA INC
500461	AUSTEN soft close side unit 820 x 350 x 280mm – white gloss	£220.00	294.80€
500463	AUSTEN soft close side unit 820 x 350 x 280mm – alaska	£220.00	294.80€
500467	AUSTEN soft close side unit 820 x 350 x 280mm – pacific walnut	£220.00	294.80€



CODE	DESCRIPTION	INC VAT	TVA INC
500451	AUSTEN soft close side unit 1400 x 355 x 250mm – white gloss	£235.00	314.90€
500453	AUSTEN soft close side unit 1400 x 355 x 250mm – alaska	£235.00	314.90€
500457	AUSTEN soft close side unit 1400 x 355 x 250mm – pacific walnut	£235.00	314.90€



CODE	DESCRIPTION	INC VAT	TVA INC
500401	AUSTEN WC unit 841 x 501 x 200mm – white gloss	£235.00	314.90€
500403	AUSTEN WC unit 841 x 501 x 200mm – alaska	£235.00	314.90€
500407	AUSTEN WC unit 841 x 501 x 200mm – pacific walnut	£235.00	314.90€



AUSTEN

AUSTEN WC'S

AUSTEN



Pictured: Austen 50076 wall mounted WC with matching soft close seat.

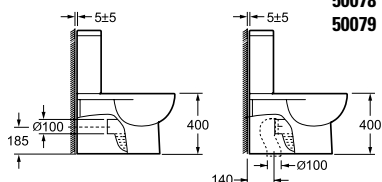
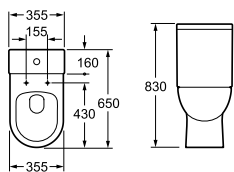

CODE
50070
50071
50073
50078
50079

DESCRIPTION
 Austen close coupled wc pan
 Austen cistern
 Austen soft close seat (for c/c option)
 Austen slim-line soft close seat
 Austen slim-line standard seat

Total with cistern and soft close seat

INC VAT	TVA INC
£160.00	214.40€
£128.00	171.52€
£95.00	127.30€
£102.00	136.68€
£74.00	99.16€

£383.00 513.22€



AUSTEN

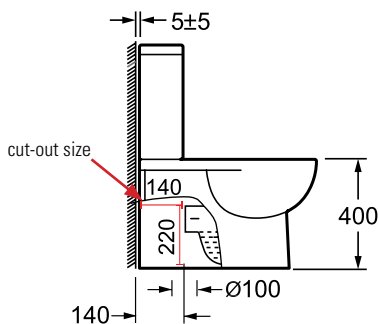

CODE
500701
50071
50073
50078
50079

DESCRIPTION
 Austen close coupled wc pan left hand soil exit
 Austen cistern
 Austen soft close seat (for c/c option)
 Austen slim-line soft close seat
 Austen slim-line standard seat

Total with cistern and soft close seat

INC VAT	TVA INC
£257.00	344.38€
£128.00	171.52€
£95.00	127.30€
£102.00	136.68€
£74.00	99.16€

£480.00 643.20€

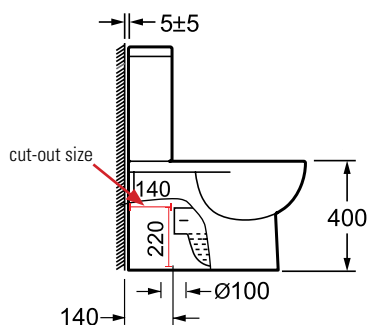

CODE
500702
50071
50073
50078
50079

DESCRIPTION
 Austen close coupled wc pan right hand soil exit
 Austen cistern
 Austen soft close seat (for c/c option)
 Austen slim-line soft close seat
 Austen slim-line standard seat

Total with cistern and soft close seat

INC VAT	TVA INC
£257.00	344.38€
£128.00	171.52€
£95.00	127.30€
£102.00	136.68€
£74.00	99.16€

£480.00 643.20€



Austen WCs

AUSTEN



CODE	DESCRIPTION
50077	AUSTEN close coupled WC, open back
50071	Austen cistern
50073	Austen soft close seat (for c/c option)
50078	Austen slim-line soft close seat
50079	Austen slim-line standard seat



Total with cistern and soft close seat

INC VAT	TVA INC
£135.00	180.90€
£128.00	171.52€
£95.00	127.30€
£102.00	136.68€
£74.00	99.16€

£358.00 479.72€

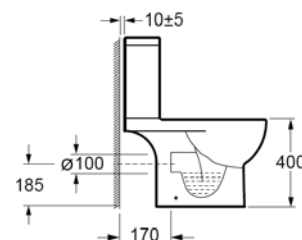
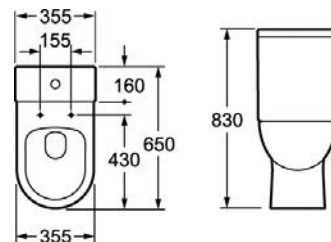

CODE	DESCRIPTION
50074	Austen BTW pan
50073	Austen soft close seat (for c/c option)
50078	Austen slim-line soft close seat
50079	Austen slim-line standard seat



Total with pan and soft close seat

Available cisterns p.128

INC VAT	TVA INC
£160.00	214.40€
£95.00	127.30€
£102.00	136.68€
£74.00	99.16€

£255.00 341.70€

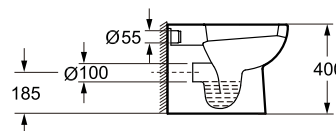
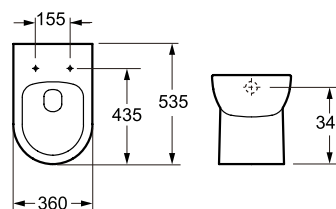

CODE	DESCRIPTION
50076	Austen SLIM wall-mounted WC pan
50075	Austen soft close seat & cover (for SLIM wall-mounted WC)



Total with pan and soft close seat

Available cisterns p.128

INC VAT	TVA INC
£220.00	294.80€
£95.00	127.30€

£315.00 422.10€

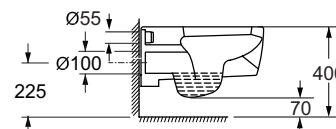
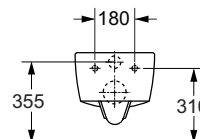
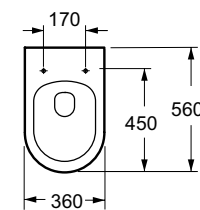

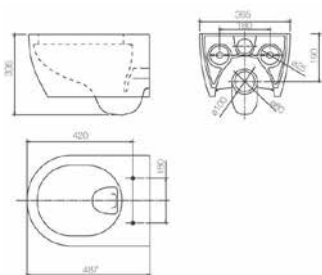

CODE
500.55
500.58

DESCRIPTION
 Austen wall-mounted wc pan
 Soft close seat & cover

Total with pan and soft close seat

Available cisterns p.128

INC VAT
 £305.35
 £160.20

TVA INC
 409.17€
 214.67€

£465.55 **623.84€**



AUSTEN



Pictured: Austen 500.55 wall mounted WC with matching soft-close seat.

Gentle action...
 Our Austen seats come with soft closing action and quick release for easier cleaning. We also offer slim seats for that extra touch of style.

WOW!

Tout en douceur...
 Nos cuvettes WC Austen sont dotées d'un abattant à frein de chute et à ouverture rapide, pour un nettoyage plus facile. Nous proposons également des abattants élancés qui sortent de l'ordinaire.

WOW!



Pictured Left: LOLA free-standing bath with MERCURY free-standing bath shower mixer. Also featured, TEMPUS TE-7212 solo towel rails.

Pictured Right: GLACIER 60cm electric mirror cabinet (avail. 2017) with PRAGUE 60 x 45cm basin and matching 2-drawer unit in gloss white. Also featured, PRAGUE tall side unit in gloss white.



PRAGUE

PRAGUE

PRAGUE



Pictured: PRAGUE 60 x 45cm basin with matching 2-drawer unit in gloss white and GLACIER 50cm electric mirror cabinet (avail. 2017).

Extra holes can be drilled where required for £23.08 inc. VAT each, please quote code ETH when ordering extra tap holes.
All washbasins and units can be wall mounted unless specified.

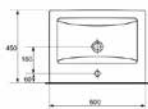

**CODE
PR060**

DESCRIPTION
Prague 60 x 45cm washbasin 1 tap hole

INC VAT £195.00
TVA INC 261.30€

**CODE
PR060.1**

DESCRIPTION
Prague 60cm 2 drawer white gloss unit

INC VAT £400.00
TVA INC 535.99€

Total including washbasin

£595.00 **797.29€**

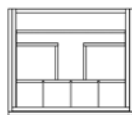
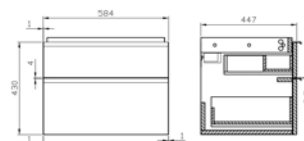
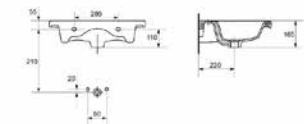

PRAGUE

**CODE
PR040.1**

DESCRIPTION
Prague 150 x 40cm tall white gloss side unit

INC VAT £580.00
TVA INC 777.19€

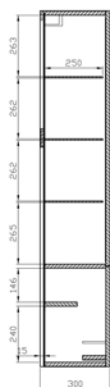

PRAGUE WC'S

PRAGUE



Pictured: Prague PR090 RIMLESS close-coupled WC pan.



CODE	DESCRIPTION
PR090	Prague RIMLESS close-coupled WC pan
PR091	Prague cistern
PR092	Prague STANDARD soft-close seat
PR098	Prague SLIM soft-close seat

Total pan, cistern and soft-close seat

INC VAT	TVA INC
£200.00	268.00€
£110.00	147.41€
£92.16	123.49€
£92.16	123.49€
£402.16	538.90€

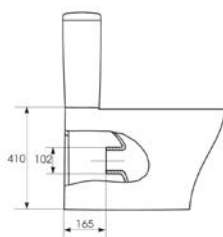
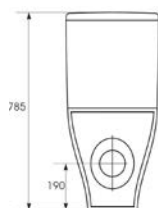

PRAGUE



'the close-coupled WC is in a league of it's own when it comes to rimless technology'

Residential Developer
London, SW6

« La gamme de WC est dans son élément quand elle atteint la technologie sans brides. »

Un installateur de salles de bains, London, SW6



Pictured: 2 x Indigo 700513 1 drawer basin unit with matching 70003 100cm basin and Nicholson NI101 basin mixer. Also featured, Lola 21105 free-standing bath with Tempus TE820 floor-standing BSM.

INDIGO

INDIGO



Indigo

Extra holes can be drilled where required for £23.08 inc. VAT each, please quote code ETH when ordering extra tap holes.
All washbasins and units can be wall mounted unless specified.

CODE **DESCRIPTION** **INC VAT** **TVA INC**
70000 Indigo 50cm washbasin 1 tap hole £135.00 180.90€

CODE **DESCRIPTION** **INC VAT** **TVA INC**
700110 Indigo 50cm 1 drawer white gloss unit £290.00 388.60€
700510 Indigo 50cm 1 drawer grey gloss unit £281.31 376.95€

Total including basin and gloss white unit **£425.00** **569.50€**

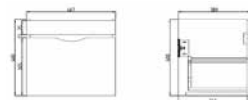
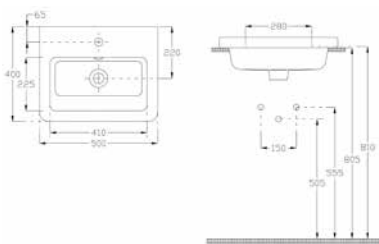

CODE **DESCRIPTION** **INC VAT** **TVA INC**
700120 Indigo 50cm 2 drawer white gloss unit £380.00 509.20€
700520 Indigo 50cm 2 drawer grey gloss unit £369.11 494.61€

Total including basin and gloss white unit **£515.00** **690.10€**

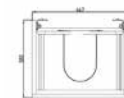
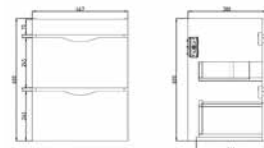
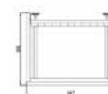

CODE **DESCRIPTION** **INC VAT** **TVA INC**
70001 Indigo 60cm washbasin 1 tap hole £170.00 227.80€

CODE **DESCRIPTION** **INC VAT** **TVA INC**
700111 Indigo 60cm 1 drawer white gloss unit £290.00 388.60€
700511 Indigo 60cm 1 drawer grey gloss unit £290.00 375.35€

Total including basin and gloss white unit **£460.00** **616.40€**

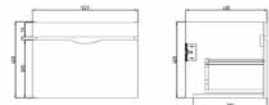
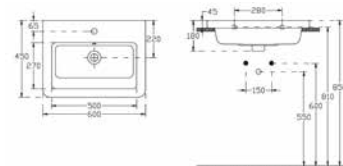

CODE **DESCRIPTION** **INC VAT** **TVA INC**
700121 Indigo 60cm 2 drawer white gloss unit £385.00 515.90€
700521 Indigo 60cm 2 drawer grey gloss unit £372.90 499.69€

Total including basin and gloss white unit **£555.00** **743.70€**

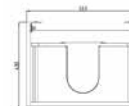



INDIGO

Pictured: INDIGO basin 100cm with NICHOLSON basin mixer monoblock.

Indigo

Extra holes can be drilled where required for £23.08 inc. VAT each, please quote code ETH when ordering extra tap holes.
All washbasins and units can be wall mounted unless specified.

CODE 70002	DESCRIPTION Indigo 80cm washbasin 1 tap hole	INC VAT £200.00	TVA INC 268.00€
-----------------------------	--	---------------------------	---------------------------

CODE 700112	DESCRIPTION Indigo 80cm 1 drawer white gloss unit	INC VAT £375.00	TVA INC 502.50€
700512	Indigo 80cm 1 drawer grey gloss unit	INC VAT £375.00	TVA INC 502.50€

Total including basin and gloss white unit £575.00 770.50€

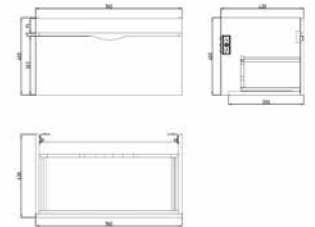
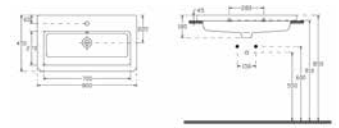

CODE 700122	DESCRIPTION Indigo 80cm 2 drawer white gloss unit	INC VAT £452.00	TVA INC 609.70€
700522	Indigo 80cm 2 drawer grey gloss unit	INC VAT £452.00	TVA INC 609.70€

Total including basin and gloss white unit £652.00 877.70€

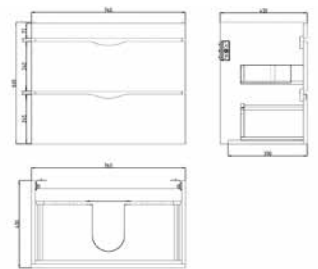

CODE 70003	DESCRIPTION Indigo 100cm washbasin 1 tap hole	INC VAT £210.00	TVA INC 281.40€
-----------------------------	---	---------------------------	---------------------------

CODE 700113	DESCRIPTION Indigo 100cm 1 drawer white gloss unit	INC VAT £385.00	TVA INC 515.90€
700513	Indigo 100cm 1 drawer grey gloss unit	INC VAT £385.00	TVA INC 515.90€

Total including basin and gloss white unit £595.00 797.30€

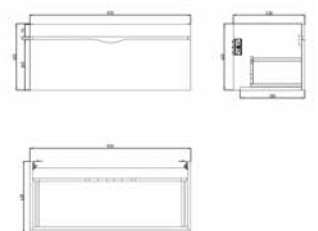
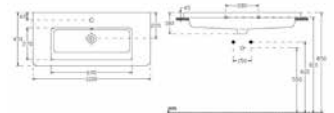

CODE 700123	DESCRIPTION Indigo 100cm 2 drawer white gloss unit	INC VAT £525.00	TVA INC 703.50€
700523	Indigo 100cm 2 drawer grey gloss unit	INC VAT £525.00	TVA INC 703.50€

Total including basin and gloss white unit £735.00 984.90€

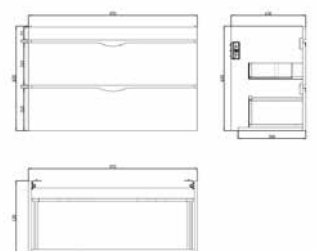



INDIGO

Pictured: INDIGO washbasin and unit. Also featured, TEMPUS TE-7212 solo towel rail.

CODE 70000	DESCRIPTION Indigo 50cm washbasin 1 tap hole	INC VAT £135.00	TVA INC 180.90€
CODE 700100	DESCRIPTION Indigo 50cm 2 door white gloss unit	INC VAT £280.00	TVA INC 375.20€
700500	Indigo 50cm 2 door grey gloss unit	£280.00	375.20€
Total including washbasin		£415.00	556.10€

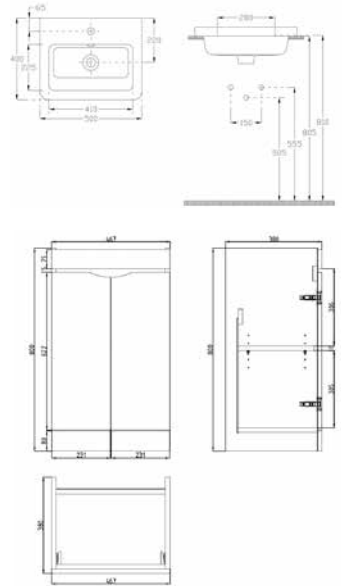

CODE 70001	DESCRIPTION Indigo 60cm washbasin 1 tap hole	INC VAT £170.00	TVA INC 227.80€
CODE 700301	DESCRIPTION Indigo 60cm 2 door white gloss unit	INC VAT £280.00	TVA INC 375.20€
700501	Indigo 60cm 2 door grey gloss unit	£280.00	375.20€
Total including washbasin		£450.00	603.00€

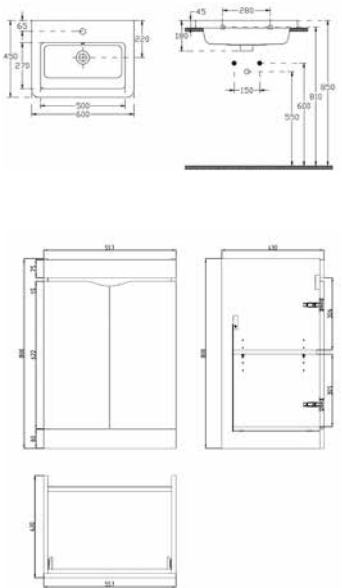

CODE 700305	DESCRIPTION Indigo tall side unit 1400 x 350 x 320mm - gloss white	INC VAT £790.00	TVA INC 1058.61€
700505	Indigo tall side unit 1400 x 350 x 320mm - gloss grey	£790.00	1058.61€

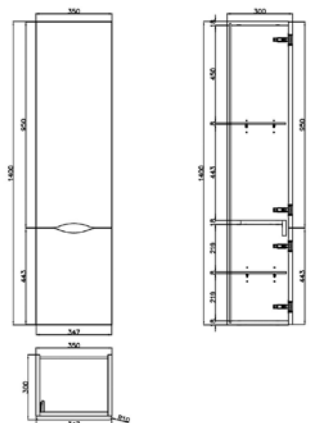



Pictured: INDIGO 140cm side unit in gloss grey.

INDIGO WC'S & BIDETS

INDIGO



Pictured: INDIGO rimless wall-mounted WC pan with matching bidet.

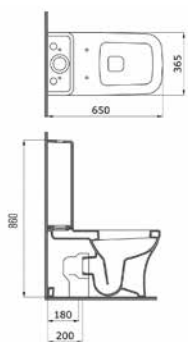

CODE
70110
70111
70112

DESCRIPTION
Indigo close coupled WC pan
Indigo cistern
Indigo soft close seat

INC VAT	TVA INC
£270.00	361.80€
£160.00	214.40€
£95.00	127.30€

Total with cistern and soft close seat

£525.00 703.50€

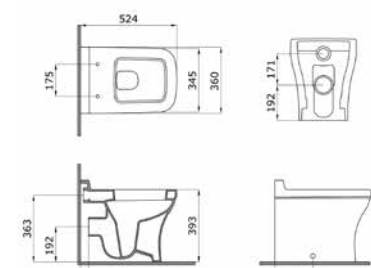

CODE
70114
70112

DESCRIPTION
Indigo back-to-wall WC pan
Indigo soft close seat

INC VAT	TVA INC
£300.00	402.00€
£95.00	127.30€

Total with pan and soft close seat

£395.00 529.30€

Available cisterns p.128

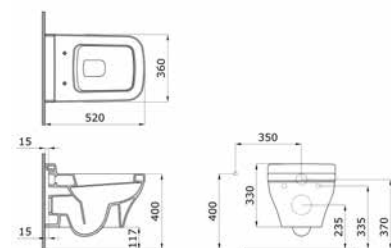

CODE
70116
70112

DESCRIPTION
Indigo wall-hung WC pan
Indigo soft close seat

INC VAT	TVA INC
£345.00	462.30€
£95.00	127.30€

Total with cistern and soft close seat

£440.00 589.60€

Available cisterns p.128

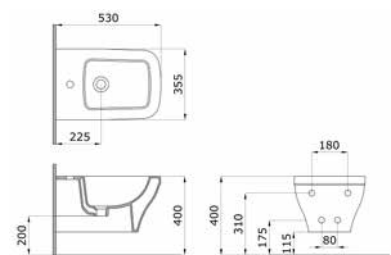

CODE
70115

DESCRIPTION
Indigo wall-hung bidet

INC VAT	TVA INC
£245.00	328.30€

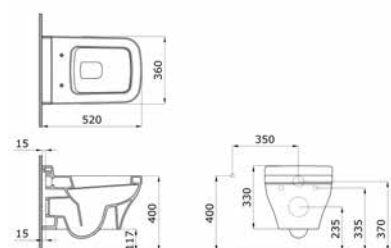

CODE
70117
70112

DESCRIPTION
Indigo wall-hung RIMLESS WC pan
Indigo soft close seat

INC VAT	TVA INC
£345.50	462.30€
£95.00	127.30€

Total with pan and soft close seat

£440.50 589.60€

Available cisterns p.128



INDIGO

POPPY

a modern
classic

POPPY

Une gamme moderne et classique

POPPY

Pictured: Poppy 7710 wall mounted WC with 7760 wall mounted bidet, Poppy 7723 washbasin with PAMQ100 towel rail, Dolce 21104 free standing washbasin.



POPPY



POPPY



Une large gamme de lavabos en céramique de forme cubique et ovale. Poppy est synonyme de joie.

Pictured: 7723 Poppy 100 x 50cm washbasin with PAMQ100 towel rail & Dolcé 21104 freestanding bath. Brassware unavailable.



POPPY

POPPY

'people love Poppy . . . I can't wait to display it with the new glossy furniture'

Bathroom showroom
London

« Les clients adorent la gamme Poppy . . . Je suis impatient de l'exposer avec le nouveau mobilier brillant ! »

Un membre d'un magasin de salles de bains, Londres

POPPY

Pictured: Poppy 7722 80 x 50 washbasin with PF2201 white gloss drawer unit.

Extra holes can be drilled where required for £23.08 inc. VAT each, please quote code ETH when ordering extra tap holes.
All washbasins and units can be wall mounted unless specified.

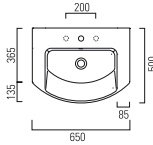

CODE
7732
7732.0

DESCRIPTION
Poppy 65 x 50cm washbasin with overflow 1 tap hole
Poppy 65 x 50cm washbasin with overflow no tap hole

INC VAT	TVA INC
£321.89	431.33€
£321.89	431.33€



PF3201
PF3205

White gloss soft close drawer unit, 650mm
Grey gloss soft close drawer unit, 650mm

£484.56	649.31€
£484.56	649.31€

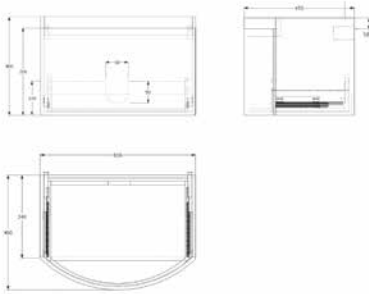
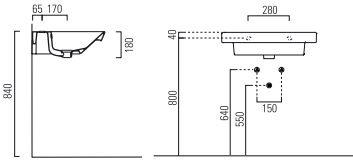

CODE
7722
7722.0

DESCRIPTION
Poppy 80 x 50cm washbasin with overflow 1 tap hole
Poppy 80 x 50cm washbasin with overflow no tap hole

INC VAT	TVA INC
£415.33	556.54€
£415.33	556.54€



PF2201
PF2205

White gloss soft close drawer unit, 800mm
Grey gloss soft close drawer unit, 800mm

£610.30	817.80€
£610.30	817.80€

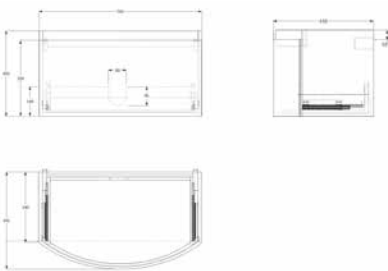
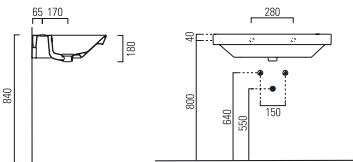
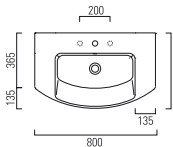

POPPY

Poppy

Extra holes can be drilled where required for £23.08 inc. VAT each, please quote code ETH when ordering extra tap holes.
All washbasins and units can be wall mounted unless specified.



CODE
7732
7732.0
PAMQ65

DESCRIPTION
Poppy 65 x 50cm washbasin with overflow 1 tap hole
Poppy 65 x 50cm washbasin with overflow no tap hole
Towel rail

INC VAT **TVA INC**
£321.89 431.33€
£321.89 431.33€
£166.37 222.93€

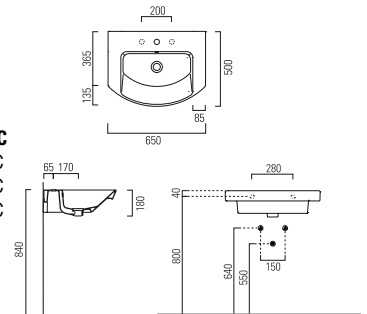

CODE
7722
7722.0
PAMQ80

DESCRIPTION
Poppy 80 x 50cm washbasin with overflow 1 tap hole
Poppy 80 x 50cm washbasin with overflow no tap hole
Towel rail

INC VAT **TVA INC**
£415.33 556.54€
£415.33 556.54€
£178.24 238.85€

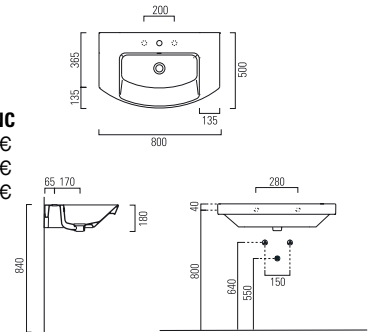

CODE
7723
7723.0
PAMQ100

DESCRIPTION
Poppy 100 x 50cm washbasin with overflow 1 tap hole
Poppy 100 x 50cm washbasin with overflow no tap hole
Towel rail

INC VAT **TVA INC**
£530.70 711.13€
£530.70 711.13€
£219.84 294.58€

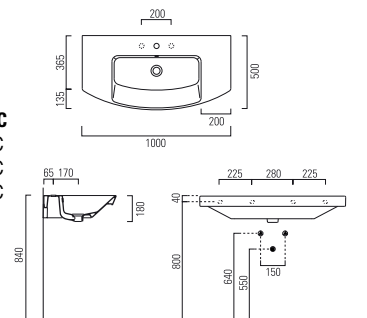

CODE
7724
7724.0
PAMQ120

DESCRIPTION
Poppy 120 x 50cm washbasin with overflow 1 tap hole
Poppy 120 x 50cm washbasin with overflow no tap hole
Towel rail

INC VAT **TVA INC**
£669.14 896.65€
£669.14 896.65€
£231.73 310.51€

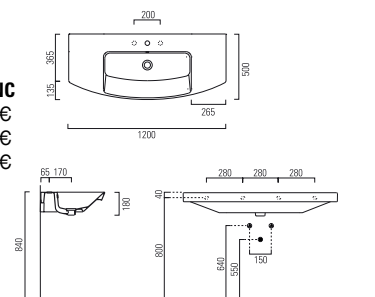

Extra holes can be drilled where required for £23.08 inc. VAT each, please quote code ETH when ordering extra tap holes.
All washbasins and units can be wall mounted unless specified.



Pictured TOP LEFT:
POPPY 7732 washbasin with PF3201 soft close unit. Also featured,
MERCURY ME004 three hole basin lever mixer & IN001 mirror cabinet



Pictured TOP RIGHT:
POPPY 7722 washbasin with matching chrome towel rail.



Pictured:
POPPY 7712 wall mounted WC pan with 7732 washbasin with
matching unit. Also, Tempus TE-7086 towel rail.

POPPY

POPPY WC'S & BIDETS

POPPY



POPPY

Pictured: Poppy 7713 back to wall pan with 7763 back to wall bidet.

Poppy WCs & Bidets



CODE
7710
MS7511
MS7511.C

DESCRIPTION
Poppy SLIM wall-mounted wc
Poppy standard seat
Soft close seat & cover

Total with wc and soft close seat

Available cisterns p.128

INC VAT	TVA INC
£267.59	358.57€
£128.13	171.69€
£158.70	212.66€
£426.29	571.23€

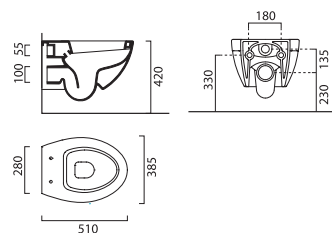

CODE
7760

DESCRIPTION
Poppy SLIM wall-mounted bidet

INC VAT	TVA INC
£398.08	533.43€

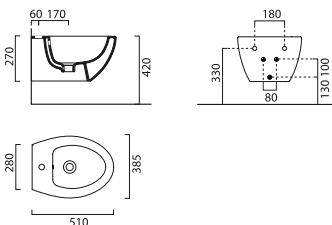

CODE
7712
MS7511
MS7511.C

DESCRIPTION
Poppy wall-mounted wc – big
Poppy standard seat
Soft close seat & cover

Total with wc and soft close seat

Available cisterns p.128

INC VAT	TVA INC
£556.00	745.05€
£128.13	171.69€
£158.70	212.66€
£714.70	957.71€

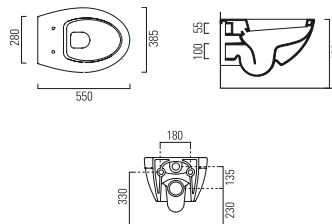

CODE
7713
MS7511
MS7511.C

DESCRIPTION
Poppy back-to-wall wc pan – big
Poppy standard seat
Soft close seat & cover

Total with wc and soft close seat

Available cisterns p.128

INC VAT	TVA INC
£295.28	395.67€
£128.13	171.69€
£158.70	212.66€
£582.11	780.02€

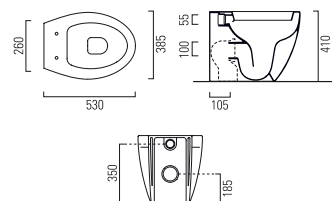

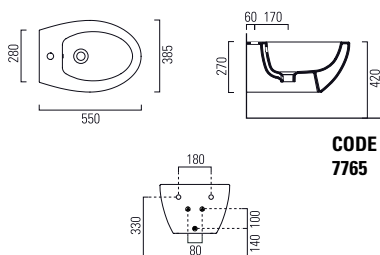

CODE
7765

DESCRIPTION
Poppy wall-mounted bidet – big - no taphole

INC VAT **TVA INC**
£576.32 772.27€

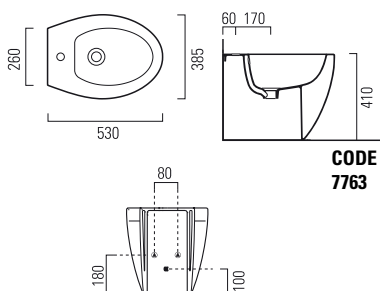

CODE
7763

DESCRIPTION
Poppy back-to-wall bidet – big - no taphole

INC VAT **TVA INC**
£546.62 732.47€



CODE
MS7511.C
MS7511

DESCRIPTION
Soft close seat & cover
Poppy standard seat

INC VAT **TVA INC**
£158.70 212.66€
£128.13 171.69€

X_ACT

Our new mineral marble basins encompass the contemporary bathroom concept and vision. As a product of a truly unique idea and design, the X_ACT range of washbasins is one of a kind. Its refined composition and even material make from an exceptionally smooth and glossy finish.

As mineral marble is molded into an extra- smooth surface, it has the ability to be shaped in precise measurements that are not achievable with regular ceramic materials. The basins can be matched with our reputable units from our AUSTEN range in gloss white, alaska and pacific walnut colours.

Boasting a lighter and more durable material as well as easy installation and competitive prices, the X_ACT basins are a great choice for any bathroom.

Nos nouveaux lavabos en marbre minéral embrassent le concept et la vision des salles de bains contemporaines. La gamme de lavabos X_ACT, dont le concept et le design sont véritablement uniques, n'est pas une gamme comme les autres. Elle se caractérise par sa composition raffinée, ses matériaux uniformes et sa finition exceptionnellement lisse et brillante.

Le marbre minéral est moulé de sorte à obtenir une surface extra-lisse. Il peut ainsi être façonné avec précision, ce qui n'est pas possible avec des matériaux en céramique ordinaires. Il est possible d'allier ces lavabos avec les célèbres meubles de notre gamme AUSTEN aux finitions blanc satiné, alaska et noisette pacifique.

Fabriqués à partir d'un matériau plus léger et plus durable, faciles à installer et vendus à des prix compétitifs, les lavabos X_ACT constituent un choix idéal pour n'importe quelle salle de bains.



X_ACT

Pictured: X_ACT 60cm washbasin and Pascale PA001 with matching AUSTEN 1-drawer unit in alaska. Also featured, Inside IN001 recessed mirror cabinet.

CODE	DESCRIPTION
XA60	X_ACT 60 x 46cm washbasin – 1TH
500201	AUSTEN 60cm soft close drawer unit – white gloss
500203	AUSTEN 60cm soft close drawer unit – alaska
500207	AUSTEN 60cm soft close drawer unit – pacific walnut
Total	

INC VAT	TVA INC
£160.00	214.40€
£249.00	333.66€
£249.00	333.66€
£249.00	333.66€
£409.00	548.06€

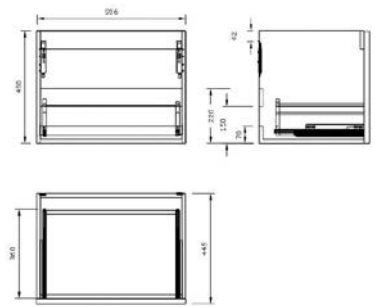
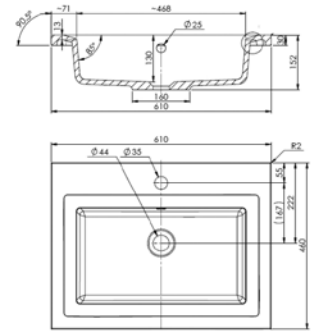

CODE	DESCRIPTION
XA72	X_ACT 72 x 46cm washbasin – 1TH
500211	AUSTEN 71cm soft close drawer unit – white gloss
500213	AUSTEN 71cm soft close drawer unit – alaska
500217	AUSTEN 71cm soft close drawer unit – pacific walnut
Total	

INC VAT	TVA INC
£180.00	241.20€
£310.00	415.40€
£310.00	415.40€
£310.00	415.40€
£490.00	656.60€

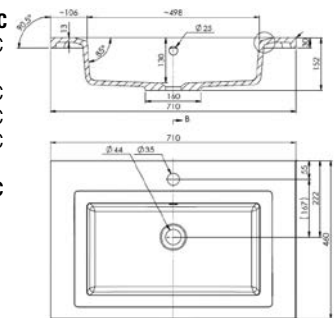

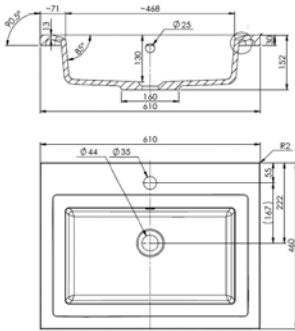

CODE	DESCRIPTION	INC VAT	TVA INC
XA60	X_ACT 60 x 46cm washbasin – 1TH	£160.00	214.40€
500301	AUSTEN 60cm soft close floor standing unit – white gloss	£249.00	333.66€
500303	AUSTEN 60cm soft close floor standing unit – alaska	£249.00	333.66€
500307	AUSTEN 60cm soft close floor standing unit – pacific walnut	£249.00	333.66€
Total		£409.00	548.06€

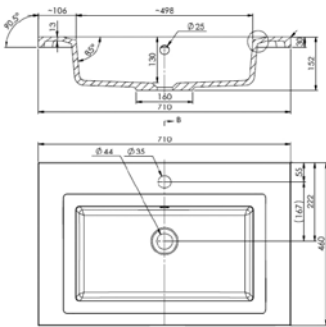
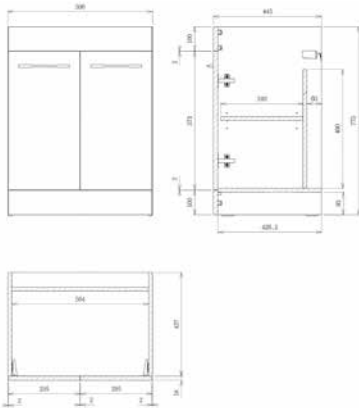

CODE	DESCRIPTION	INC VAT	TVA INC
XA72	X_ACT 72 x 46cm washbasin – 1TH	£180.00	241.20€
500311	AUSTEN 71cm soft close floor standing unit – white gloss	£310.00	415.40€
500313	AUSTEN 71cm soft close floor standing unit – alaska	£310.00	415.40€
500317	AUSTEN 71cm soft close floor standing unit – pacific walnut	£310.00	415.40€
Total		£490.00	656.60€

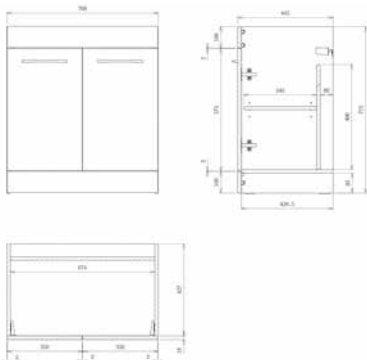

X_ACT



UNI

UNI

perfection
in a small
package

La perfection dans un produit compact

Pictured: Uni 66001 46 x 32cm semi recess washbasin, Cos C0002 small basin mixer, Uni 66100 BTW WC & Flushe HC1036 830mm cistern with FP037 stainless steel flush plate.



Gently action...

Our UNI seats come with soft closing action and quick release for easier cleaning. We also offer slim seats for that extra touch of style.

WOW!

Tout en douceur...

Nos cuvettes WC UNI sont dotées d'un abattant à frein de chute et à ouverture rapide, pour un nettoyage plus facile. Nous proposons également des abattants élancés qui sortent de l'ordinaire.

WOW!

UNI SEMI- RECESSED, UNDERCOUNTER & SIT-ON BASINS

UNI SEMI-RECESSED, UNDERCOUNTER & SIT-ON BASINS

Pictured: Uni 66003 46cm circular semi-recessed washbasin & Easy 0 E0001 basin mixer.

Extra holes can be drilled where required for £18.72 each, please quote code ETH when ordering extra tap holes.
All washbasins and units can be wall mounted unless specified.

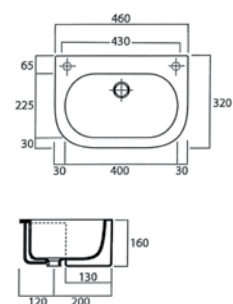

CODE	DESCRIPTION	INC VAT	TVA INC
66001	Uni 46 x 32cm semi-recessed washbasin no tap hole	£250.00	335.00€
66001.LH	Uni 46 x 32cm semi-recessed washbasin left hand tap hole	£250.00	335.00€
66001.RH	Uni 46 x 32cm semi-recessed washbasin right hand tap hole	£250.00	335.00€

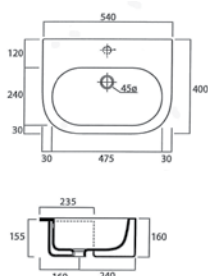

CODE	DESCRIPTION	INC VAT	TVA INC
66002	Uni 54 x 40cm semi-recessed washbasin 1 tap hole	£260.00	348.40€
66002.0	Uni 54 x 40cm semi-recessed washbasin no tap hole	£260.00	348.40€

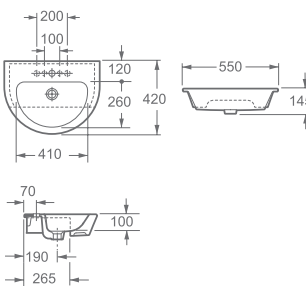

CODE	DESCRIPTION	INC VAT	TVA INC
50019	AUSTEN semi recessed washbasin 54 x 42cm	£149.00	199.66€

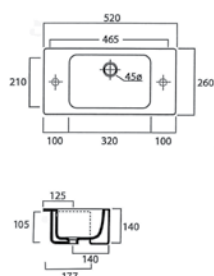

CODE	DESCRIPTION	INC VAT	TVA INC
69001	Uni 52 x 26cm semi-recessed washbasin no taphole	£265.00	355.10€
69001.LH	Uni 52 x 26cm semi-recessed washbasin left hand taphole	£265.00	355.10€
69001.RH	Uni 52 x 26cm semi-recessed washbasin right hand taphole	£265.00	355.10€

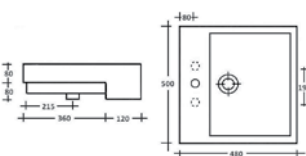

CODE	DESCRIPTION	INC VAT	TVA INC
QU48	Quadro semi-recessed washbasin 1 tap hole	£341.30	457.34€
QU48.0	Quadro semi-recessed washbasin no tap hole	£341.30	457.34€

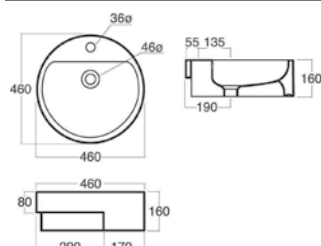

CODE	DESCRIPTION	INC VAT	TVA INC
66003	Uni 46cm circular semi-recessed washbasin 1 tap hole	£255.00	341.70€





CODE
39100

DESCRIPTION
Undercounter washbasin 50 x 41cm

INC VAT £363.41
TVA INC 486.97€

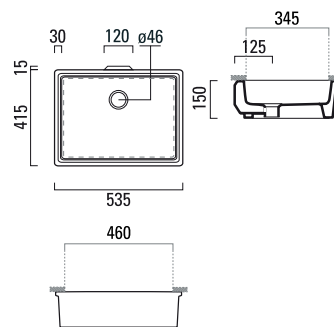

CODE
39101

DESCRIPTION
Undercounter washbasin 84 x 46cm

INC VAT £323.03
TVA INC 432.86€

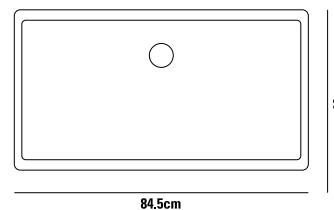

CODE
39103

DESCRIPTION
Undercounter washbasin 70 x 38cm

INC VAT £380.73
TVA INC 510.17€

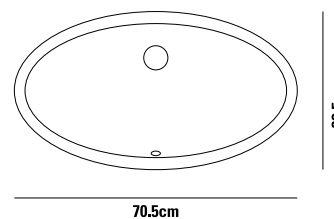

CODE
39104

DESCRIPTION
Undercounter washbasin 93 x 38cm

INC VAT £449.94
TVA INC 602.93€

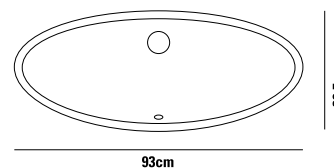

CODE
39106

DESCRIPTION
Undercounter washbasin 49 x 37cm

INC VAT £236.50
TVA INC 316.91€

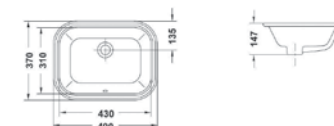

CODE
39107

DESCRIPTION
Undercounter washbasin 57 x 42cm

INC VAT £201.86
TVA INC 270.79€

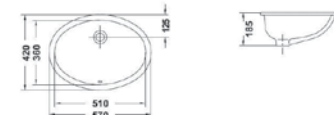

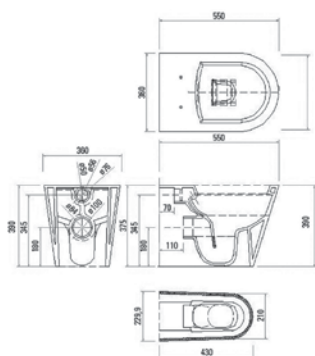

CODE
66100
66101

DESCRIPTION
Uni BTW pan
Uni wc seat & cover – soft close

Total with wc and soft close seat

Available cisterns p.128

INC VAT	TVA INC
£240.00	321.60€
£90.00	120.60€

£330.00	442.20€
----------------	----------------

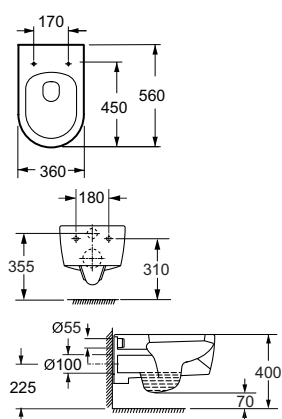

CODE
50076
50075

DESCRIPTION
Uni wall-mounted WC pan
Uni soft close seat & cover (for wall-mounted WC)

Total with wc and soft close seat

Available cisterns p.128

INC VAT	TVA INC
£220.00	294.80€
£95.00	127.30€

£315.00	422.10€
----------------	----------------



QUADRO



QUADRO

Pictured: QUADRO QU2201 basin+unit, in cashew.

Quadro

Extra holes can be drilled where required for £23.08 inc. VAT each, please quote code ETH when ordering extra tap holes.
All washbasins and units can be wall mounted unless specified.



CODE
QU20
PA20

DESCRIPTION
Quadro 40 x 20cm washbasin – right hand taphole only
Chrome towel rail

INC VAT £194.97
TVA INC 261.26€
£69.22 92.75€

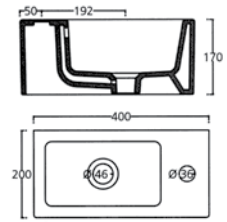

CODE
QU17
QU17.0
PA50

DESCRIPTION
Quadro 50 x 27cm washbasin inc. overflow 1 tap hole
Quadro 50 x 27cm washbasin inc. overflow no tap hole
Chrome towel rail

INC VAT £218.05
TVA INC 292.19€
£218.05 292.19€
£79.61 106.67€

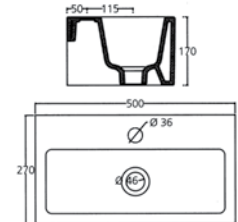

CODE
QU27
QU27.0

DESCRIPTION
50 x 27cm washbasin no overflow 1 tap hole
50 x 27cm washbasin no overflow no tap hole

INC VAT £237.67
TVA INC 318.48€
£237.67 318.48€

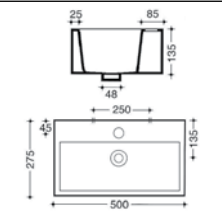

CODE
QU30
QU30.0
PA30

DESCRIPTION
Quadro 30 x 30cm washbasin 1 tap hole
Quadro 30 x 30cm washbasin no tap hole
Chrome towel rail

INC VAT £194.97
TVA INC 261.26€
£194.97 261.26€
£69.22 92.75€

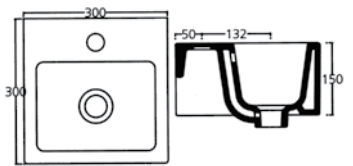

CODE
QU30c-lo
QU30c-dw

DESCRIPTION
Light oak wall-mounted cabinet for QU30
Dark walnut wall-mounted cabinet for QU30

INC VAT £220.00
TVA INC 294.80€
£220.00 294.80€

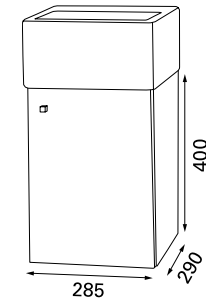

CODE
QU36
PA36

DESCRIPTION
Quadro 36cm corner washbasin 1 tap hole
Chrome corner towel rail

INC VAT £201.86
TVA INC 270.49€
£73.83 98.93€

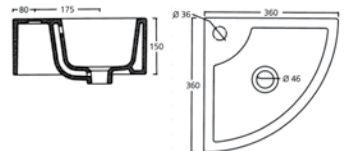

CODE
QU36c-lo
QU36c-dw

DESCRIPTION
Light oak corner cabinet for QU36
Dark walnut corner cabinet for QU36

INC VAT £279.07
TVA INC 373.95€
£279.07 373.95€

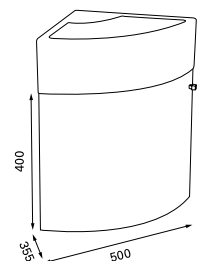

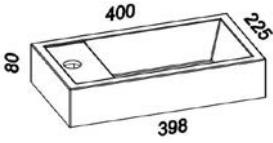

CODE
QU2201
QU2203

QU2211
QU2213

DESCRIPTION
 Basin + unit floor-mounted – white gloss
 Basin + unit floor-mounted – pretoria oak

 Basin + unit wall-mounted – white gloss
 Basin + unit wall-mounted – pretoria oak

INC VAT	TVA INC
£220.00	294.80€
£240.00	321.60€
£220.00	294.80€
£240.00	321.60€

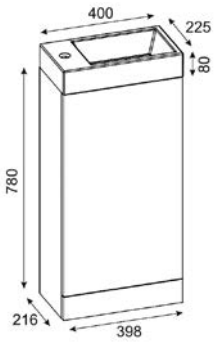

QUADRO

PLAZA



Cutting edge design makes Plaza a bathroom classic.

Plaza is the new 'old'. Plaza is accentuated in design by the beautiful marriage of traditional ceramic looks with cutting-edge technology of the wall-mounted WC.

PLAZA – a tradition in innovation.

La conception dernier cri de la gamme Plaza en fait un classique des salles de bains.

La gamme Plaza est le nouveau « vieux ». Le design de cette gamme est accentué par la merveilleuse alliance de l'aspect céramique traditionnel et de la technologie de pointe des cuvettes WC classiques.

PLAZA - La tradition dans l'innovation

Pictured: PLAZA 60703 washbasin 100 x 50cm w/GEORGETTE 60400 3-hole basin mixer.
Also featured, 60716 wall-hung WC.

Extra holes can be drilled where required for £18.72 each, please quote code ETH when ordering extra tap holes.
All washbasins and units can be wall mounted unless specified.



CODE
60701
60710

DESCRIPTION
Plaza 60 x 50cm washbasin
Plaza pedestal 74cm

INC VAT
£254.62
£118.82

TVA INC
341.19€
159.21€

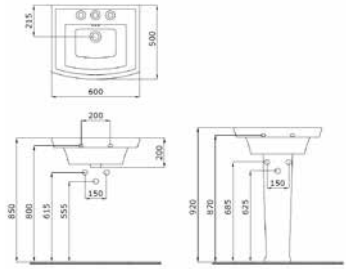

CODE
60703

DESCRIPTION
Plaza 100 x 50cm washbasin – 1TH

INC VAT
£583.49

TVA INC
781.88€

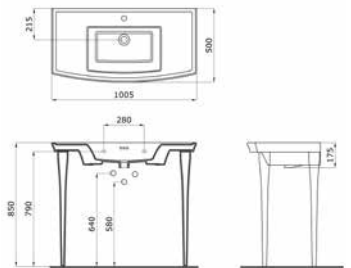

60703.2
2 leg version

CODE
60703.2
60703.4

DESCRIPTION
Plaza legs x 2
Plaza legs x 4

INC VAT
£206.88
£407.77

TVA INC
277.21€
546.41€

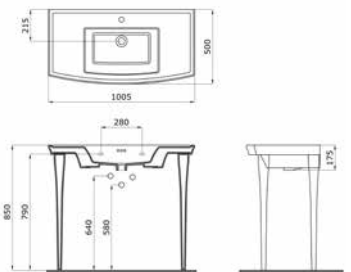

CODE
60716
60712

DESCRIPTION
Plaza wall-hung WC pan
Plaza seat & cover

INC VAT
£466.80
£169.74

TVA INC
625.51€
227.45€

Total with seat & cover

£636.54 **852.96€**

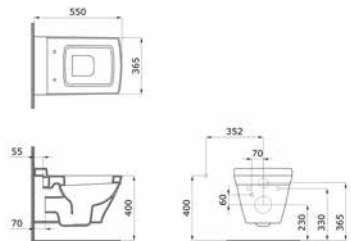

CODE
60712

DESCRIPTION
Plaza seat & cover

INC VAT
£169.74

TVA INC
227.45€



'the lines of Project are superb . . . love the practical thin edge of the basin, such a good use of wash space'

Consumer

Keston Park, Bromley, BR2

« Les lignes de la gamme Project sont sublimes . . . j'adore les bords fins du lavabo et l'utilisation qui est faite de l'espace. »

Un client de Keston Park, Bromley (district de Bromley)

Project range includes a fully back to wall toilet with 7 basins in the range, you have impressive selection. In creating Project, we combine the finer elements of design, with a wonderfully softened square edge.

Any Project - anywhere - for anyone

We save you space...

Our Project range is specifically design to make the most out of your space while giving you the freedom to express your personal style.

WOW!

Nous vous faisons économiser de l'espace

... Notre gamme Project est spécialement conçue pour vous permettre d'exploiter au mieux votre espace tout en vous offrant la liberté d'exprimer votre propre style.

WOW!



La gamme Project comprend une cuvette WC classique et 7 lavabos. En créant cette gamme, nous sommes parvenus à associer les éléments les plus fins du design aux bords droits merveilleusement lisses des produits.

N'importe quel projet, n'importe où, quelle que soit la personne.

PROJECT

Pictured: Project 60130 CC WC & 60140 bidet with cover, 60116 60 x 45cm basin & pedestal, Tempus TA260 toilet roll holder.



CODE
60107

DESCRIPTION
Project counter top washbasin 50 x 38cm - no overflow

INC VAT £194.04
TVA INC 260.02€

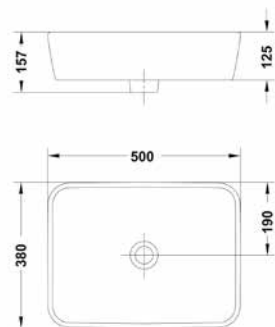

CODE
60108

DESCRIPTION
Project recess washbasin 55 x 42cm 1 tap hole only

INC VAT £235.21
TVA INC 315.19€

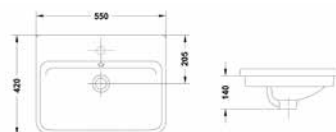

CODE
60111
60114

DESCRIPTION
Project 55 x 35cm washbasin 1 tap hole only
Semi-pedestal 20 x 30cm

INC VAT £162.29
£129.37
TVA INC 217.47€
173.36€

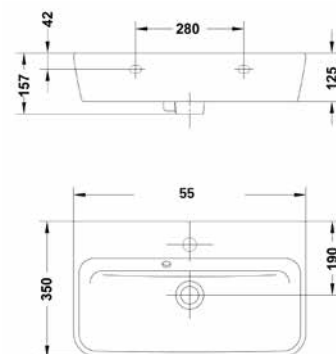

CODE
60112
60113
60114

DESCRIPTION
Project 60 x 35cm washbasin 1 tap hole only
Pedestal
Semi-pedestal 20 x 30cm

INC VAT £217.57
£109.37
£129.37
TVA INC 291.54€
146.56€
173.36€

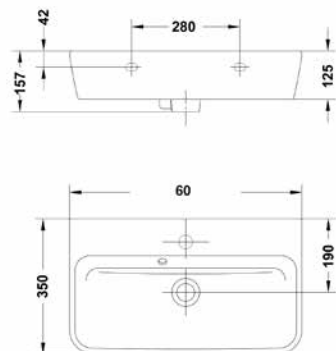

CODE
60115
60113
60114

DESCRIPTION
Project 55 x 45cm washbasin 1 tap hole only
Pedestal
Semi-pedestal 20 x 30cm

INC VAT £164.65
£109.37
£129.37
TVA INC 220.63€
146.56€
173.36€

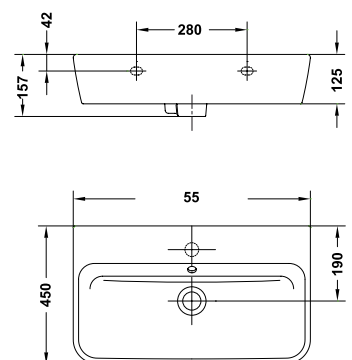

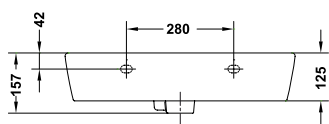

CODE
60116
60113
60114

DESCRIPTION
Project 60 x 45cm washbasin 1 tap hole only
Pedestal
Semi-pedestal 20 x 30cm

INC VAT **TVA INC**
£199.94 267.92€
£109.37 146.56€
£129.37 173.36€

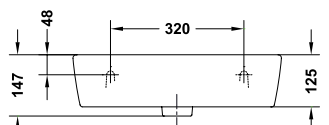
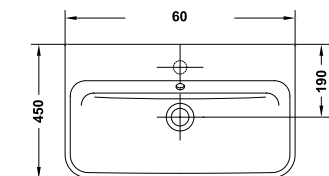

CODE
60100

DESCRIPTION
Project 50 x 25cm washbasin right hand tap hole only
(wall hung only)

INC VAT **TVA INC**
£164.65 220.63€

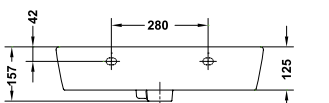
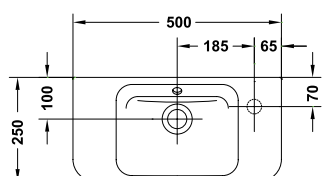

CODE
60110
60114
60113

DESCRIPTION
Project 50 x 35cm washbasin 1 tap hole only
Semi-pedestal 20 x 30cm
Pedestal

INC VAT **TVA INC**
£158.77 212.75€
£129.37 173.36€
£109.37 146.56€

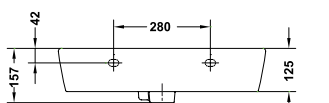
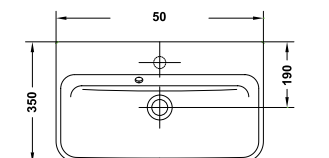

CODE
60120

DESCRIPTION
Project 80 x 35cm washbasin 1 tap hole only
(wall hung only)

INC VAT **TVA INC**
£299.89 401.85€

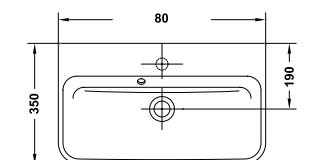



CODE
60130 Project close coupled wc pan
60131 Project cistern
60133c Project soft close seat for c/c option

Total including standard seat

INC VAT **TVA INC**
 £236.83 317.36€
 £160.12 214.56€
 £149.85 200.79€

£386.68 518.15€

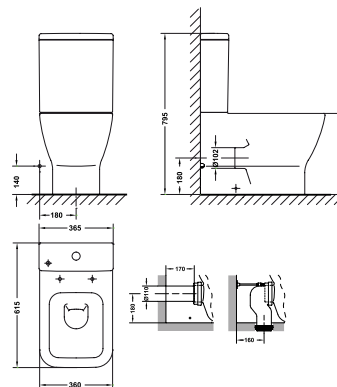

CODE
601301 Project close coupled wc pan. L/H soil exit
60131 Project cistern
60133c Project soft close seat for c/c option

Total including standard seat

INC VAT **TVA INC**
 £306.31 410.46€
 £160.12 214.56€
 £149.85 200.79€

£456.16 611.25€

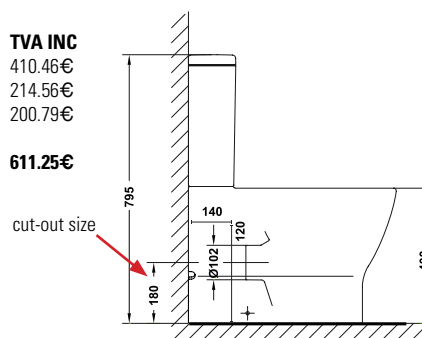

CODE
601302 Project close coupled wc pan. R/H soil exit
60131 Project cistern
60133c Project soft close seat for c/c option

Total including standard seat

INC VAT **TVA INC**
 £306.31 410.46€
 £160.12 214.56€
 £149.85 200.79€

£456.16 611.25€

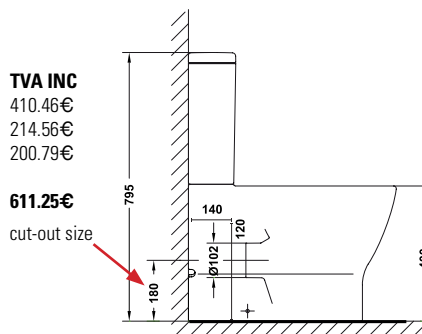

CODE
60133c Project soft close seat for c/c option
60133w Project soft close seat for w/h option

INC VAT **TVA INC**
 £145.00 200.79€
 £145.00 200.79€

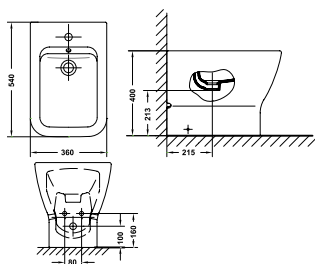

CODE
60140

DESCRIPTION
Project bidet

INC VAT **TVA INC**
£240.99 322.92€

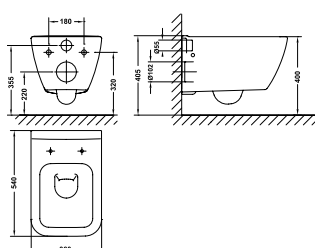

CODE
60155
60133w

DESCRIPTION
Project wc pan – wall hung
Project soft close seat for w/h option

INC VAT **TVA INC**
£377.75 506.19€
£149.85 200.79€

Total with wc and soft close seat
Available cisterns p.128

£527.60 **706.98€**

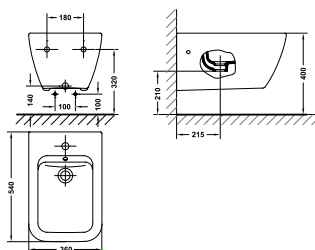

CODE
60156
60141

DESCRIPTION
Project bidet – wall hung
Project bidet cover

INC VAT **TVA INC**
£339.16 454.48€
£115.07 154.20€

Total with cover

£454.23 **608.68€**



YLO

innovative
geometric
shapes

YLO unveils a new contemporary solution for the bathroom; a revolutionary concept which has inspired many interior designers and architects alike.

Des formes
géométriques
innovantes

La gamme YLO dévoile une nouvelle solution contemporaine pour la salle de bains ; un concept révolutionnaire qui a inspiré de nombreux architectes et décorateurs d'intérieur.



Pictured: YLO 06001 48 x 48cm washbasin & YLO101 white gloss drawer unit, Easy O E0001 basin mixer & YLO 06011 back-to-wall WC.

Ylo

Extra holes can be drilled where required for £23.08 inc. VAT each, please quote code ETH when ordering extra tap holes.
All washbasins and units can be wall mounted unless specified.



CODE
06001
06001.0

DESCRIPTION
Ylo 48 x 48cm washbasin 1 tap hole
Ylo 48 x 48cm washbasin no tap hole

INC VAT **TVA INC**
£343.80 460.69€
£343.80 460.69€

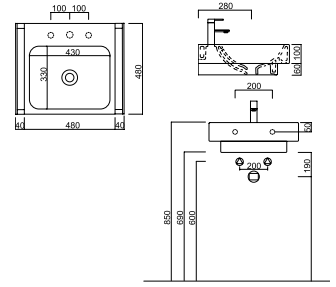

CODE
YLO101

DESCRIPTION
White gloss soft close drawer unit

INC VAT **TVA INC**
£351.88 471.52€

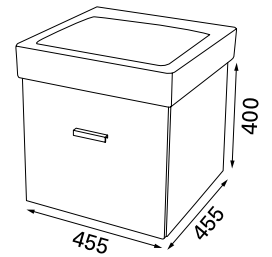

CODE
06002
06002.0

DESCRIPTION
Ylo 100 x 48cm washbasin 1 tap hole
Ylo 100 x 48cm washbasin no tap hole

INC VAT **TVA INC**
£669.14 896.65€
£669.14 896.65€

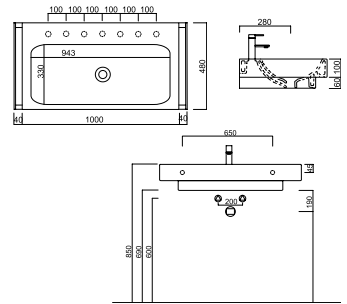

CODE
YLO201

DESCRIPTION
White gloss soft close drawer unit

INC VAT **TVA INC**
£536.48 718.88€

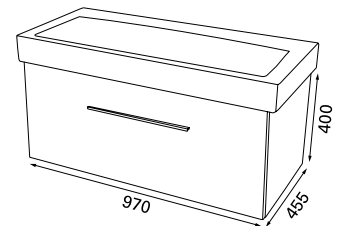

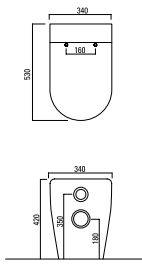

CODE
06011
06119
06120

DESCRIPTION
 Ylo back-to-wall wc pan
 Seat & cover
 Soft close seat & cover

INC VAT **TVA INC**
 £473.93 635.07€
 £124.77 167.20€
 £166.37 222.93€

Total with wc and soft close seat
 Available cisterns p.128

£640.30 **658.00€**

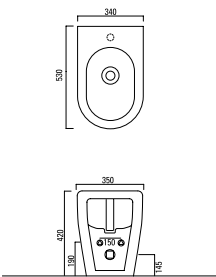

CODE
06012

DESCRIPTION
 Ylo back-to-wall bidet

INC VAT **TVA INC**
 £475.32 636.92€

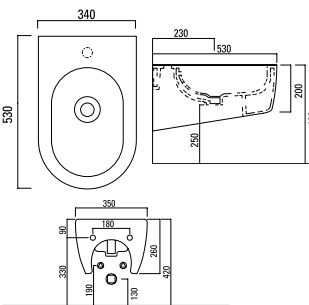

CODE
06010

DESCRIPTION
 Ylo wall-mounted bidet

INC VAT **TVA INC**
 £545.44 730.89€

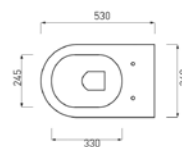

CODE
06229
06119
06120

DESCRIPTION
 Ylo Rimless wall-mounted wc pan
 Seat & cover
 Soft close seat & cover

INC VAT **TVA INC**
 £547.82 734.08€
 £124.77 167.20€
 £166.37 222.93€

Total with wc and soft close seat
 Available cisterns p.128

£714.19 **957.01€**

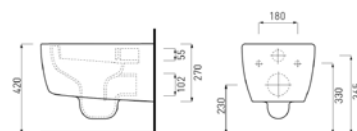



CODE
06013
06014
06121

DESCRIPTION
 Ylo short projection close-coupled WC
 Ylo cistern
 Ylo Thermal Slim soft close Seat & Cover

Total with cistern and soft close seat

INC VAT **TVA INC**
 £420.51 563.48€
 £192.60 258.08€
 £237.54 318.30€

£850.65 **1139.86€**

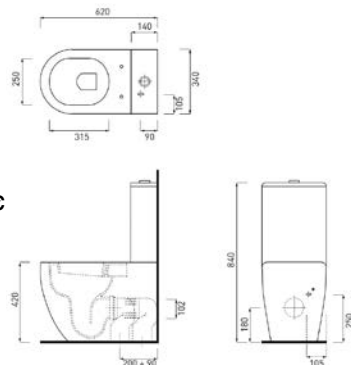

CODE
06015
06119
06120

DESCRIPTION
 Ylo short projection back-to-wall pan with floor outlet
 Seat & cover
 Soft close seat & cover

Total with wc and soft close seat

Available cisterns p.128

INC VAT **TVA INC**
 £346.05 463.70€
 £124.77 167.20€
 £166.37 222.93€

£512.42 **686.63€**

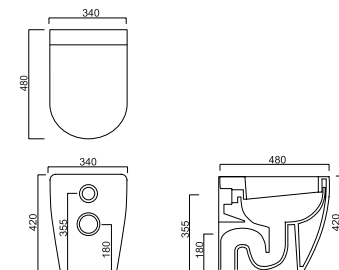

CODE
06021
06119
06120

DESCRIPTION
 Ylo short projection back-to-wall pan with wall outlet
 Seat & cover
 Soft close seat & cover

Total with wc and soft close seat

Available cisterns p.128

INC VAT **TVA INC**
 £346.05 463.70€
 £124.77 167.20€
 £166.37 222.93€

£637.19 **853.83€**

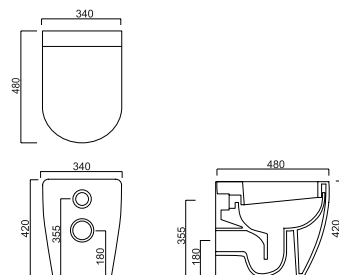

CODE
06016

DESCRIPTION
 Ylo short projection back-to-wall bidet

INC VAT **TVA INC**
 £427.79 573.24€

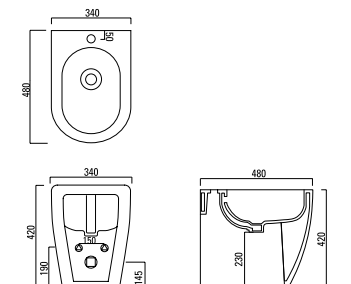

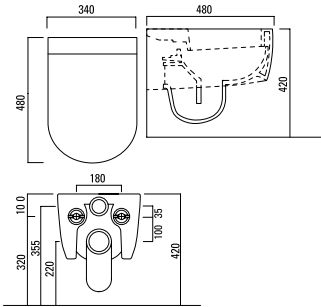

CODE
06017
06119
06120

DESCRIPTION
 Ylo short projection wall-mounted wc pan
 Seat & cover
 Soft close seat & cover

Total with wc and soft close seat
 Available cisterns p.128

INC VAT	TVA INC
£473.66	634.71€
£124.77	167.20€
£166.37	222.93€

£640.03	857.64€
----------------	----------------

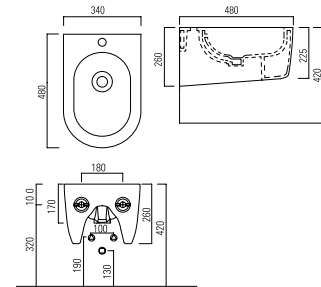

CODE
06018

DESCRIPTION
 Ylo short projection wall-mounted bidet

INC VAT	TVA INC
£427.79	573.24€



CODE
06120
06119

DESCRIPTION
 Soft close wc seat & cover
 Seat & cover

INC VAT	TVA INC
£166.37	222.93€
£124.77	167.20€



FLUSHE FLUSHING SYSTEMS



Pictured: Indigo 70116 wall-hung WC pan with matching bidet including Cos C0006 bidet mixer. Also featured, Indigo 70003 100cm washbasin with matching 1-drawer unit in gloss white and Steel slider shower enclosure.



CODE
FL4044

DESCRIPTION
FLUSHE 820mm universal framed cistern – either front
flush or top flush - MECHANICAL FLUSH

INC VAT
£259.00

TVA INC
347.06€

Formally - "FL4040"

Corresponding flush plates on opposite page

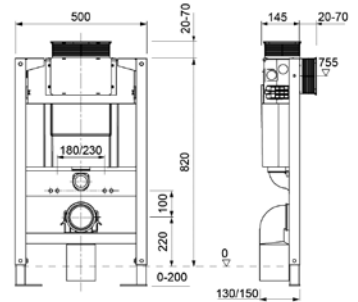

CODE
HC1038

DESCRIPTION
FLUSHE concealed cistern for use with flush plate.
(front & top operation) For reduced height installation -
MECHANICAL FLUSH

INC VAT
£185.00

TVA INC
247.90€

Formally - "HC1037"

Corresponding flush plates on opposite page

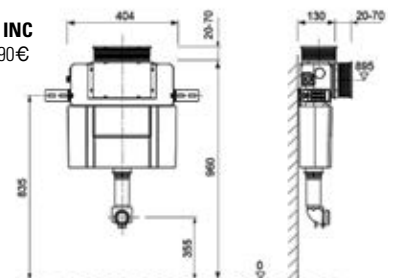

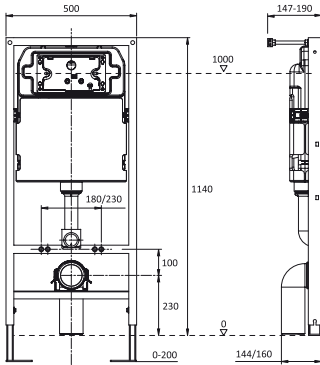

CODE
FL4042

DESCRIPTION
FLUSHE 1140mm universal framed cistern – front flush

INC VAT £267.00
TVA INC 357.78€

Corresponding flush plates on next page

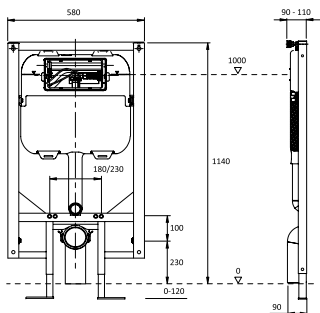

CODE
FL6062

DESCRIPTION
FLUSHE ultra-slim 80mm/1140mm universal framed cistern

INC VAT £335.00
TVA INC 448.90€

Corresponding flush plates on next page

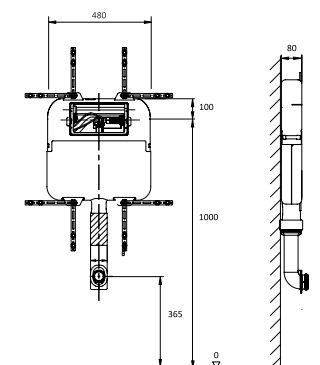

CODE
HC1036

DESCRIPTION
FLUSHE ultra-slim concealed cistern 80mm

INC VAT £187.00
TVA INC 250.58€

Corresponding flush plates on next page





CODE
FP031

DESCRIPTION

FLUSHE white dot flush plate
for cistern FL4044, HC1038, FL4042, FL6062 and HC1036.

INC VAT
£45.00

TVA INC
60.30€

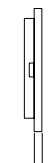
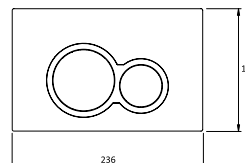

FP032

FLUSHE chrome dot flush plate
for cistern FL4044, HC1038, FL4042, FL6062 and HC1036.

£58.00

77.72€



FP033

FLUSHE black dot flush plate for
for cistern FL4044, HC1038, FL4042, FL6062 and HC1036.

£58.00

77.72€



FP034

FLUSHE white square flush plate
for cistern FL4044, HC1038, FL4042, FL6062 and HC1036.

£45.00

60.30€

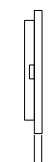
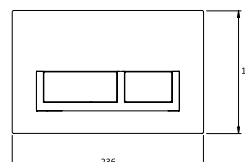

FP035

FLUSHE chrome square flush plate
for cistern FL4044, HC1038, FL4042, FL6062 and HC1036.

£58.00

77.72€



FP036

FLUSHE black square flush plate
for cistern FL4044, HC1038, FL4042, FL6062 and HC1036.

£58.00

77.72€



FP037

FLUSHE stainless steel dot flush plate
for cistern FL4044, HC1038, FL4042, FL6062 and HC1036

£100.00

134.00€



FP038

FLUSHE polished stainless steel dot plate
for cistern FL4044, HC1038, FL4042, FL6062 and HC1036

£135.00

180.90€

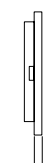
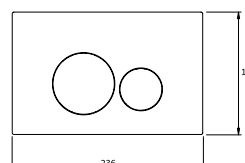

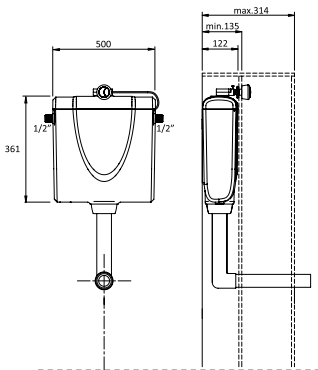

CODE
HC1030

DESCRIPTION
Slimline dual flush concealed cistern
left or right water entry.

Includes chrome dual flush button

Water saving dual flush cistern

INC VAT **TVA INC**
£105.00 140.70€

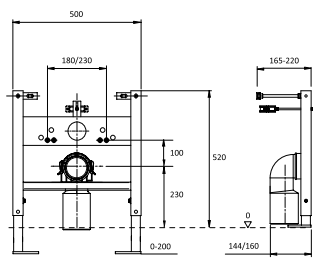

CODE
FL5052

DESCRIPTION
FLUSHE universal frame for wall-hung WC & bidet

INC VAT **TVA INC**
£152.00 203.68€



CODE
DR001
2008122

DESCRIPTION
SP straight outlet for FLUSHE framed cisterns
90/110mm adapter

INC VAT **TVA INC**
£23.53 31.53€
£15.74 21.09€

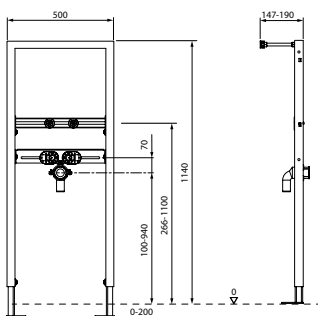

CODE
WF3030

DESCRIPTION
FLUSHE washbasin frame

INC VAT **TVA INC**
£145.04 194.36€



Need help specifying
your shower valve?...
Call free 0800 1973 800

WOW!

SIMPLICITY THAT RULES WATER

This is your chance to personalise your bathroom with Saneux brassware, which combines the best in engineering and technology with real creativity.

Much of our brassware featured uses the revolutionary Ceramix system, which improves performance of traditional ceramic discs, offering smoothness of movement.

Water pressures

Most of our brassware is to be installed with high pressure water systems. This would mean operating pressures should be a minimum of 1 bar (33ft head). Look for description shown below if selecting your taps with a low pressure system. Ask your plumber to explain this further if you are unsure what water system you have.

LA SIMPLICITÉ RÈGNE SUR L'EAU

C'est l'occasion rêvée de personnaliser votre salle de bains grâce à la robinetterie Saneux, qui associe créativité et le meilleur de l'ingénierie et de la technologie.

Nombre de nos éléments de robinetterie utilisent le système révolutionnaire Ceramix, qui améliore les performances des disques en céramique traditionnels et assure ainsi un mouvement tout en douceur.

Pression de l'eau La plupart de nos éléments de robinetterie doivent être installés avec des systèmes à haute pression. En d'autres termes, la pression de fonctionnement doit être au minimum de 1 bar (charge hydraulique de 10 mètres). Lisez le descriptif ci-dessous si vous optez pour des robinets avec un système à basse pression. En cas de doute quant à votre système d'eau et pour plus de détails, veuillez contacter votre plombier.

Vous ne savez pas quel
mitigeur de douche
choisir ?...

Appelez gratuitement le
0800 1973 800.

WOW!



'It's so satisfying installing Saneux taps, they are simple to use and smooth to operate'

Bathroom installer
Romford, Essex RM7

« C'est tellement plaisant d'installer des robinets Saneux, dont l'utilisation et le fonctionnement sont on ne peut plus simples. »

Un installateur de salles de bains, Romford, Essex RM7

Pictured: COS C0002 basin mixer monoblock.
Featured: AUSTEN 60cm basin with matching
1-drawer gloss white unit.

WATER SYSTEMS

To help you select the optimum brassware for your project we have marked our products with the pressure requirement. This is represented as follows:

LP – minimum 0.2 bar

MP – minimum 0.5 bar

HP – minimum 1.0 bar

Fig.1

Cold water is stored in a header tank which feeds the hot water tank, and usually the cold water to the bathroom. This means the water is delivered at low pressure and therefore only taps with LP or minimum 0.2Bar (2 metre Head) can be used. If the header tank is in the loft space and the taps are on the ground floor the pressure may be higher so taps marked MP 0.5 bar (5 meter head) may be able to be used. You will need to check your requirements with your plumber as, if a power shower is required a pump will need to be fitted.

Figure 1
Standard Low Pressure System

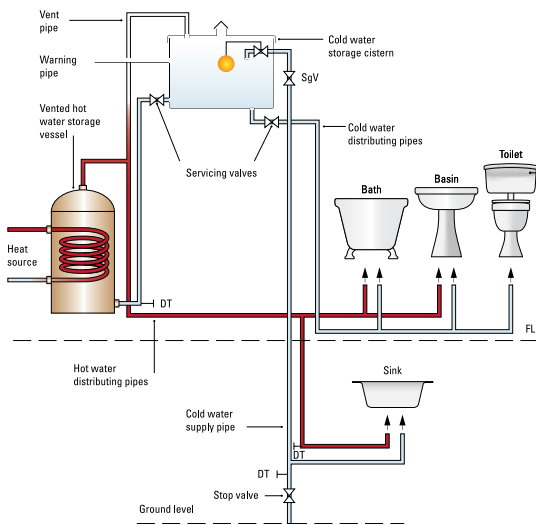
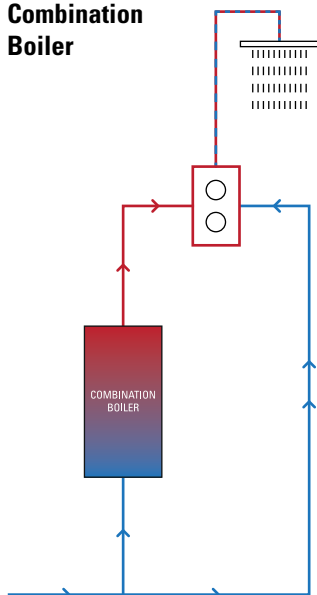

Figure 3
Combination Boiler



A combination Boiler heats water on demand, and although it is fed by mains pressure this is regulated to the speed which the boiler can heat the water.

All LP and MP taps and fittings may be used.

These are given as a guide only and to ensure optimum compatibility please refer to a qualified plumber and full product specifications.

Fig.2

The unvented cylinder stores hot water at mains pressure, usually between 2 and 3 bar. This means hot and cold water is delivered at the same pressure. This means a power shower can be achieved without the need for a pump. All LP, MP and HP taps and fittings may be used.

Figure 2
Unvented Pressure System

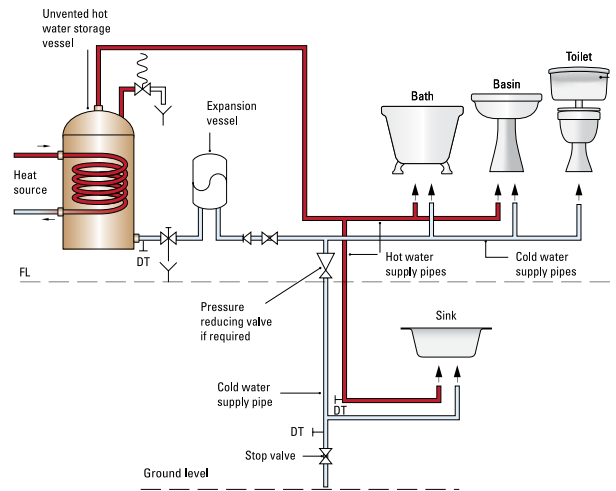
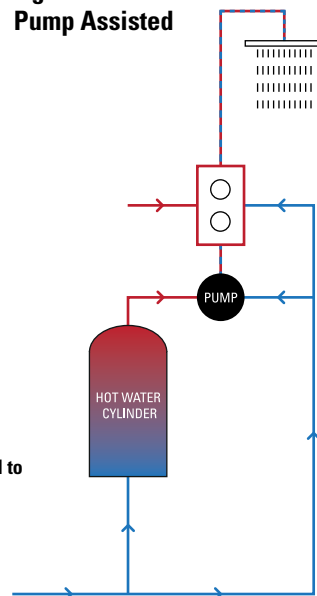

Figure 4
Pump Assisted



A pump assisted system will deliver water at high pressure and depending on the specifications of the pump fitted LP, MP and HP taps and fittings may be used.

SHOWER VALVE COMBINATIONS

To make your life easier we have four simple reference diagrams which make choosing a shower/bath/hand spray combination nice and easy

Concealed Thermo Valve 2 Way

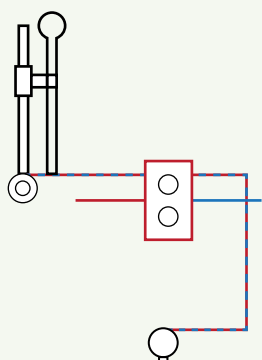

Figure 1

- Outlet 1** Bath filler
- Outlet 2** Slide rail kit

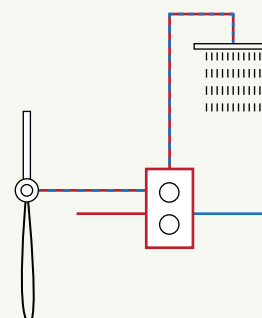

Figure 2

- Outlet 1** Overhead shower
- Outlet 2** Handspray

Concealed Thermo Valve 3 Way

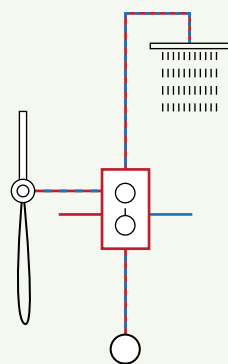

Figure 3

- Outlet 1** Overhead shower
- Outlet 2** Handspray
- Outlet 3** Bath filler

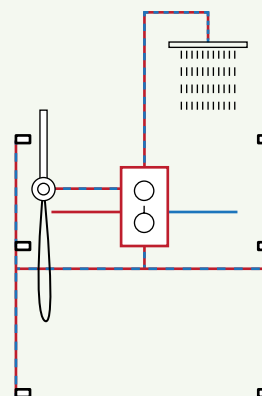

Figure 4

- Outlet 1** Overhead shower
- Outlet 2** Handspray
- Outlet 3** 6 x Body jets

SYSTÈMES D'EAU

Pour vous aider à choisir la robinetterie la mieux adaptée à votre projet, la valeur de pression requise est indiquée sur nos produits, et ce, comme suit :

LP (faible pression) : pression minimale de 0,2 bar
 MP (moyenne pression) : pression minimale de 0,5 bar
 HP (haute pression) : pression minimale de 1,0 bar

Fig.1

L'eau froide est stockée dans une nourrice qui alimente le chauffe-eau, mais également la salle de bains en eau froide. L'eau est alimentée à faible pression. C'est la raison pour laquelle seuls des robinets LP 0,2 bar (charge hydraulique de 2 mètres) peuvent être utilisés. Si la nourrice se trouve dans les combles et que les robinets se situent au rez-de-chaussée, la pression peut être plus élevée. Il est alors possible d'utiliser des robinets MP 0,5 bar (charge hydraulique de 5 mètres). Il convient de vérifier tout cela avec votre plombier, car si vous souhaitez installer une douche à hydromassage, une pompe devra également être installée.

Figure 1
Système à basse pression standard

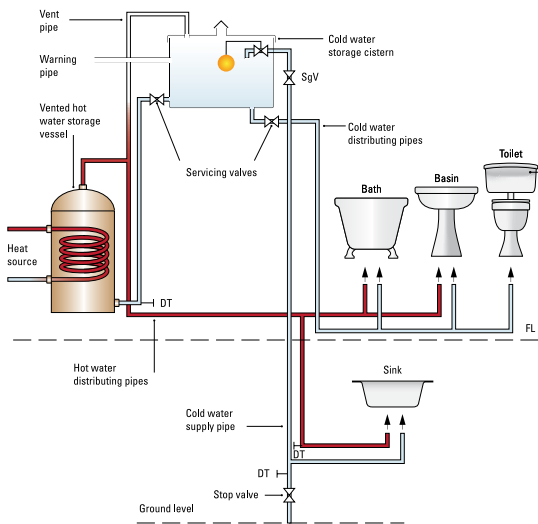
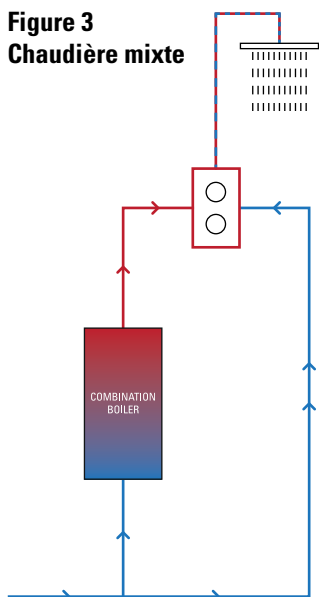

Figure 3
Chaudière mixte



Une chaudière mixte chauffe l'eau sur demande. Bien qu'elle soit alimentée par la pression du réseau, elle se règle en fonction de la vitesse à laquelle la chaudière peut chauffer l'eau.

Il est possible d'utiliser l'ensemble des raccords et robinets LP et MP.

Ces informations sont fournies à titre indicatif uniquement. Pour garantir la meilleure compatibilité possible, veuillez vous adresser à un plombier qualifié et consulter les caractéristiques des produits.

Fig.2

Le ballon non ventilé stocke l'eau chaude à la pression du réseau, généralement entre 2 et 3 bar. Cela signifie que l'eau (chaude et froide) est alimentée à la même pression. Ainsi, l'installation d'une douche à hydromassage ne requiert aucune pompe. Il est possible d'utiliser l'ensemble des raccords et robinets LP, MP et HP.

Figure 2
Système de pression non ventilé

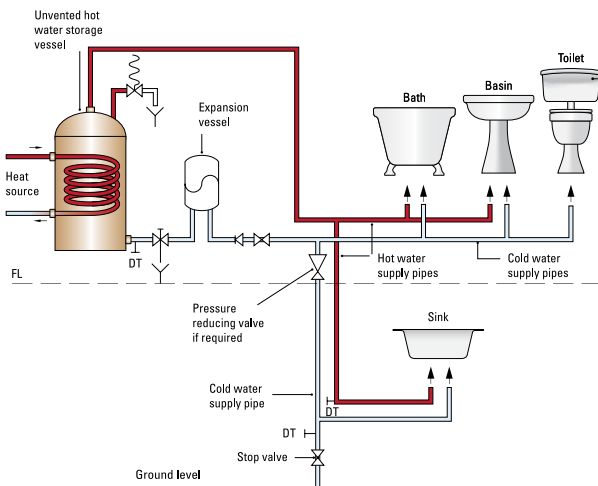
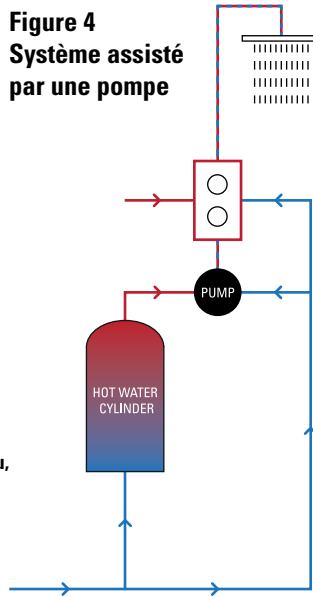

Figure 4
Système assisté par une pompe



Un système assisté par une pompe alimente l'eau à haute pression et en fonction des caractéristiques de la pompe installée, il est possible d'utiliser les raccords et robinets LP, MP et HP.

COMBINAISONS DE MITIGEURS DE DOUCHE

Dans l'objectif de vous simplifier la vie et de vous permettre de choisir facilement une combinaison pomme de douche/douchette de baignoire/douchette à main, nous avons élaboré quatre schémas de référence.

Mitigeur thermostatique encastré deux voies

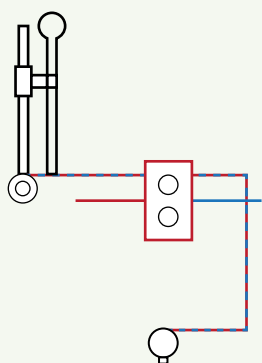

Figure 1

Sortie 1 Système de remplissage de baignoire

Sortie 2 Colonne de douche

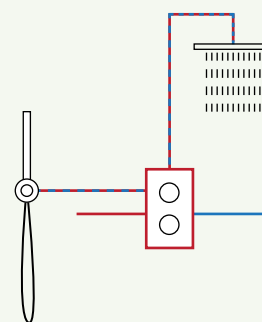

Figure 2

Sortie 1 Pomme haute

Sortie 2 Douchette à main

Mitigeur thermostatique encastré trois voies

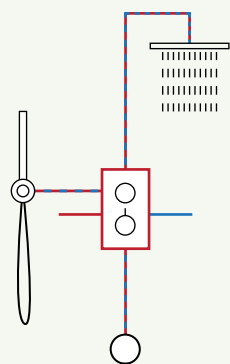

Figure 3

Sortie 1 Pomme haute

Sortie 2 Douchette à main

Sortie 3 Système de remplissage de baignoire

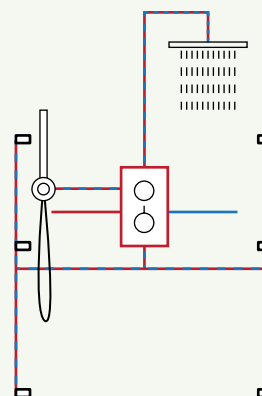

Figure 4

Sortie 1 Pomme haute

Sortie 2 Douchette à main

Sortie 3 6 buses hydromassantes

What a selection...

Tooga has been designed for the UK market with both bath and shower options to suit the fussiest. Don't you just LOVE the wall-mounted basin mixer with the lever to the side?

WOW!

Quel choix !...

Adaptée à la fois aux baignoires et aux douches, la gamme Tooga a été conçue pour le marché britannique et doit répondre aux besoins les plus exigeants. N'AI-MEZ-vous pas le mitigeur de lavabo mural avec son levier positionné sur le côté ?

WOW!

TOOGA

an imaginative focal point for any bathroom, this cute purist form will wow the squarest of them all

Point focal créatif de toute salle de bains, cette gamme aux lignes puristes va en surprendre plus d'un.



Pictured: Tooga T0002 basin mixer.

LP = 0.2 Bar

MP = 0.5 Bar

HP = 1.0 Bar

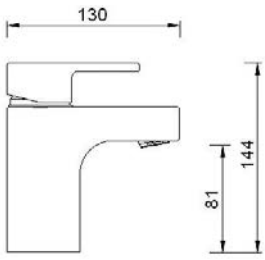

**CODE
TO001**

DESCRIPTION
Small washbasin mixer no popup waste - LP

INC VAT £175.48
TVA INC 235.15€

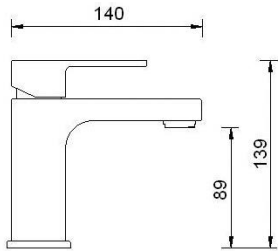

**CODE
TO002**

DESCRIPTION
Washbasin mixer no popup waste - MP

INC VAT £196.10
TVA INC 262.78€

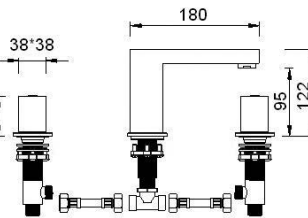

**CODE
TO003**

DESCRIPTION
Deck mounted 3 hole basin mixer no popup waste - LP

INC VAT £308.62
TVA INC 413.55€

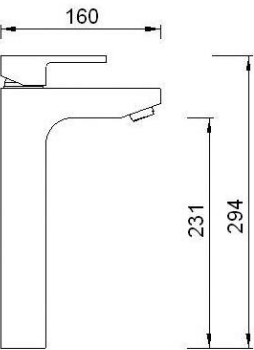

**CODE
TO004**

DESCRIPTION
Double height basin mixer no popup waste - MP

INC VAT £242.07
TVA INC 324.37€

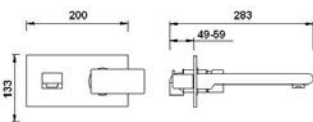

**CODE
TO005**

DESCRIPTION
Wall mounted basin mixer - MP

INC VAT £254.16
TVA INC 340.57€

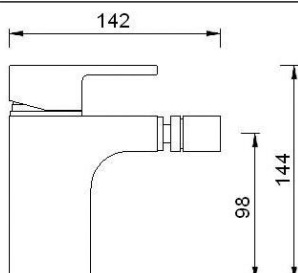

**CODE
TO006**

DESCRIPTION
Bidet mixer no popup waste - MP

INC VAT £175.48
TVA INC 235.15€



Tooga

LP = 0.2 Bar

MP = 0.5 Bar

HP = 1.0 Bar



CODE
T0013

DESCRIPTION
Deck mounted 4 hole bath shower mixer - MP

INC VAT
£447.80

TVA INC
600.05€

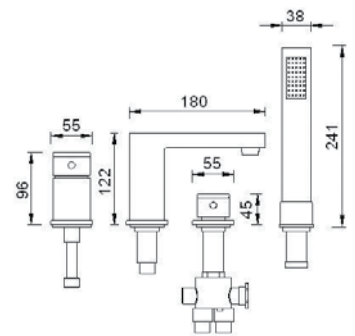

CODE
T0012

DESCRIPTION
Deck mounted bath filler – low pressure - LP

INC VAT
£296.53

TVA INC
397.35€

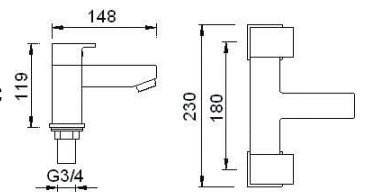

CODE
T0015

DESCRIPTION
Deck mounted bath shower filler – LP
Includes hose, handset & bracket

INC VAT
£361.88

TVA INC
484.92€

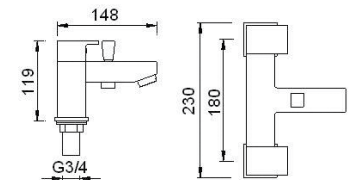

CODE
T0010

DESCRIPTION
Concealed manual shower valve - MP

INC VAT
£163.39

TVA INC
218.94€

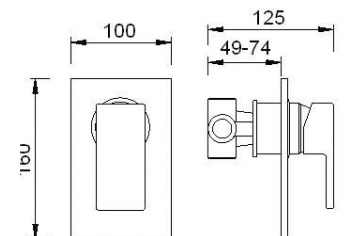

CODE
T0011

DESCRIPTION
Concealed manual bath shower mixer
including diverter - MP

INC VAT
£229.95

TVA INC
308.13€

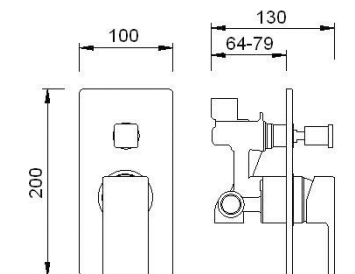

CODE
T0019

DESCRIPTION
One way thermostatic shower valve - LP

INC VAT
£423.60

TVA INC
567.63€

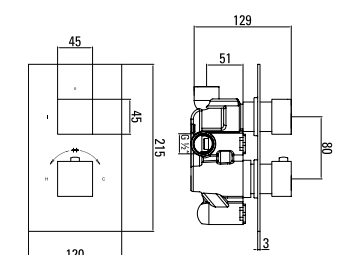

LP = 0.2 Bar

MP = 0.5 Bar

HP = 1.0 Bar

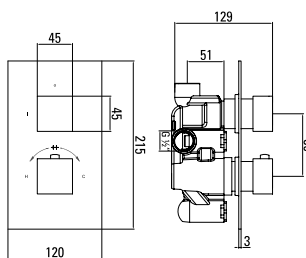

CODE
TO020

DESCRIPTION
Two way thermostatic shower valve - LP

INC VAT £447.80
TVA INC 600.05€

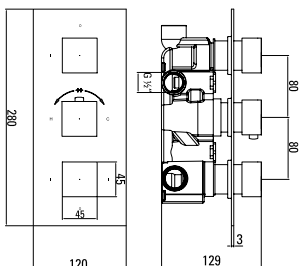

CODE
TO022

DESCRIPTION
Two way thermostatic shower valve - LP
with two stopcocks
(High flow)

INC VAT £470.81
TVA INC 630.88€

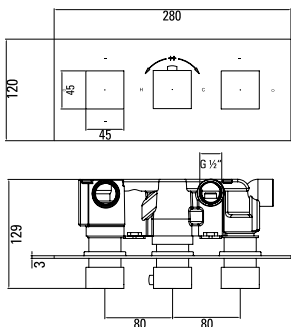

CODE
TO022.L

DESCRIPTION
Two way thermostatic shower valve - LP
with two stopcocks – landscape
(High flow)

INC VAT £470.81
TVA INC 630.88€

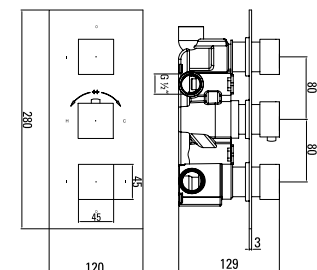

CODE
TO021

DESCRIPTION
Three way thermostatic shower valve - LP

INC VAT £502.22
TVA INC 672.98€

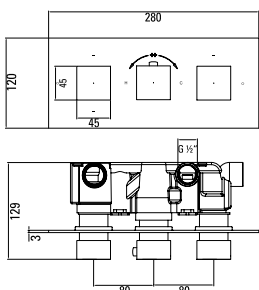

CODE
TO021.L

DESCRIPTION
Three way thermostatic shower valve - LP
– landscape

INC VAT £502.22
TVA INC 672.98€

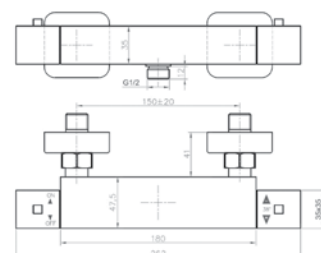

CODE
TO038

DESCRIPTION
Square exposed thermostatic shower valve - MP
(35mm) bottom outlet

INC VAT £119.78
TVA INC 160.50€



Tooga

LP = 0.2 Bar

MP = 0.5 Bar

HP = 1.0 Bar



CODE
T0035

DESCRIPTION
Thermostatic rigid riser – MP
inc. overhead & handset

INC VAT
£398.18

TVA INC
533.57€

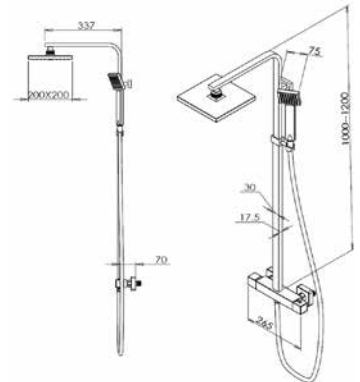

CODE
T0100

DESCRIPTION
Square bath filler with clicker wate and overflow

INC VAT
£119.78

TVA INC
160.50€

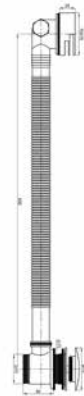

CODE
T0016

DESCRIPTION
Pull out handspray

INC VAT
£119.78

TVA INC
160.51€



Pictured: Tooga 3 hole basin mixer TO003.

MERCURY

MERCURY



Pictured: Mercury ME014 flat handle deck mounted BSM.

LP = 0.2 Bar

MP = 0.5 Bar

HP = 1.0 Bar

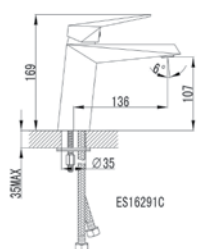

CODE
ME001

DESCRIPTION
Single basin mixer tap - MP

INC VAT £195.61
TVA INC 262.11€

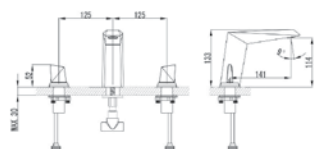

CODE
ME003

DESCRIPTION
3-hole lever handle basin mixer tap - MP

INC VAT £285.23
TVA INC 382.21€

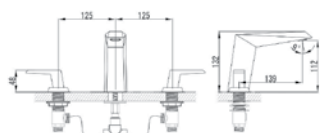
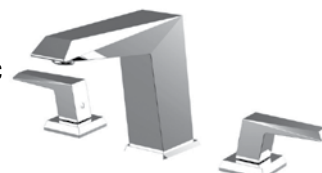

CODE
ME004

DESCRIPTION
3-hole flat turn handle basin mixer tap - MP

INC VAT £285.23
TVA INC 382.21€

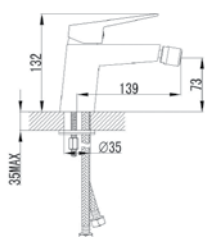

CODE
ME006

DESCRIPTION
Bidet mixer no pop-up - MP

INC VAT £212.32
TVA INC 285.85€

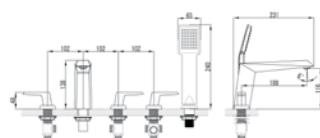

CODE
ME013

DESCRIPTION
Bsm lever handle deck mounted - HP

INC VAT £380.84
TVA INC 510.33€

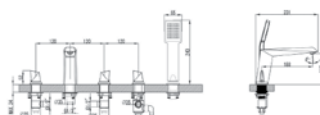

CODE
ME014

DESCRIPTION
Bsm flat turn handle deck mounted - HP

INC VAT £380.84
TVA INC 510.33€

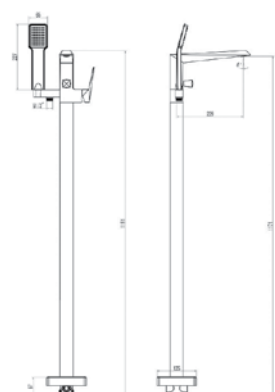

CODE
ME015

DESCRIPTION
Floor standing bath shower mixer - HP

INC VAT £628.30
TVA INC 841.93€



NICHOLSON

NICHOLSON



Pictured: NICHOLSON NI101 basin mixer tap & Podium 39009 sit-on washbasin.

LP = 0.2 Bar

MP = 0.5 Bar

HP = 1.0 Bar

NICHOLSON

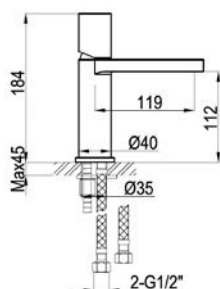

CODE
NI101

DESCRIPTION
Single lever basin mixer - MP

INC VAT £201.19
TVA INC 269.60€

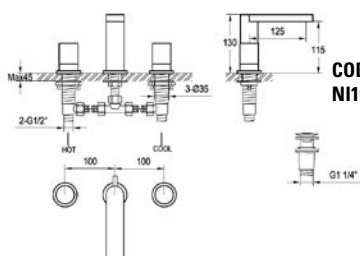

CODE
NI103

DESCRIPTION
3-hole basin mixer - MP

INC VAT £243.22
TVA INC 325.91€

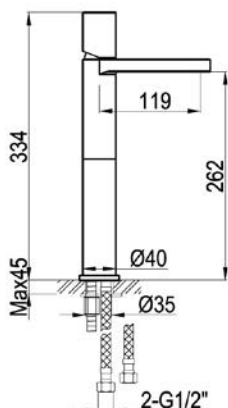

CODE
NI104

DESCRIPTION
Single lever high basin mixer - MP

INC VAT £233.23
TVA INC 312.52€

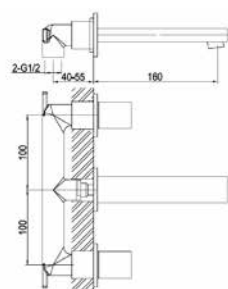

CODE
NI105

DESCRIPTION
Wall-mounted 2 Handle basin mixer - MP

INC VAT £243.22
TVA INC 325.91€

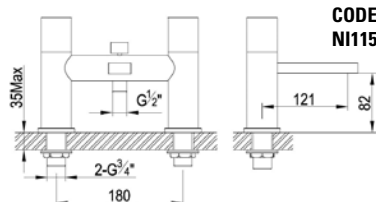

CODE
NI115

DESCRIPTION
Deck mounted bsm 2 handle - MP

INC VAT £309.34
TVA INC 414.52€



BELLE

Luxury without
a premium..

BELLE

It's the all in the details... Our stylish and elegant taps from our Belle range will never go unnoticed.

WOW!

Tout est dans le détail ! ... Les charmants robinets de notre gamme Belle ne passeront jamais inaperçus.

WOW!



BELLE

Pictured: Belle BE002 small basin mixer.

Belle

LP = 0.2 Bar

MP = 0.5 Bar

HP = 1.0 Bar



CODE
BE001

DESCRIPTION
Small basin mixer no popup waste - MP

INC VAT
£193.67

TVA INC
259.52€

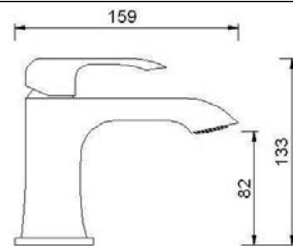

CODE
BE002

DESCRIPTION
Basin mixer no popup waste - MP

INC VAT
£206.46

TVA INC
276.65€

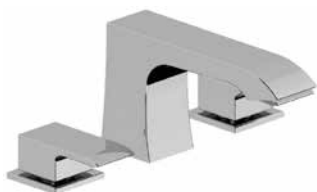
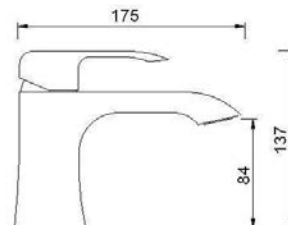

CODE
BE003

DESCRIPTION
Deck mounted 3 hole basin mixer - LP

INC VAT
£262.67

TVA INC
351.97€

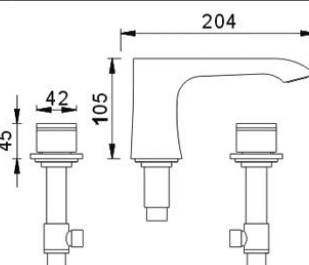

CODE
BE005

DESCRIPTION
Wall mounted basin mixer no popup waste - MP

INC VAT
£250.38

TVA INC
335.52€

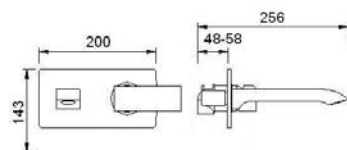

CODE
BE006

DESCRIPTION
Bidet mixer no popup waste - MP

INC VAT
£195.47

TVA INC
261.93€

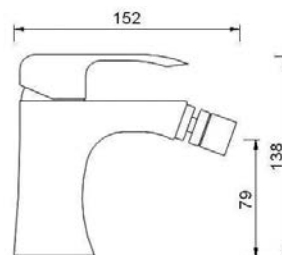

CODE
BE010

DESCRIPTION
Concealed manual shower valve - MP

INC VAT
£145.38

TVA INC
194.82€

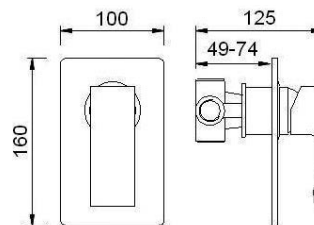

CODE
BE011

DESCRIPTION
Concealed manual bath shower mixer - MP including diverter

INC VAT
£238.24

TVA INC
319.24€

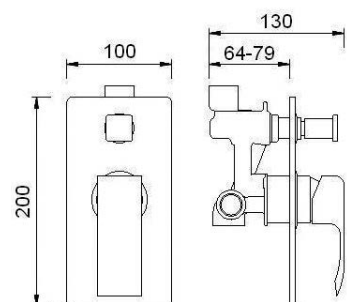

BELLE

LP = 0.2 Bar

MP = 0.5 Bar

HP = 1.0 Bar

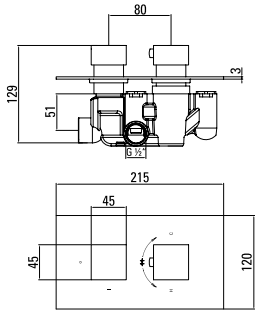

**CODE
T0019**

DESCRIPTION
One way thermostatic shower valve - LP

INC VAT £423.60
TVA INC 567.63€

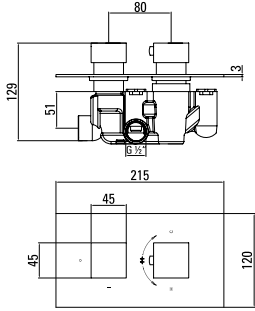

**CODE
T0020**

DESCRIPTION
Two way thermostatic shower valve - LP

INC VAT £447.80
TVA INC 600.05€

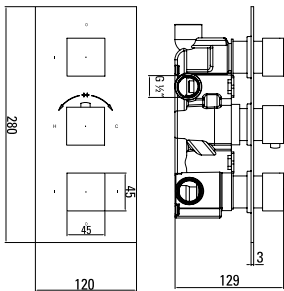

**CODE
T0022**

DESCRIPTION
Two way thermostatic shower valve - LP
with two stopcocks – landscape

INC VAT £470.81
TVA INC 630.88€

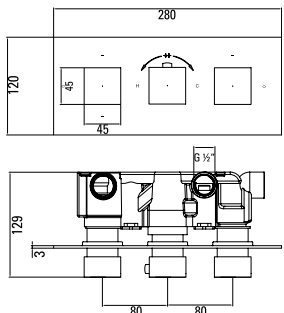

**CODE
T0022.L**

DESCRIPTION
Two way thermostatic shower valve - LP
with two stopcocks – landscape

INC VAT £470.81
TVA INC 630.88€

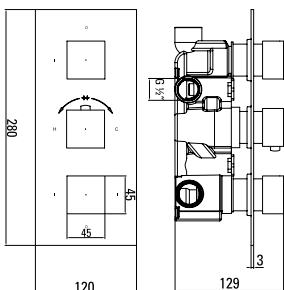

**CODE
T0021**

DESCRIPTION
Three way thermostatic shower valve - LP

INC VAT £502.22
TVA INC 672.98€

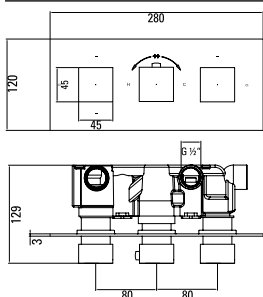

**CODE
T0021.L**

DESCRIPTION
Three way thermostatic shower valve - LP
landscape

INC VAT £502.22
TVA INC 672.98€



BELLE

Pictured: Pascale PA001 Basin mixer.

PASCALE



PASCALE

release your dream

Vivez vos rêves !

LP = 0.2 Bar

MP = 0.5 Bar

HP = 1.0 Bar



		<p>CODE PA001</p>	<p>DESCRIPTION Pascale basin mixer - LP including slotted clicker waste</p>	<p>INC VAT £104.67</p>	<p>TVA INC 140.26€</p>	
		<p>CODE PA004</p>	<p>DESCRIPTION Pascale tall basin monoblock - LP</p>	<p>INC VAT £127.02</p>	<p>TVA INC 170.20€</p>	
		<p>CODE PA006</p>	<p>DESCRIPTION Pascale bidet monoblock - LP</p>	<p>INC VAT £112.90</p>	<p>TVA INC 151.28€</p>	
		<p>CODE PA012</p>	<p>DESCRIPTION Pascale bath filler - LP</p>	<p>INC VAT £163.46</p>	<p>TVA INC 219.04€</p>	
		<p>CODE PA015</p>	<p>DESCRIPTION Pascale bath shower mixer - LP includes hose, handset and bracket</p>	<p>INC VAT £198.74</p>	<p>TVA INC 266.31€</p>	

Pascale . . .

LP = 0.2 Bar

MP = 0.5 Bar

HP = 1.0 Bar



CODE
PA003

DESCRIPTION
Pascale three hole basin mixer - LP

INC VAT £204.63
TVA INC 274.21€

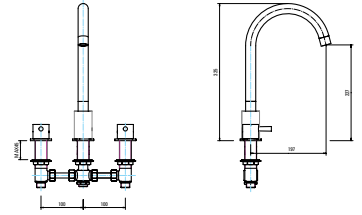

CODE
PA005

DESCRIPTION
Pascale three hole wall mounted mixer - MP

INC VAT £127.02
TVA INC 170.20€

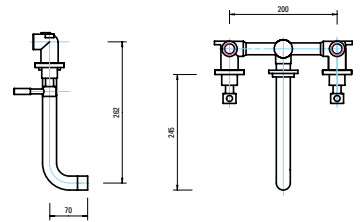

CODE
PA013

DESCRIPTION
Pascale four hole bath set - MP

INC VAT £268.14
TVA INC 359.30€

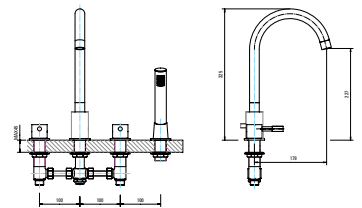

CODE
PA014

DESCRIPTION
Pascale three hole bath set - MP

INC VAT £204.63
TVA INC 274.21€

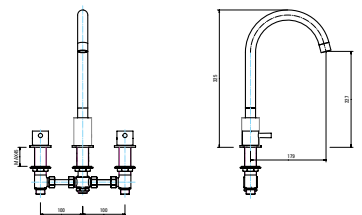

CODE
PA016

DESCRIPTION
Pascale three hole bath mixer

INC VAT £134.07
TVA INC 179.65€

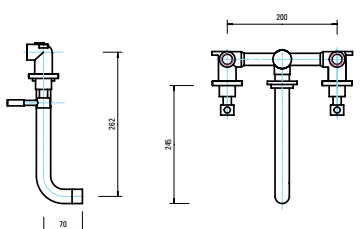

LP = 0.2 Bar

MP = 0.5 Bar

HP = 1.0 Bar

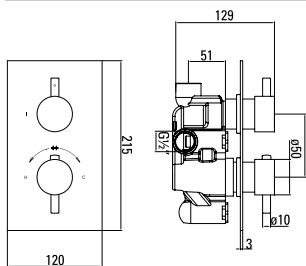

**CODE
C0019**

DESCRIPTION
One way thermostatic shower valve - LP

INC VAT £375.15
TVA INC 502.70€

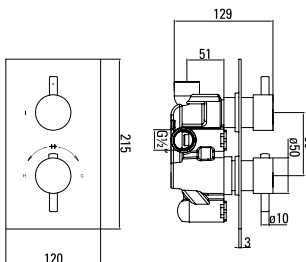

**CODE
C0020**

DESCRIPTION
Two way thermostatic shower valve - LP

INC VAT £410.43
TVA INC 549.97€

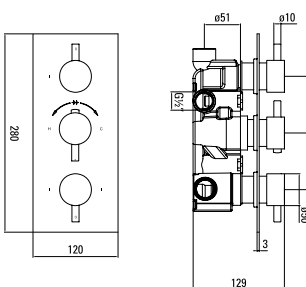

**CODE
C0022**

DESCRIPTION
Two way thermostatic shower valve - LP
with two stopcocks
(High flow)

INC VAT £457.48
TVA INC 613.02€

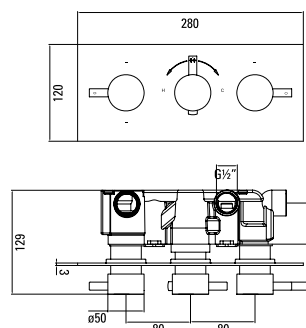

**CODE
C0022.L**

DESCRIPTION
Two way thermostatic shower valve - LP
with two stopcocks – landscape
(High flow)

INC VAT £457.48
TVA INC 613.02€

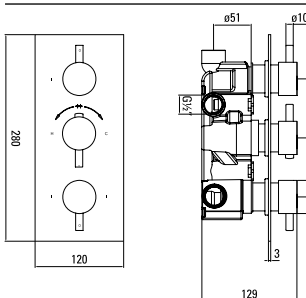

**CODE
C0021**

DESCRIPTION
Three way thermostatic shower valve - LP

INC VAT £469.24
TVA INC 628.79€

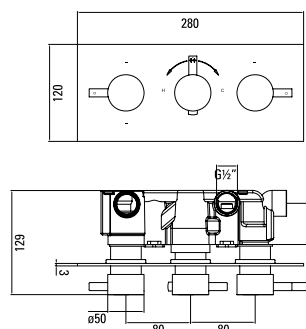

**CODE
C0021.L**

DESCRIPTION
Three way thermostatic shower valve - LP
with two stopcocks – landscape

INC VAT £469.24
TVA INC 628.79€



PASCALE



COS

Elegance
to enjoy...

For a lifetime use...

all of our taps are produced with the best materials to ensure longevity as well as a smooth and firm operation which maintains temperature with ease.

WOW!

Une utilisation à vie...

Tous nos robinets sont fabriqués à partir des meilleurs matériaux, et ce, afin de garantir leur longévité et leur bon fonctionnement. Rien de mieux pour régler la température souhaitée.

WOW!



LP = 0.2 Bar

MP = 0.5 Bar

HP = 1.0 Bar



CODE
CO001

DESCRIPTION
Basin mixer no popup waste - MP

INC VAT £151.30
TVA INC 202.74€

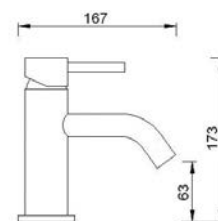

CODE
CO002

DESCRIPTION
Small basin mixer no popup waste - MP

INC VAT £151.30
TVA INC 202.74€

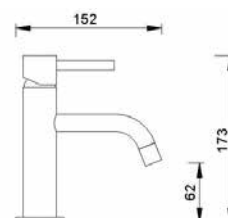

CODE
CO004

DESCRIPTION
Double height basin mixer - MP

INC VAT £223.91
TVA INC 300.03€

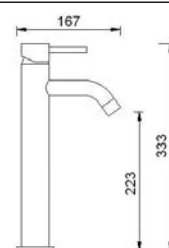

CODE
CO005

DESCRIPTION
Wall mounted basin mixer - MP

INC VAT £248.04
TVA INC 332.38€

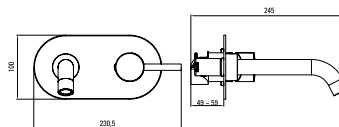

CODE
CO006

DESCRIPTION
Bidet mixer no popup waste - MP

INC VAT £121.02
TVA INC 162.17€

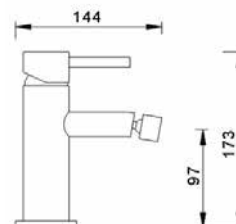

CODE
CO007

DESCRIPTION
Basin pillar taps - pair - LP

INC VAT £96.83
TVA INC 129.76€

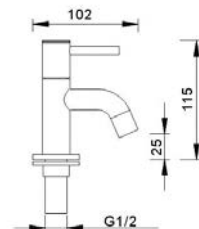

CODE
CO008

DESCRIPTION
Deck mounted bath pillar taps - pair - LP

INC VAT £151.30
TVA INC 202.74€

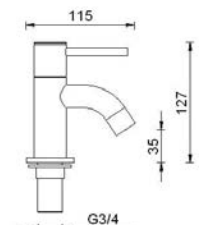

LP = 0.2 Bar

MP = 0.5 Bar

HP = 1.0 Bar

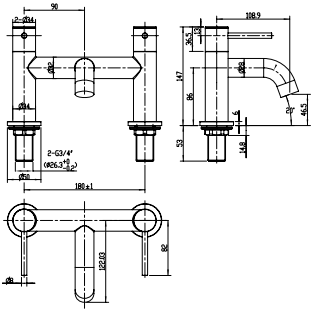

CODE
CO012

DESCRIPTION
Deck mounted bath filler - LP

INC VAT **TVA INC**
£192.44 257.86€

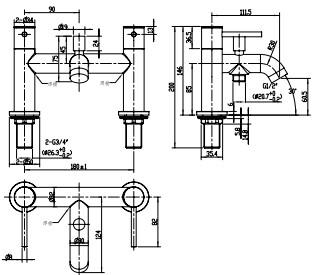

CODE
CO013

DESCRIPTION
Cos deck mounted bath/shower mixer - LP
inc. handset, hose and bracket

INC VAT **TVA INC**
£242.07 324.37€

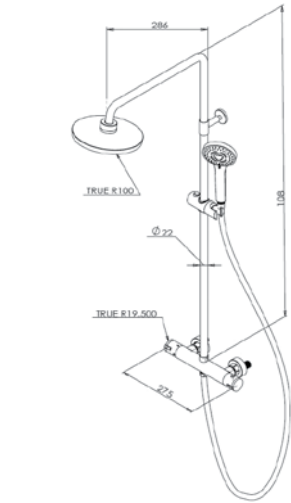

CODE
CO035

DESCRIPTION
Thermostatic rigid riser - MP
inc. overhead & handset

INC VAT **TVA INC**
£332.83 446.00€

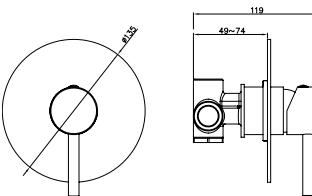

CODE
CO010

DESCRIPTION
Concealed manual bath shower mixer - MP

INC VAT **TVA INC**
£175.48 235.15€

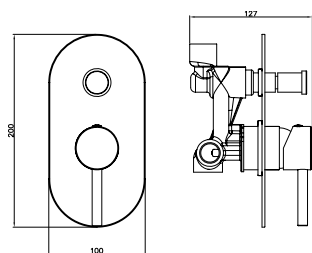

CODE
CO011

DESCRIPTION
Concealed manual shower valve - MP
inc. diverter

INC VAT **TVA INC**
£242.07 324.37€



LP = 0.2 Bar

MP = 0.5 Bar

HP = 1.0 Bar



CODE
C0019

DESCRIPTION
One way thermostatic shower valve - LP

INC VAT £386.08
TVA INC 517.34€

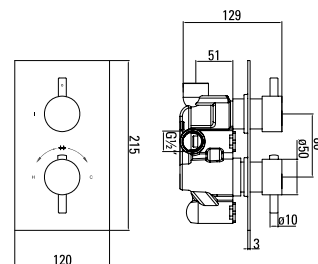

CODE
C0020

DESCRIPTION
Two way thermostatic shower valve - LP

INC VAT £422.38
TVA INC 565.99€

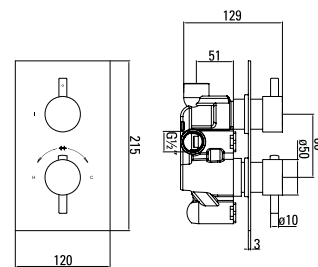

CODE
C0022

DESCRIPTION
Two way thermostatic shower valve - LP
with two stopcocks
(High flow)

INC VAT £470.81
TVA INC 630.88€

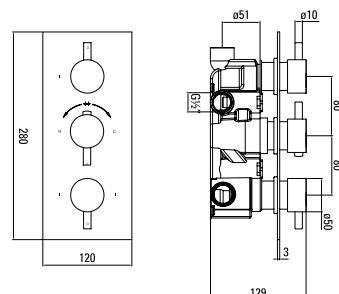

CODE
C0022.L

DESCRIPTION
Two way thermostatic shower valve - LP
with two stopcocks – landscape
(High flow)

INC VAT £470.81
TVA INC 630.88€

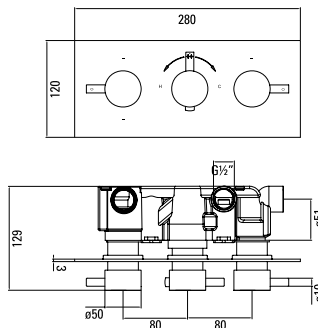

CODE
C0021

DESCRIPTION
Three way thermostatic shower valve - LP

INC VAT £482.91
TVA INC 647.10€

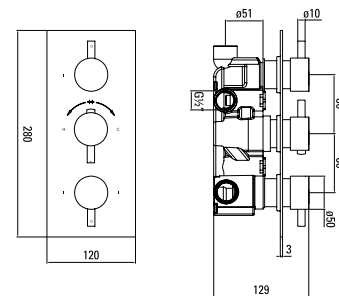

CODE
C0021.L

DESCRIPTION
Three way thermostatic shower valve - LP
with two stopcocks – landscape

INC VAT £482.91
TVA INC 647.10€

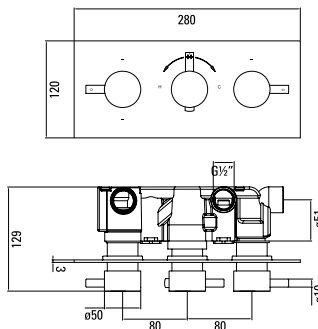

LP = 0.2 Bar

MP = 0.5 Bar

HP = 1.0 Bar

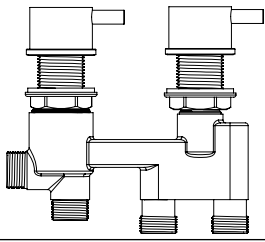

CODE
CO014

DESCRIPTION
2-way thermostatic deck-mounted bath valve - MP

INC VAT £321.93
TVA INC 431.39€

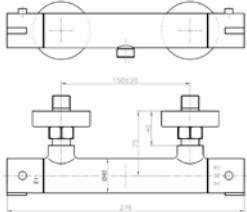

CODE
CO038

DESCRIPTION
Exposed round thermostatic shower valve - MP
(35mm), bottom outlet

INC VAT £102.82
TVA INC 137.78€

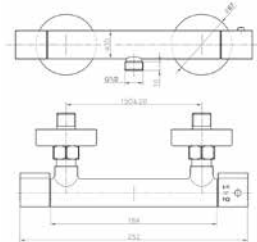

CODE
CO039

DESCRIPTION
Exposed round thermostatic shower valve - MP
(30mm), bottom outlet

INC VAT £94.34
TVA INC 126.42€

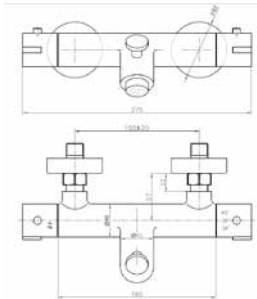

CODE
CO040

DESCRIPTION
Thermostatic bath shower mixer - MP

Also includes chrome legs for deck-mounted installation.

INC VAT £203.32
TVA INC 272.45€



CODE
CO100

DESCRIPTION
Round bath filler with clicker waste and overflow

INC VAT £107.71
TVA INC 144.33€



CODE
CO016

DESCRIPTION
Pull out handspray

INC VAT £119.78
TVA INC 160.51€



CODE
CO017

DESCRIPTION
Pull out handspray

INC VAT £119.78
TVA INC 160.51€



It's the finish that counts

... our taps are made of the smoothest brass coated in shiny hard chrome for a lasting durable finish

WOW!

C'est la finition qui compte...

Nos robinets sont fabriqués à partir du cuivre le plus lisse qui soit et recouverts d'une couche de chrome dur et brillant, pour une finition durable dans le temps.

WOW!

TEMPUS

TEMPUS

A graceful classic, perfect for your distinctive bathroom.

Un classique élégant, idéal pour votre salle de bains typique.

Pictured: Tempus TE420 3 hole basin mixer

LP = 0.2 Bar

MP = 0.5 Bar

HP = 1.0 Bar



CODE
TE814

DESCRIPTION
Deck-mounted bath filler - MP

INC VAT £536.48
TVA INC 718.88€

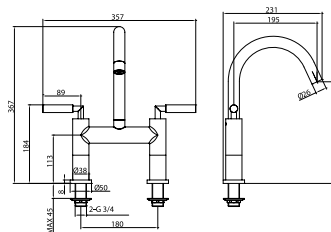

CODE
TE430

DESCRIPTION
3-hole wall-mounted bath mixer - MP

INC VAT £276.88
TVA INC 371.02€

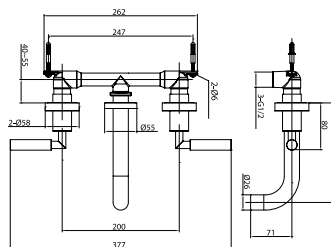

CODE
TE151

DESCRIPTION
Wall-mounted basin mixer – single plate - MP

INC VAT £363.41
TVA INC 486.97€

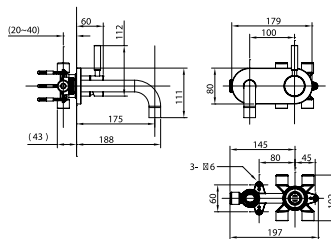

CODE
TE150

DESCRIPTION
Wall-mounted basin mixer - MP

INC VAT £363.41
TVA INC 486.97€

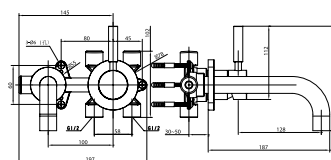

CODE
TE250

DESCRIPTION
Wall-mounted basin mixer with swivel spout - MP

INC VAT £386.49
TVA INC 517.90€

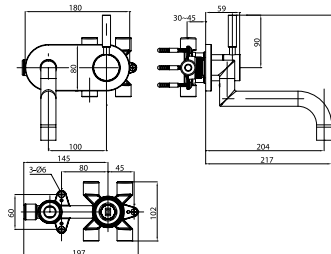

CODE
TE230

DESCRIPTION
Sink mixer - MP

INC VAT £276.88
TVA INC 371.02€

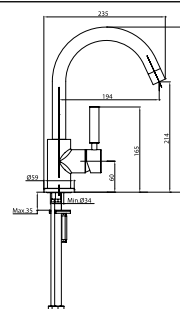

LP = 0.2 Bar

MP = 0.5 Bar

HP = 1.0 Bar

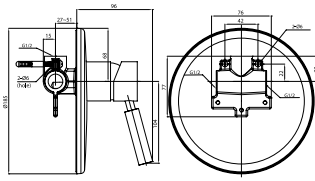

**CODE
TE370**

DESCRIPTION
Concealed manual shower valve - MP

INC VAT **TVA INC**
£167.28 224.16€

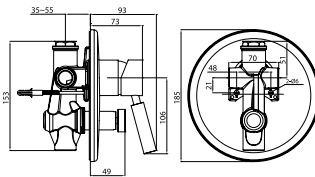

**CODE
TE320**

DESCRIPTION
Concealed manual shower valve - MP
inc. diverter

INC VAT **TVA INC**
£171.90 230.35€

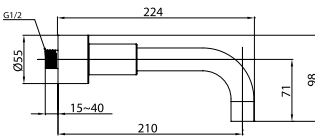

**CODE
TE800**

DESCRIPTION
Bath Spout

INC VAT **TVA INC**
£103.83 139.14€



TEMPUS

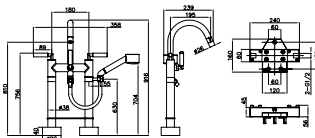

**CODE
TE820**

DESCRIPTION
Floor mounted BSM - MP

INC VAT **TVA INC**
£1096.02 1468.67€



EASY O



EASY O

Graceful and modern. The Easy O range has swivel spouts in all basin and bidet mixers, adding versatility and function.

Gracieuse et moderne. Tous les mitigeurs pour lavabos et bidets de la gamme Easy O sont dotés de becs pivotants, pour plus de souplesse et de fonctionnalité.

Pictured: Easy O E0001 basin mixer.

LP = 0.2 Bar

MP = 0.5 Bar

HP = 1.0 Bar

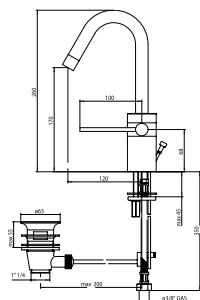

CODE
E0001

DESCRIPTION
Basin mixer with pop-up waste - HP

INC VAT £251.69
TVA INC 337.26€

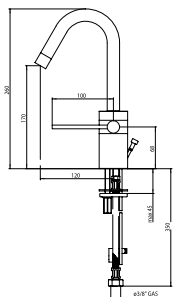

CODE
E0002

DESCRIPTION
Basin mixer no pop-up waste - HP

INC VAT £239.71
TVA INC 321.21€

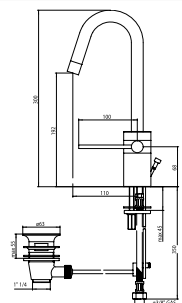

CODE
E0003

DESCRIPTION
Basin mixer with pop-up waste - HP
– high spout

INC VAT £275.67
TVA INC 369.39€

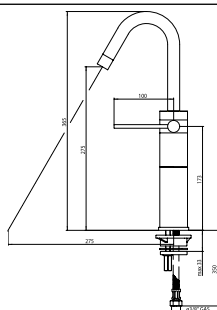

CODE
E0004

DESCRIPTION
High basin mixer - HP

INC VAT £323.59
TVA INC 433.62€

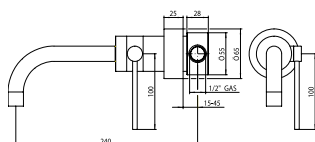

CODE
E0005

DESCRIPTION
Wall mounted basin mixer - HP

INC VAT £245.68
TVA INC 329.22€

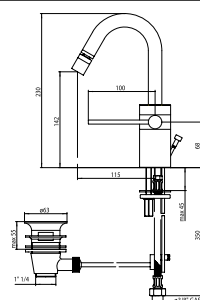

CODE
E0006

DESCRIPTION
Bidet mixer with pop-up waste - HP

INC VAT £275.67
TVA INC 369.39€



INSIDE



INSIDE

The INSIDE semi-recessed electric mirror combines minimalist design & cutting edge technology for a space-saving solution like never before. Just look inside..

Le miroir électrique semi-encastré INSIDE allie design minimaliste et technologie de pointe, offrant ainsi une solution plus que jamais compacte. Il vous suffit de regarder à travers.

Pictured: Inside IN001 mirror cabinet with Austen 50010 basin and matching unit. Also featured Pascale PA001 basin mixer.

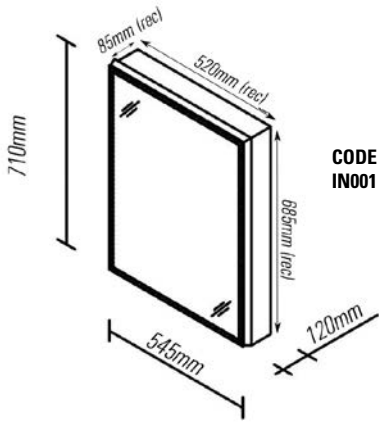

CODE
IN001

DESCRIPTION
Inside recessed mirror cabinet
LH hinge only

INC VAT
£497.56

TVA INC
666.73€

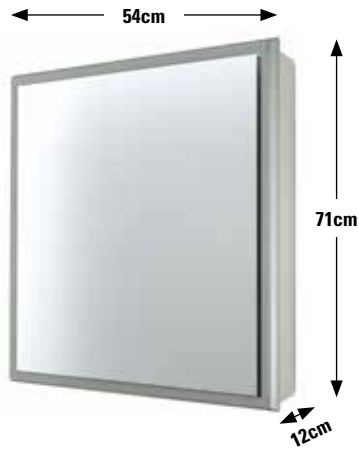

KEY FEATURES

- In-built demister pad
- Shaver socket
- LED light switch
- Energy efficient design
- IP44 rated product



Scan QR code for the video overview of the IN001

Pictured: INSIDE IN001 semi-recessed electric mirror with INDIGO basin and 1-drawer unit. Also featured, AUSTEN wall-hung WC, matching bidet and TEMPUS TE-7210 electric towel rails.



ICE MIRROR CABINETS

Stunning sleek bathroom cabinets constructed from aluminium giving any bathroom the real cutting edge. The doors are mirrored both sides and the glass shelves inside can be adjusted to suit yourself.

Des armoires aux lignes épurées, fabriquées à partir d'aluminium et qui placent la salle de bains à la pointe de l'innovation. Les portes sont dotées d'un miroir de chaque côté et les étagères intérieures en verre peuvent être réglées en fonction de vos besoins.

'we knew Ice would do well for us because of the small space it takes above basin! Plus the low running cost of LEDs are perfect for closing the sale'

Bathroom showroom
Coventry, West Mids

< Nous savions que le miroir nous conviendrait, et ce, en raison du peu de place qu'il prend au-dessus du lavabo ! En outre, le faible coût de fonctionnement de l'éclairage LED ne pouvait que valider notre choix. >

Dans un magasin de salles de bains, Coventry (West Midlands)

With a flick of a hand...
Our practical aluminium bathroom cabinets boast a sensor switch that is activated just with a wave of your hand. It also contains a shaver socket inside for your convenience.

D'un simple geste de la main...
Nos armoires en aluminium sont dotées d'un interrupteur à effleurement qui s'active d'un simple geste. Elles sont également équipées d'une prise rasoir.

WOW!

WOW!



ICE

Pictured: Ice 1075 75cm mirror cabinet.

Ice Mirror Cabinets

LED lights give a clean glow and are operated with a 'non touch' sensor

L'éclairage LED émet une lumière pure et fonctionne à l'aide d'un capteur « non tactile ».



CODE
1051

DESCRIPTION

Ice 50cm mirror cabinet including LED lights and shaver socket.

- Single door mirrored both sides
- Left hand hinge
- Aluminium carcass



INC VAT
£481.01

TVA INC
644.56€

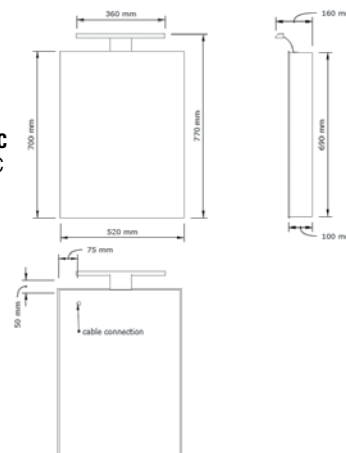

Important note: Touch sensor external switch cannot be fitted any less than 150mm from side wall



CODE
1051R

DESCRIPTION

Ice 50cm mirror cabinet including LED lights and shaver socket.

- Single door mirrored both sides
- Right hand hinge
- Aluminium carcass



INC VAT
£481.01

TVA INC
644.56€

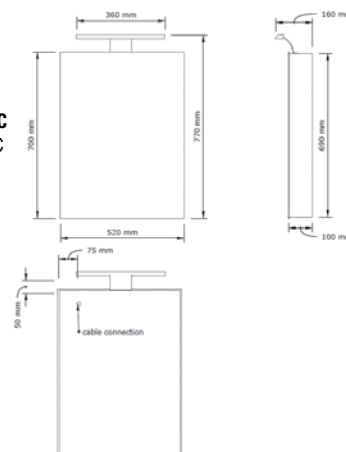

Important note: Touch sensor external switch cannot be fitted any less than 150mm from side wall



CODE
1061

DESCRIPTION

Ice 60cm mirror cabinet including LED lights and shaver socket.

- Double door mirrored both sides
- Aluminium carcass



INC VAT
£517.99

TVA INC
694.11€

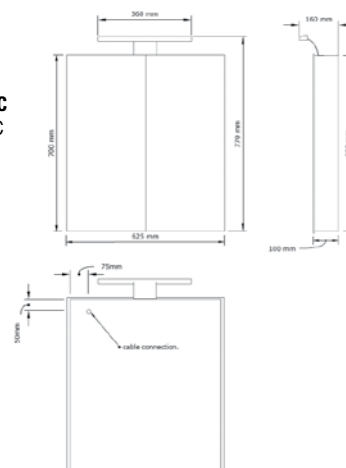

Important note: Touch sensor external switch cannot be fitted any less than 150mm from side wall

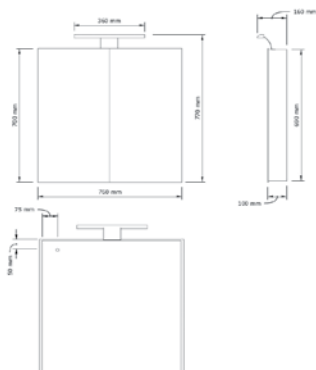

**CODE
1075**

DESCRIPTION
Ice 75cm mirror cabinet including LED lights
and shaver socket.

- Double door mirrored both sides
- Aluminium carcass



INC VAT **TVA INC**
£653.68 875.93€



Important note: Touch sensor external switch
cannot be fitted any less than 150mm from side wall

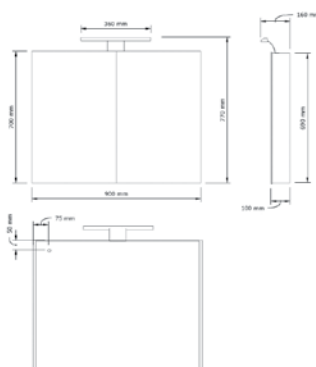

**CODE
1090**

DESCRIPTION
Ice 90cm mirror cabinet including LED lights
and shaver socket.

- Double door mirrored both sides
- Aluminium carcass



INC VAT **TVA INC**
£783.18 1049.47€



Important note: Touch sensor external switch
cannot be fitted any less than 150mm from side wall



**Discreet sensor switch
for 'no touch' operation**

Interrupteur à effleurement discret,
pour un fonctionnement non tactile



**Shaver socket located
at top of cabinet**

Prise rasoir située en haut de
l'armoire



**Multiple shelf
spacing options**

Étagères modulables



**Subtle LED lighting providing
ideal mood lighting at low cost**

Éclairage LED subtil offrant une
lumière d'ambiance à moindre coût

Ice Non Electric Mirror Cabinets



CODE
1052

DESCRIPTION
Ice 50cm mirror cabinet.
Single door mirrored both sides
Reversible for left or right hand opening

INC VAT
£345.34

TVA INC
462.75€

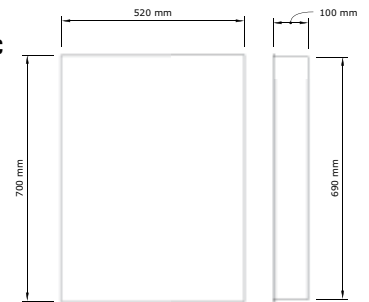

CODE
1062

DESCRIPTION
Ice 60cm mirror cabinet. 2 door mirrored both sides

INC VAT
£394.68

TVA INC
528.87€

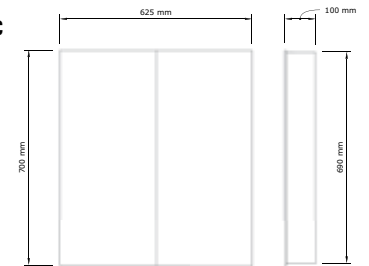

CODE
1076

DESCRIPTION
Ice 75cm mirror cabinet. 2 door mirrored both sides

INC VAT
£487.18

TVA INC
652.82€



CODE
1092

DESCRIPTION
Ice 90cm mirror cabinet. 2 door mirrored both sides

INC VAT
£610.51

TVA INC
818.09€

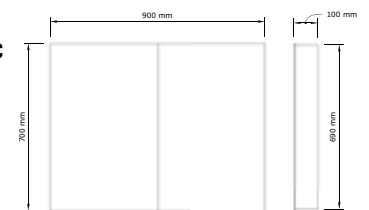

ELUMINATE MIRRORS

With a flick of a hand...
Our practical aluminium bathroom cabinets boast a sensor switch that is activated just with a wave of your hand. It also contains a shaver socket inside for your convenience.

WOW!



Pictured: Elluminate M1016 electric mirror.

D'un simple geste de la main... Nos armoires en aluminium sont dotées d'un interrupteur à effleurement qui s'active d'un simple geste. Elles sont également équipées d'une prise rasoir

WOW!

ELUMINATE

Illuminate Mirrors

Who is that?...
Your reflection is ours. Our cabinets and mirrors are built to last and the LED lighting will give a long life and are easy to replace

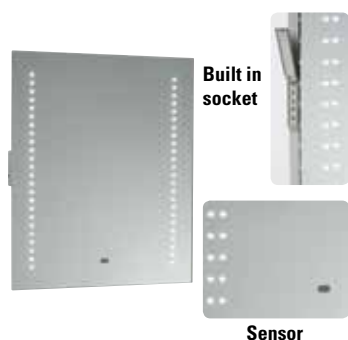

CODE
M1011

DESCRIPTION

TECHNICAL
Depth: 50mm
Height: 600mm
Width: 500mm
Lamp type: LED x 48
Lamp: Included
Switched: Sensor
Weight: 7.5Kg
Material: Mirror / Steel



INC VAT
£305.42

TVA INC
409.27€

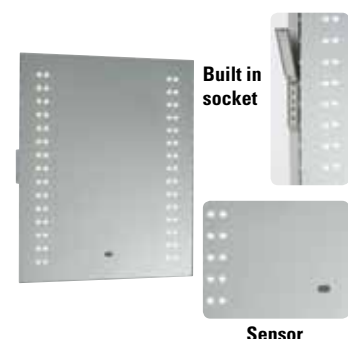
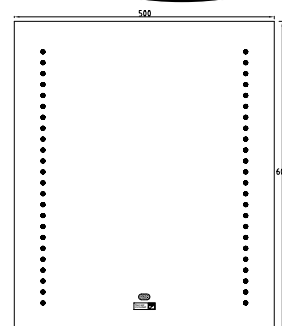

CODE
M1013

DESCRIPTION

TECHNICAL
Depth: 50mm
Height: 600mm
Width: 500mm
Lamp type: LED x 60
Lamp: Included
Switched: Sensor
Weight: 7.5Kg
Material: Mirror / Steel



INC VAT
£335.97

TVA INC
450.20€

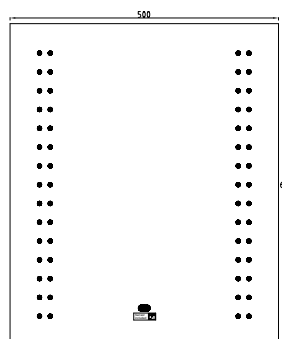

CODE
M1016

DESCRIPTION

TECHNICAL
Depth: 50mm
Height: 500mm
Width: 390mm
Lamp type: 15W T8 x 2
Lamp: Included
Switched: Pull Chord
Max Ampage: 0.21A
Weight: 8.9Kg
Material: Mirror / Steel

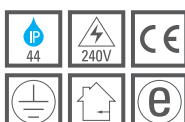

INC VAT
£232.12

TVA INC
311.03€

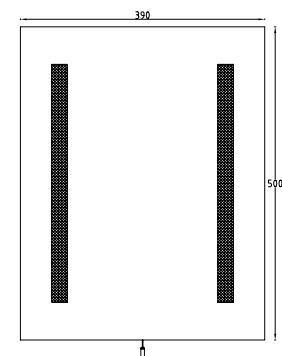

CODE
M1020

DESCRIPTION
LUMINOSO 60 x 60cm mirror with LED

CODE
M1021

DESCRIPTION
LUMINOSO 60 x 70cm mirror with LED

INC VAT
£218.36

TVA INC
292.61€

INC VAT
£231.47

TVA INC
310.16€

ILLUMINATE



CODE
M1040

DESCRIPTION
DUSK 120 x 70cm mirror with LED

INC VAT
£362.56

TVA INC
485.84€

Qui est-ce ?...
Votre reflet nous appartient. Nos armoires et miroirs sont conçus pour durer, tout comme l'éclairage LED, qui est facile à remplacer.





AGUA MAISON

the search is over . . .

La recherche est terminée . . .

Very cool, very now.

With an automatic showering area created because of the Stetson steep sides – any 1 of these 8 baths will be a joy to use, a pleasure to clean and stunning to look at for a long time.

Très cool, très actuel.

Espace douche /// Grâce à leur système de vidage automatique, spécialement créé en raison des des baignoires Stetson, vous prendrez plaisir à utiliser, nettoyer et admirer ces baignoires, et ce, pendant des années.



Breathtaking stuff...

Agua Maison freestanding baths are an improvement on the vintage freestanding baths. With double skinned acrylic structure, our baths are a stunning piece for a real sensational bathroom

WOW!

Des produits à couper le souffle...

Les baignoires îlots Agua Maison représentent un progrès par rapport aux anciens modèles. Grâce à leur structure en acrylique renforcé, nos magnifiques baignoires sont conçues pour donner un effet sensationnel à votre salle de bains.

WOW!



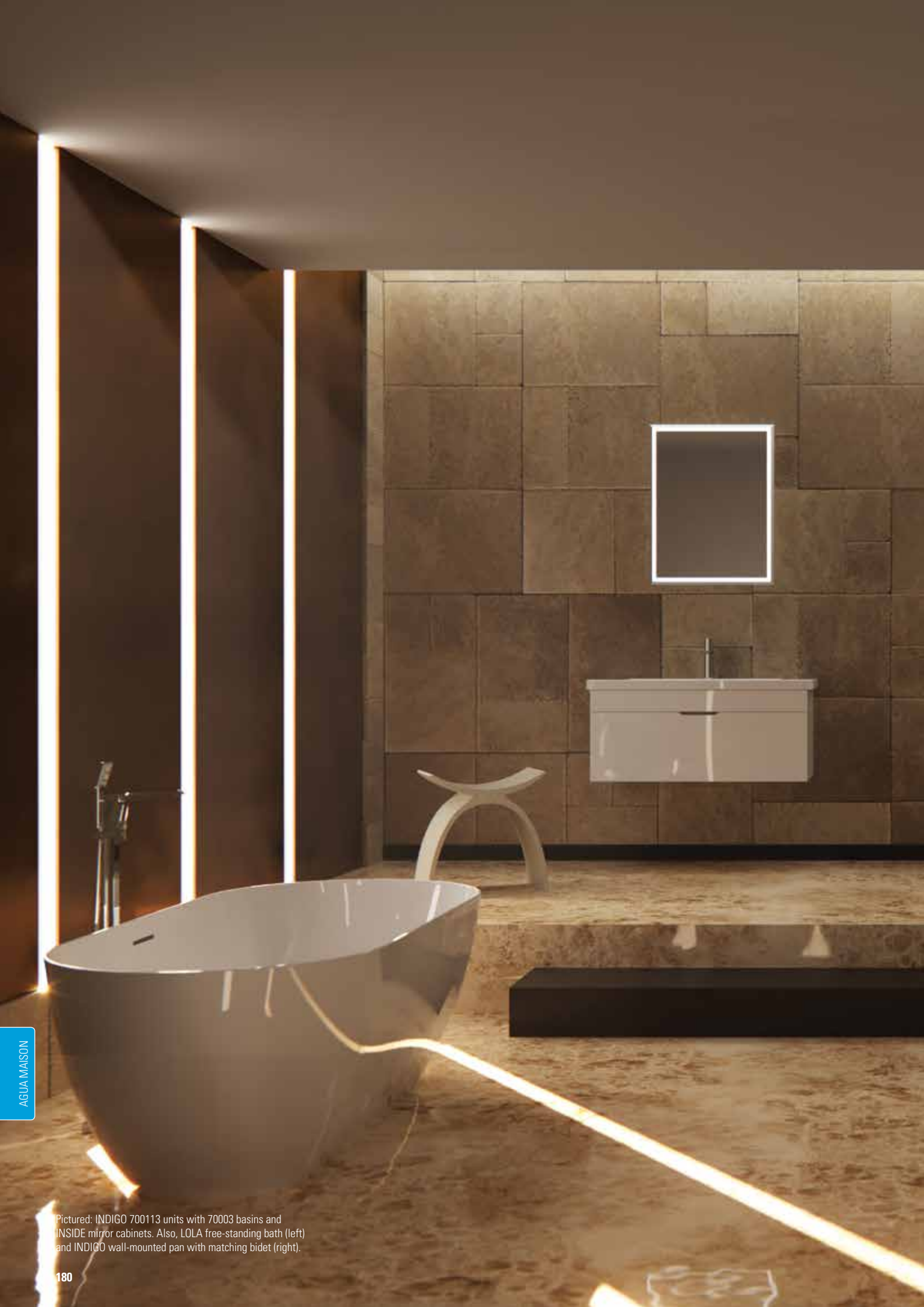

Pictured: INDIGO 700113 units with 70003 basins and INSIDE mirror cabinets. Also, LOLA free-standing bath (left) and INDIGO wall-mounted pan with matching bidet (right).



AGUA MAISON

Agua Maison

All Stetson baths are 5mm acrylic with fibreglass reinforcement & have a fully encapsulated 18mm baseboard for added strength & rigidity

Toutes les baignoires Stetson sont composées d'une structure en acrylique de 5 mm et renforcées avec de la fibre de verre. En outre, elles sont dotées d'une plinthe de 18 mm entièrement encastrée qui permet de renforcer leur solidité et leur rigidité.

CODE
20145

DESCRIPTION
Stetson 1700 x 700mm bath – single ended
160 ltr capacity

INC VAT £390.00
TVA INC 522.60€

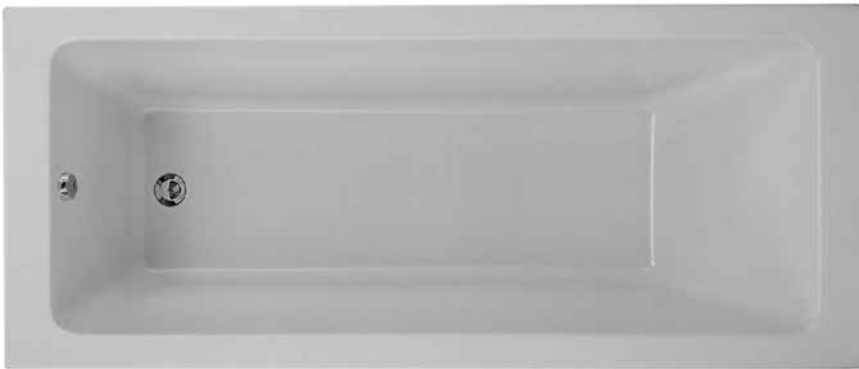
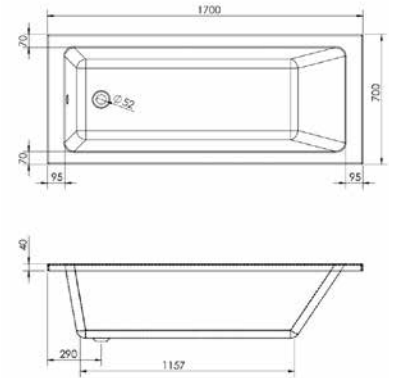

CODE
20146

DESCRIPTION
Stetson 1700 x 700mm bath – double ended
155 ltr capacity

INC VAT £390.00
TVA INC 522.60€

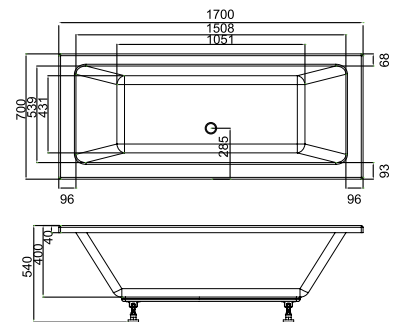

All Stetson baths are 5mm acrylic with fibreglass reinforcement & have a fully encapsulated 18mm baseboard for added strength & rigidity
 Toutes les baignoires Stetson sont composées d'une structure en acrylique de 5 mm et renforcées avec de la fibre de verre. En outre, elles sont dotées d'une plinthe de 18 mm entièrement encastrée qui permet de renforcer leur solidité et leur rigidité.

CODE
20152

DESCRIPTION
Stetson 1700 x 750mm bath – single ended
205 ltr capacity

INC VAT £410.00
TVA INC 549.40€

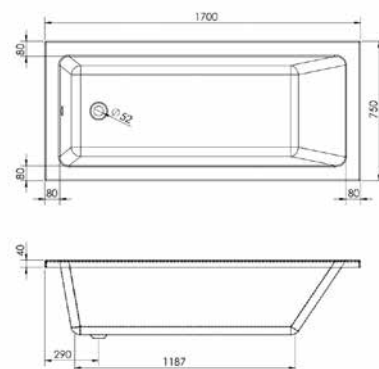

CODE
20151

DESCRIPTION
Stetson 1700 x 750mm bath – double ended
195 ltr capacity

INC VAT £410.00
TVA INC 549.40€

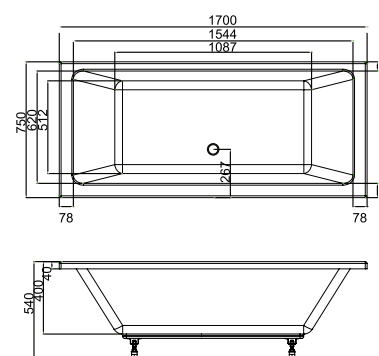

Agua Maison . . .

All Stetson baths are 5mm acrylic with fibreglass reinforcement & have a fully encapsulated 18mm baseboard for added strength & rigidity

Toutes les baignoires Stetson sont composées d'une structure en acrylique de 5 mm et renforcées avec de la fibre de verre. En outre, elles sont dotées d'une plinthe de 18 mm entièrement encastrée qui permet de renforcer leur solidité et leur rigidité.

CODE
20155

DESCRIPTION

Stetson 1800 x 800mm bath – single ended
230 ltr capacity

INC VAT
£520.00

TVA INC
696.80€

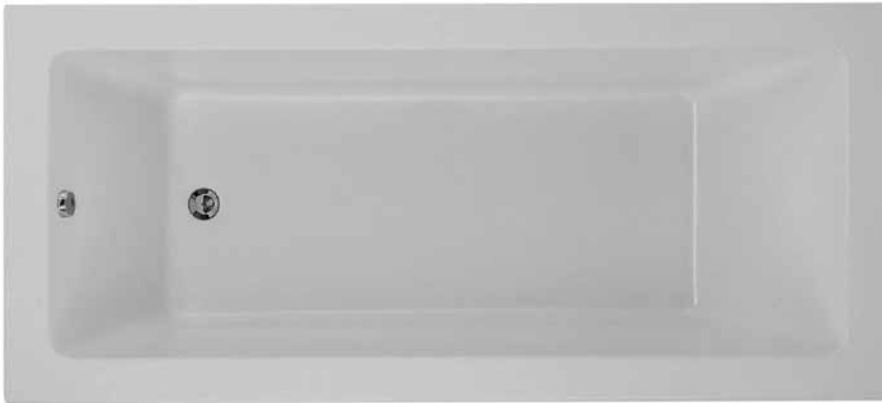
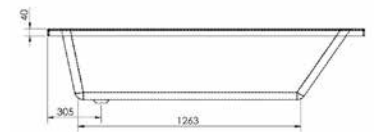
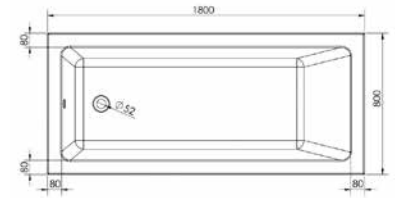

CODE
20154

DESCRIPTION

Stetson 1800 x 800mm bath – double ended
230 ltr capacity

INC VAT
£520.00

TVA INC
696.80€

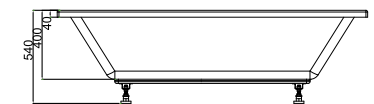
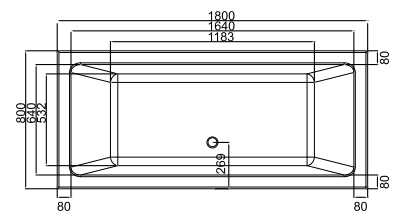

All Stetson baths are 5mm acrylic with fibreglass reinforcement & have a fully encapsulated 18mm baseboard for added strength & rigidity
 Toutes les baignoires Stetson sont composées d'une structure en acrylique de 5 mm et renforcées avec de la fibre de verre. En outre, elles sont dotées d'une plinthe de 18 mm entièrement encadrée qui permet de renforcer leur solidité et leur rigidité.

CODE
20158

DESCRIPTION
Stetson 1800 x 1000mm bath – double ended
290 ltr capacity

INC VAT £950.00
TVA INC 1273.00€

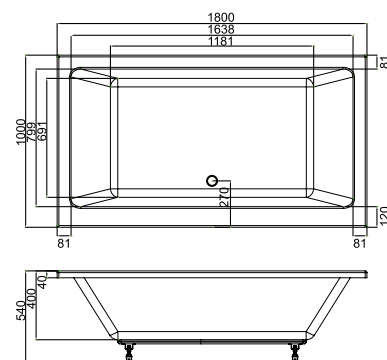

CODE
70155
70156

DESCRIPTION
Indigo 1800 x 800mm d-shaped bath
Indigo D-bath Front and LH/RH side panels

INC VAT £422.65
£247.00
TVA INC 566.36€
330.98€

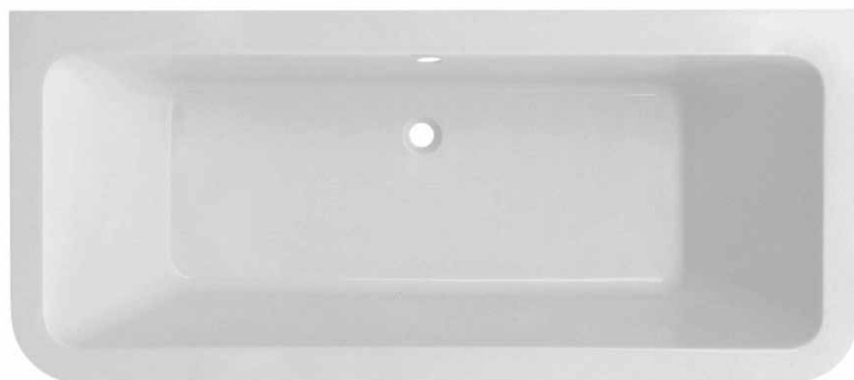
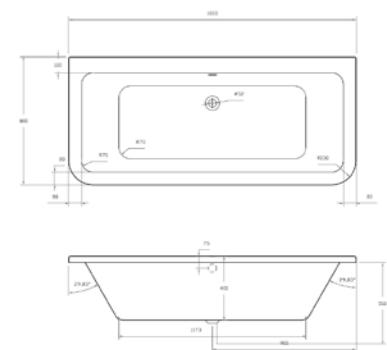

CODE
20160
20161
20162L
20162R
20163
20164

DESCRIPTION
Left handed square shower bath tub 1700 x 850
Right handed square shower bath tub 1700 x 850
Shower screen
Shower screen
Front panel
End panel

INC VAT £475.00
£475.00
£296.86
£296.86
£122.16
£73.31
TVA INC 636.50€
636.50€
397.79€
397.79€
163.70€
98.23€

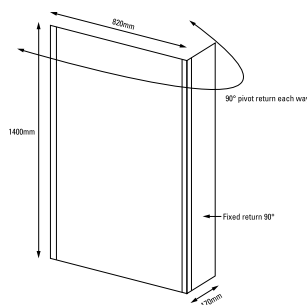
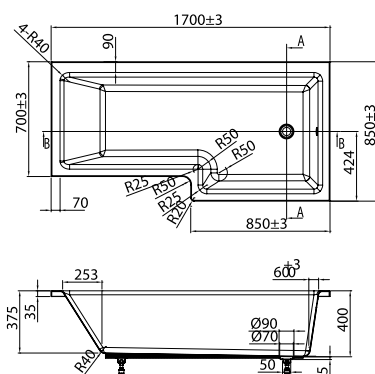

Left hand shown in above image

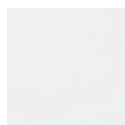

CODE	DESCRIPTION	INC VAT	TVA INC
BP1701	1700 x 415mm white gloss bath panel and plinth	£164.93	221.01€
BP1801	1800 x 415mm white gloss bath panel and plinth	£182.04	243.94€
BP7001	700 x 415mm white gloss end panel and plinth	£103.84	139.15€
BP7501	750 x 415mm white gloss end panel and plinth	£103.84	139.15€
BP8001	800 x 415mm white gloss end panel and plinth	£124.61	166.97€
BP1001	1000 x 415mm white gloss end panel and plinth	£124.61	166.97€

Plinth depth 140mm

Available for AUSTEN, MATTEO, PODIUM



CODE	DESCRIPTION	INC VAT	TVA INC
BP1702	1700 x 415mm black gloss bath panel and plinth	£164.93	221.01€
BP1802	1800 x 415mm black gloss bath panel and plinth	£182.04	243.94€
BP8002	800 x 415mm black gloss end panel and plinth	£124.61	166.97€
BP1002	1000 x 415mm black gloss end panel and plinth	£124.61	166.97€

Plinth depth 140mm

Available for AUSTEN, MATTEO, PODIUM



CODE	DESCRIPTION	INC VAT	TVA INC
BP1703	1700 x 415mm wengé bath panel and plinth	£140.33	188.04€
BP1803	1800 x 415mm wengé bath panel and plinth	£147.49	197.64€
BP7003	700 x 415mm wengé end panel and plinth	£75.92	101.74€
BP7503	750 x 415mm wengé end panel and plinth	£72.34	96.94€
BP8003	800 x 415mm wengé end panel and plinth	£75.92	101.74€
BP1003	1000 x 415mm wengé end panel and plinth	£124.61	166.97€

Plinth depth 140mm

Available for MATTEO



CODE	DESCRIPTION	INC VAT	TVA INC
BP1716	1700 x 415mm golden oak bath panel and plinth	£164.93	221.01€
BP1816	1800 x 415mm golden oak bath panel and plinth	£164.93	221.01€
BP7016	700 x 415mm golden oak bath panel and plinth	£124.61	166.98€
BP8016	800 x 415mm golden oak bath panel and plinth	£124.61	166.98€

Plinth depth 140mm

Available for MATTEO



CODE	DESCRIPTION	INC VAT	TVA INC
BP1705	1700 x 415mm grey gloss bath panel and plinth	£164.93	221.01€
BP1805	1800 x 415mm grey gloss bath panel and plinth	£164.93	221.01€
BP7005	700 x 415mm grey gloss bath panel and plinth	£124.61	166.98€
BP7505	750 x 415mm grey gloss bath panel and plinth	£124.61	166.98€
BP8005	800 x 415mm grey gloss bath panel and plinth	£124.61	166.98€

Plinth depth 140mm

Available for INDIGO, MATTEO



CODE	DESCRIPTION	INC VAT	TVA INC
MBP1703	1700 x 415mm zulu bath panel and plinth	£323.71	433.77€
MBP1803	1800 x 415mm zulu bath panel and plinth	£334.91	448.78€
MBP7003	700 x 415mm zulu gloss bath panel and plinth	£200.50	268.67€
MBP7503	750 x 415mm zulu bath panel and plinth	£211.70	283.68€
MBP8003	800 x 415mm zulu bath panel and plinth	£222.89	298.67€

Plinth depth 140mm

Available for MATTEO, PODIUM





CODE	DESCRIPTION	INC VAT	TVA INC
BP8006	800 x 415mm alaska bath panel & plinth	£111.46	149.35€
BP7006	700 x 415mm alaska bath panel & plinth	£92.87	124.45€
BP1806	1800 x 415mm alaska bath panel & plinth	£162.83	218.19€
BP1706	1700 x 415mm alaska bath panel & plinth	£147.52	197.68€
BP7506	750 x 415mm alaska bath panel & plinth	£92.87	124.45€



Available for AUSTEN

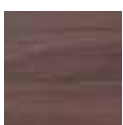

CODE	DESCRIPTION	INC VAT	TVA INC
BP7007	700 x 415mm pacific walnut bath panel & plinth	£96.48	129.28€
BP7507	750 x 415mm pacific walnut bath panel & plinth	£96.48	129.28€
BP8007	800 x 415mm pacific walnut bath panel & plinth	£115.79	155.15€
BP1707	1700 x 415mm pacific walnut bath panel & plinth	£153.25	205.36€
BP1807	1800 x 415mm pacific walnut bath panel & plinth	£169.15	226.66€



Available for AUSTEN



CODE	DESCRIPTION	INC VAT	TVA INC
BG1703	1700 x 415mm new wengé bath panel and plinth	£164.93	221.01€
BG1803	1800 x 415mm new wengé bath panel and plinth	£182.05	243.94€
BG7003	700 x 415mm new wengé bath panel and plinth	£103.85	139.16€
BG8003	800 x 415mm new wengé bath panel and plinth	£124.61	166.98€

Plinth depth 140mm



Available for MATTEO

CODE	DESCRIPTION	HEIGHT (MM)	EXT (MM)	INC VAT	TVA INC
S2850	Radius shaped bath screen including towel rail 6mm glass 180° pivot	1400	775 – 800	£251.68	337.25€



CODE	DESCRIPTION	HEIGHT (MM)	EXT (MM)	INC VAT	TVA INC
S2852	Square & hinged bath screen 6mm glass 180° pivot	100	775-800	£177.14	237.37€



FREE-STANDING BATHS



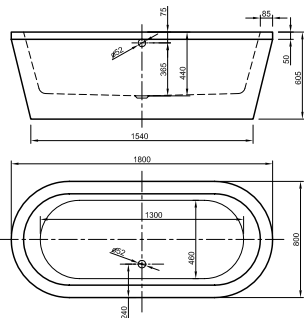

CODE 21101
DESCRIPTION Ovale 1800 x 800mm freestanding tub
 240 ltr capacity
 inc waste

INC VAT £3,054.27
TVA INC 4092.72€

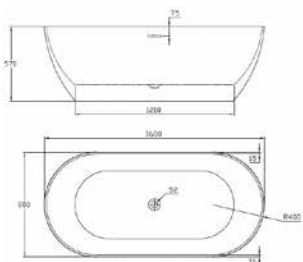

CODE 21105
DESCRIPTION Lola 1700 x 800mm freestanding bath tub
 inc waste

INC VAT £1,700.00
TVA INC 2278.00€

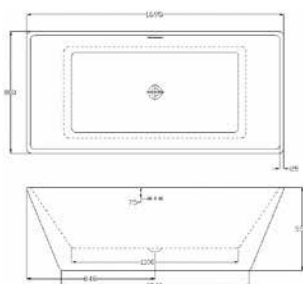

CODE 21106
DESCRIPTION Vista 1695 x 800mm freestanding bath tub
 inc waste

INC VAT £1,700.00
TVA INC 2278.00€

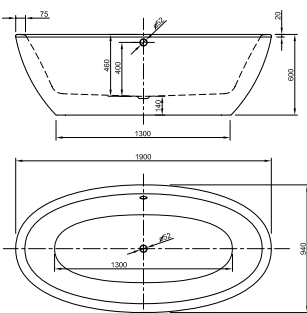
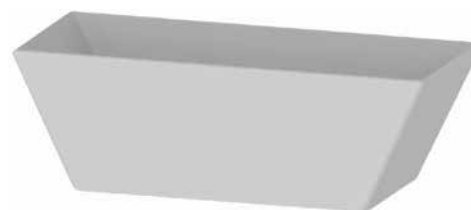

CODE 21104
DESCRIPTION Dolce 1900 x 940 freestanding tub
 240 ltr capacity
 inc waste

INC VAT £3,176.44
TVA INC 4256.43€

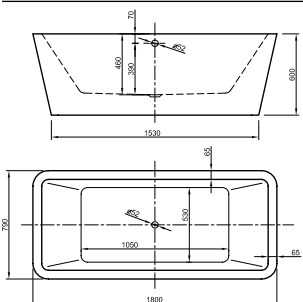

CODE 21100
DESCRIPTION Ellington 1800 x 790mm freestanding tub
 240 ltr capacity
 inc waste

INC VAT £3,298.62
TVA INC 4420.15€

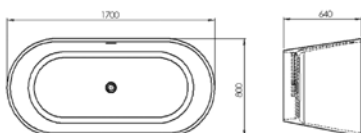

CODE 21107
DESCRIPTION Zaha 1700 x 800mm freestanding tub
 inc waste

INC VAT £3,100.00
TVA INC 4154.00€



JOLLY BATH WASTES AND BATH FILLERS



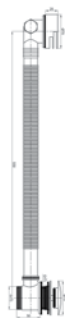

CODE	DESCRIPTION	INC VAT	TVA INC
CO100	Cos round bath filler with clicker waste & overflow	£107.71	144.33€

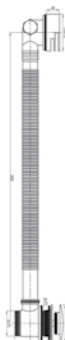

CODE	DESCRIPTION	INC VAT	TVA INC
TO100	Tooga square bath filler with clicker waste & overflow	£119.78	160.50€



CODE	DESCRIPTION	INC VAT	TVA INC
AC004	Jollypop bath pop-up waste and overflow. For large and small bath.	£58.84	78.85€



CODE	DESCRIPTION	INC VAT	TVA INC
AC005	Jollyclick bath clicker waste and overflow. For standard bath.	£79.61	106.67€

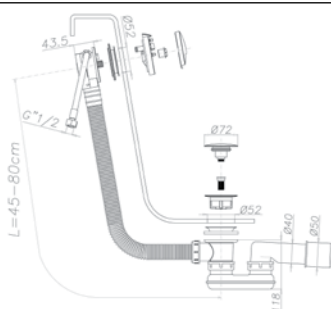

CODE	DESCRIPTION	INC VAT	TVA INC
AC116	Jollysluice bath clicker waste, overflow & bath filler combined. For large and small bath.	£248.05	332.38€

NEW ONLY 30MM PROJECTION

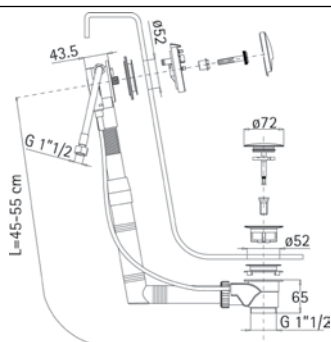

CODE	DESCRIPTION	INC VAT	TVA INC
AC117	Jollysluice bath pop-up waste, overflow & filler combined. For standard bath.	£184.58	247.34€

NEW ONLY 30MM PROJECTION





CLEARSEAL . . .
the protective coating
that effectively cleans
your shower for you . . .

ENDUIT TRANSPARENT

L'enduit de protection qui nettoie efficacement votre douche pour vous . . .

CLEARSEAL COMES AS STANDARD ON EVERY SHOWER ENCLOSURE IN OUR COLLECTION

To help keep your shower enclosure looking like new, every design we offer features Clearseal technology at no extra cost.

UN ENDUIT TRANSPARENT EST APPLIQUÉ DE SÉRIE SUR TOUTES NOS PAROIS DE DOUCHE

Dans l'objectif de permettre aux parois de votre douche de conserver l'aspect du neuf, un enduit transparent est appliqué sur chacune de ces parois, et ce, sans aucun coût supplémentaire.



How does it work?

Clearseal is a micro-thin invisible coating that we apply as standard to the glass in all our shower enclosures. This innovative technology creates a surface that water and grime are unable to stick to, creating a lasting mark-free finish.

Comment cela fonctionne-t-il ?

Il s'agit d'un enduit invisible ultra-fin que nous appliquons de série sur le verre de toutes nos parois de douche. Cette technologie innovante entraîne la formation d'une surface à laquelle l'eau et la crasse ne peuvent adhérer. Les parois de douche sont ainsi exemptes de traces.

Keeps cleaner for longer

Over time, the glass panels in shower enclosures can become tarnished by a build up of limescale and soap residue from shower gels and shampoos. By preventing the adherence of these products, Clearseal's protective coating keeps glass looking cleaner for longer.

Maintient les parois plus propres, plus longtemps

Au fil du temps, le verre des parois de douche peut se ternir en raison d'une accumulation de calcaire et de résidus de savon. En empêchant ces produits d'adhérer au verre, l'enduit transparent maintient les parois plus propres, plus longtemps.

Warranty

Clearseal has been developed to be effective and durable, offering long lasting protection on every enclosure we supply. To give you added peace of mind, every Clearseal coated design is fully guaranteed for 2 years.

Garantie

L'enduit transparent a été développé dans l'objectif d'être efficace et durable, offrant ainsi une protection longue durée à chaque paroi que nous fabriquons. Chaque produit sur lequel est appliqué cet enduit transparent est garanti 2 ans. Ainsi, vous aurez l'esprit tranquille.



Environmentally friendly

Because Clearseal makes your shower enclosure effectively self-cleaning, you don't have to use chemical-based sprays and other products, making it a more environmentally friendly choice.

Écologique

Vous n'avez pas à utiliser de produits chimiques ou autres, puisque l'enduit transparent nettoie efficacement les parois de votre douche pour vous. Une caractéristique qui fait de cette solution un choix écologique.

Clearseal repels water and grime. . . L'enduit transparent éloigne l'eau et la crasse. . .



Water and grime particles cling to untreated glass

Les particules d'eau et de crasse adhèrent aux surfaces non traitées

Clearseal coating means your shower stays cleaner for longer

L'enduit transparent maintient les parois de votre douche plus propres, plus longtemps

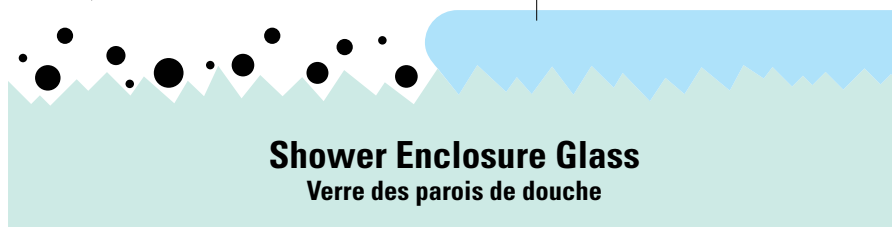

Shower Enclosure Glass
Verre des parois de douche











All of our showers
are protected with
clearseal technology

Toutes nos douches sont protégées
grâce à un enduit transparent



Features ...

-  CLEARSEAL coating
-  Low level trays available
-  Power shower suitable
-  Reversible doors
-  Magnetic Seals
-  Adjustment
-  Toughened glass
-  Installer friendly

Styles

FINISH: Polished aluminium
FRAME: Aluminium
GLASS: 8mm toughened clearseal

B (optional)

Optional extras

Reversible side panel with 2cm adjustment (B)

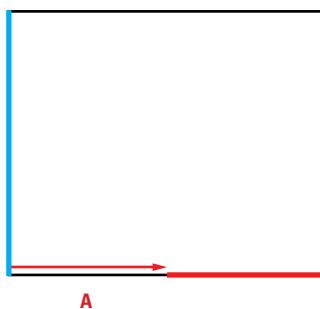

the shower zone ...

Products to complement your shower ...



See our Shower Packages for all shower brassware configurations

Slider (A)

Code	Description	Tray Size (mm)	Ext (mm)	Height (mm)	Opening (mm)	INC VAT	TVA INC
S4500	8mm slider only	1000	955 – 995	2000	335	£740.91	992.82€
S4505	8mm slider only	1200	1155 – 1195	2000	450	£798.53	1070.03€
S4510	8mm slider only	1400	1355 – 1395	2000	535	£846.75	1134.65€
S4515	8mm slider only	1600	1555 – 1595	2000	580	£958.48	1284.36€
S4520	8mm slider only	1700	1655 – 1695	2000	580	£986.70	1322.18€

Optional side panel (B)

Code	Description	Tray Size (mm)	Ext (mm)	Height (mm)	INC VAT	TVA INC
S4550	8mm side panel	760	730 – 755	2000	£433.95	581.50€
S4551	8mm side panel	800	770 – 795	2000	£458.65	614.59€
S4552	8mm side panel	900	870 – 895	2000	£482.18	646.12€



Configurations



All front/side panels are intercompatible. They are both reversible for a L/R configuration as shown above. Finally, complete the look by choosing one of our H25 shower trays on page 229.

Toutes les parois avant/latérales sont compatibles entre elles. Elles sont réversibles gauche/droite, comme le montre le schéma ci-dessus. Complétez votre douche en choisissant l'un de nos receveurs H25 disponibles en page 229.

Our golden seal of quality... our shower doors offer exceptional class as standard with magnetic full length seals which will stand the test of time

WOW!



Notre label qualité... D'une classe exceptionnelle, nos portes de douche sont dotées de série de joints magnétiques. Ces joints couvrent toute la longueur des portes et résisteront à l'épreuve du temps.

WOW!



Steel . . .

Quadrant

Features . . .



CLEARSEAL coating



Low level trays available



Power shower suitable



Adjustment



Magnetic Seals



Installer friendly



Toughened glass

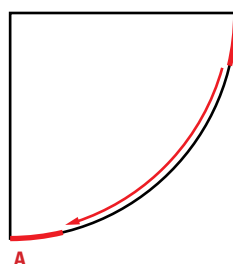

Styles

FINISH: Polished aluminium

FRAME: Aluminium

GLASS: 8mm toughened clearseal

the shower zone . . .

Products to complement your shower . . .

See our Shower Packages for all shower brassware configurations

Quadrant (A)

Code	Description	Tray Size (mm)	Ext (mm)	Height (mm)	Opening (mm)	INC VAT	TVA INC
S4400	8mm quadrant	800	770 – 795	2000	390	£938.48	1257.56€
S4402	8mm quadrant	900	870 – 895	2000	430	£998.45	1337.92€
S4404	8mm quadrant	1000	970 – 995	2000	430	£1045.41	1400.84€

Configurations

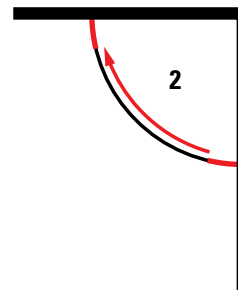
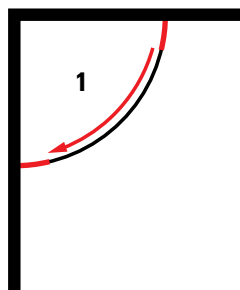

Steel Quadrants are creations of classic design - with bold frames and absolutely flawless operation. Finally, complete the look by choosing one of our H25 shower trays on page 229

A modern glass shower enclosure is shown in a bathroom with grey tiled walls and a light wood floor. The shower has a curved glass door and a fixed glass panel. A showerhead and a handheld shower wand are mounted on the wall. A towel rack with a white towel is visible on the right side of the image.

All of our showers
are protected with
clearseal technology
Toutes nos douches sont protégées
grâce à un enduit transparent



Features . . .



CLEARSEAL coating



Low level trays available



Power shower suitable



Adjustment



Magnetic Seals



Installer friendly



Toughened glass

Styles

FINISH: Polished aluminium

FRAME: Aluminium

GLASS: 8mm toughened clearseal

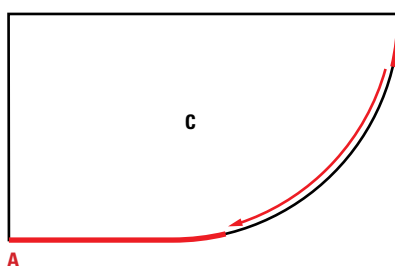

the shower zone . . .

Products to complement your shower . . .

See our Shower Packages for all shower brassware configurations

Offset Quadrant (A)

Code	Description	Tray Size (mm)	Ext (mm)	Height (mm)	Opening (mm)	INC VAT	TVA INC
S4410L	LH 8mm offset quadrant	1000 x 800	970 – 995 x 770 – 795	2000	430	£1028.87	1378.68€
S4410R	RH 8mm offset quadrant	1000 x 800	970 – 995 x 770 – 795	2000	430	£1044.22	1399.25€
S4412L	LH 8mm offset quadrant	1200 x 800	1170 – 1195 x 770 – 795	2000	430	£1045.91	1401.52€
S4412R	RH 8mm offset quadrant	1200 x 800	1170 – 1195 x 770 – 795	2000	430	£1106.97	1483.34€
S4414L	RH 8mm offset quadrant	1200 x 900	1170 – 1195 x 870 – 895	2000	430	£1055.91	1414.92€
S4414R	RH 8mm offset quadrant	1200 x 900	1170 – 1195 x 870 – 895	2000	430	£1087.52	1457.27€

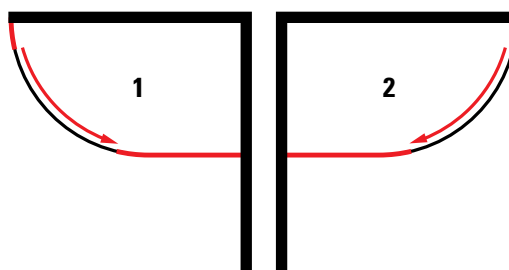

Configurations

Complete the STEEL offset quadrant look by choosing one of our H25 shower trays on page 229







Complétez votre douche d'angle en choisissant l'un de nos receveurs H25 disponibles en page 229.



All of our showers
are protected with
clearseal technology
Toutes nos douches sont protégées
grâce à un enduit transparent



Features ...

-  CLEARSEAL coating
-  Reversible doors
-  Power shower suitable
-  Adjustment 3mm
-  Wetroom compatible
-  Installer friendly
-  Toughened glass

Styles

FINISH: Polished aluminium
FRAME: Aluminium
GLASS: 8mm toughened clearseal

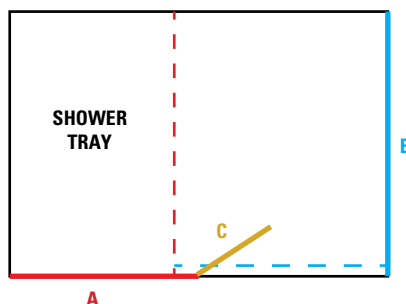

the shower zone ...

Products to complement your shower ...



See our Shower Packages for all shower brassware configurations

Front / Side panels (A/B)

Code	Description	Size (Width)	Ext (mm)	Height (mm)	INC VAT	TVA INC
S2960	8mm Walk-in front/side panel inc telescopic bar 600mm	600mm	570-600	1950	£238.80	319.99€
S2970	8mm Walk-in front/side panel inc telescopic bar 700mm	700mm	670-700	1950	£255.52	342.39€
S2980	8mm Walk-in front/side panel inc telescopic bar 800mm	800mm	770-800	1950	£268.36	359.60€
S2990	8mm Walk-in front/side panel inc telescopic bar 900mm	900mm	870-900	1950	£281.20	376.80€
S2910	8mm Walk-in front/side panel inc telescopic bar 1000mm	1000mm	970-1000	1950	£319.72	428.42€
S2911	8mm Walk-in front/side panel inc telescopic bar 1100mm	1100mm	1070-1100	1950	£332.56	445.63€
S2912	8mm Walk-in front/side panel inc telescopic bar 1200mm	1200mm	1170-1200	1950	£345.40	462.83€

Flipper panel (C)

Code	Description	Size (Width)	Ext (mm)	Height (mm)	INC VAT	TVA INC
S2930	Optional - 8mm Walk-in flipper panel	300	270-300	1950	£165.64	221.95€

Optional Arms (A/B)

Code	Description	Size (Width)	INC VAT	TVA INC
S2838	8mm Walk-in ceiling support arm 450mm	450mm	£57.78	77.43€

Configurations

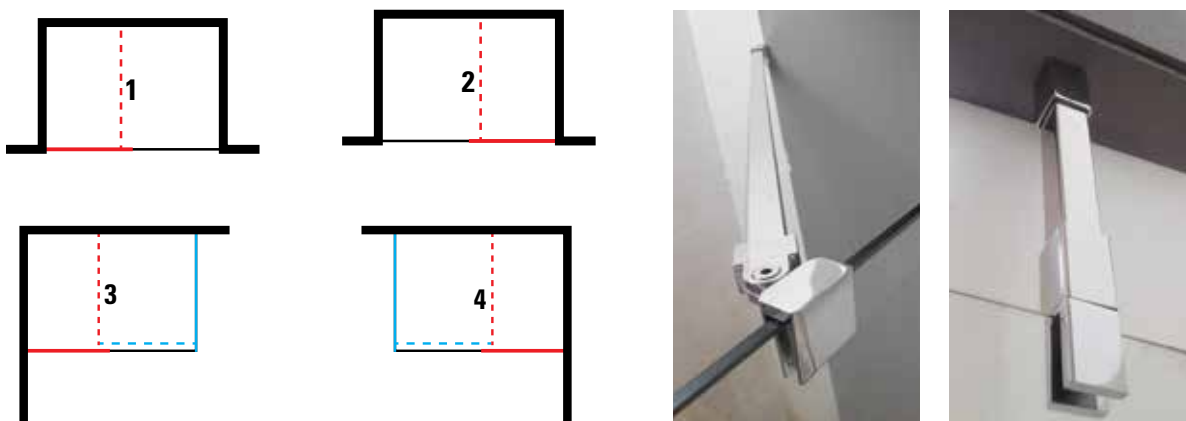

All front/side panels are intercompatible. They are both reversible (L/R configuration) and can be used as a side panel. All possible - using the TRU-LOK technology.

Toutes les parois avant/latérales sont compatibles entre elles. Elles sont réversibles gauche/droite et peuvent être utilisées comme parois latérales. Tout est possible, grâce à la technologie TRU-LOK.

Features

Push down hinges
for easy cleaning



Keep 'em rolling...

our sliding shower door mechanism is tested 25,000 times for opening and closing. Sad fact – if you used your shower door every day (that's opening to get in and opening to get out) to reach 25,000 times this would take approx 34 years





Features ...



CLEARSEAL coating



Low level trays available



Power shower suitable



Reversible doors



Magnetic Seals



Installer friendly



Toughened glass

Styles

FINISH: Polished aluminium

FRAME: Aluminium

GLASS: 6mm toughened clearseal

Optional extras

Reversible side panel with 2cm adjustment (B)

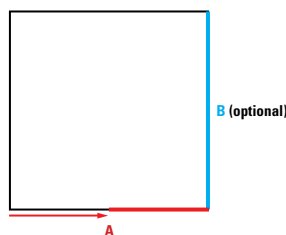

the shower zone ...

Products to complement your shower ...



See our Shower Packages for all shower brassware configurations

Slider (A)

Code	Description	Tray Size (mm)	Ext (mm)	Height (mm)	Opening (mm)	INC VAT	TVA INC
S2294	Slider	1000	960 - 1020	1850	400	£464.53	622.48€
S2296	Slider	1100	1060 - 1120	1850	450	£470.42	630.36€
S2300	Slider	1200	1160 - 1220	1850	490	£476.30	638.24€
S2310	Slider	1400	1360 - 1420	1850	580	£482.18	646.12€
S2320	Slider	1600	1560 - 1620	1850	645	£523.34	701.27€
S2330	Slider	1700	1660 - 1720	1850	645	£535.10	717.04€

Optional side panel (B)

Code	Description	Tray Size (mm)	Ext (mm)	Height (mm)	INC VAT	TVA INC
S2030	Side Panel	700	660 - 690	1850	£223.44	299.41€
S2040	Side Panel	760	720 - 750	1850	£225.79	302.56€
S2100	Side Panel	800	760 - 790	1850	£229.33	307.31€
S2105	Side Panel	900	860 - 890	1850	£235.21	315.19€
S2110	Side Panel	1000	960 - 990	1850	£241.08	323.05€



Configurations

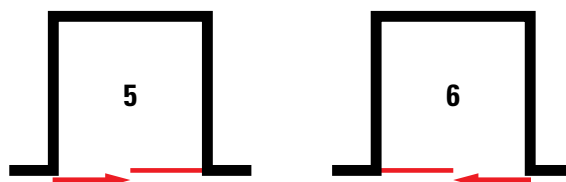



It don't get much better than this... all our glass is BS kitemarked which is of highest quality and all shower doors are rigorously tested to ensure leakfree and squeakfree use

WOW!

All of our showers are protected with clearseal technology
Toutes nos douches sont protégées grâce à un enduit transparent

Il ne se fait rien de mieux... Le verre de toutes nos douches est certifié BSI Kitemark™ et toutes les portes sont soumises à des tests rigoureux afin de s'assurer qu'elles sont étanches et qu'elles ne grincent pas.









WOW!



Wosh . . .

Pivot Door

Features . . .

-  CLEARSEAL coating
-  Low level trays available
-  Power shower suitable
-  Reversible doors
-  Magnetic Seals
-  2/4cm Adjustment
-  Toughened glass
-  Installer friendly

Styles

FINISH: Polished aluminium
FRAME: Aluminium
GLASS: 6mm toughened clearseal

Optional extras

Reversible side panel with 2cm adjustment (B)

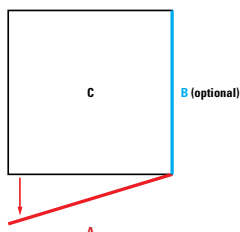

the shower zone . . .

Products to complement your shower . . .



See our Shower Packages for all shower brassware configurations

Pivot (A)	Code	Description	Tray Size (mm)	Ext (mm)	Height (mm)	Opening (mm)	INC VAT	TVA INC
	S1998	Pivot door	700	640 - 700	1850	458	£288.14	386.10€
	S1999	Pivot door	760	740 - 800	1850	468	£299.89	401.85€
	S2000	Pivot door	800	760 - 820	1850	508	£323.41	433.37€
	S2010	Pivot door	900	860 - 920	1850	608	£341.06	457.02€
	S2020	Pivot door w/ in-line panel	1000	960 - 1020	1850	698	£346.91	464.87€

Optional side panel (B)	Code	Description	Tray Size (mm)	Ext (mm)	Height (mm)	INC VAT	TVA INC
	S2030	Side Panel	700	660 - 690	1850	£223.44	299.41€
	S2040	Side Panel	760	720 - 705	1850	£225.79	302.56€
	S2100	Side Panel	800	760 - 790	1850	£229.33	307.31€
	S2105	Side Panel	900	860 - 890	1850	£235.21	315.19€
	S2110	Side Panel	1000	960 - 990	1850	£241.08	323.05€

Configurations

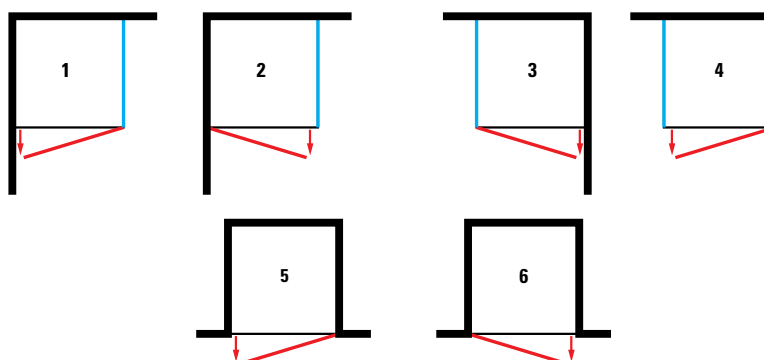



All of our showers
are protected with
clearseal technology

Toutes nos douches sont protégées
grâce à un enduit transparent



Features . . .



CLEARSEAL coating



Low level trays available



Power shower suitable



Reversible doors



Magnetic Seals



Installer friendly



Toughened glass

Styles

FINISH: Polished aluminium

FRAME: Aluminium

GLASS: 6mm toughened clearseal

Optional extras

Reversible side panel with 2cm adjustment (B)

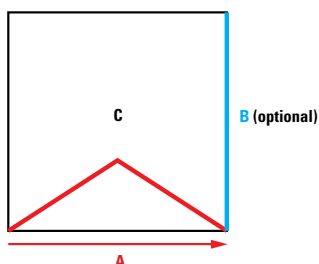

the shower zone . . .

Products to complement your shower . . .

See our Shower Packages for all shower brassware configurations

Bi-fold (A)

Code	Description	Tray Size (mm)	Ext (mm)	Height (mm)	Opening (mm)	INC VAT	TVA INC
S2115	Bi-fold door	700	660 – 720	1850	370	£446.90	598.85€
S2120	Bi-fold door	760	700 – 760	1850	430	£458.65	614.59€
S2200	Bi-fold door	800	740 – 800	1850	470	£464.53	622.48€
S2210	Bi-fold door	900	860 – 920	1850	570	£470.42	630.36€
S2220	Bi-fold door	1000	960 – 1020	1850	670	£476.30	638.24€

Optional side panel (B)

Code	Description	Tray Size (mm)	Ext (mm)	Height (mm)	INC VAT	TVA INC
S2030	Side Panel	700	675 – 695	1850	£223.44	299.41€
S2040	Side Panel	760	735 – 755	1850	£225.79	302.56€
S2100	Side Panel	800	775 – 795	1850	£229.33	307.31€
S2105	Side Panel	900	875 – 895	1850	£235.21	315.19€
S2110	Side Panel	1000	975 – 995	1850	£241.08	323.05€

Configurations

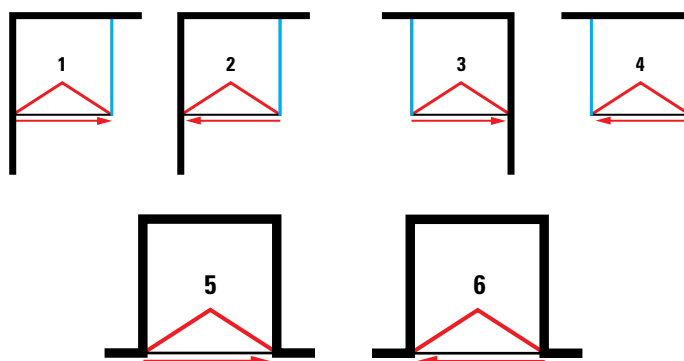

Features

Push down hinges
for easy cleaning



Easy peasy... a pucker shower is down to the details. That's why shower tray, screen, shower valve and shower head has to be of supreme quality. Our enclosures are made easy to install [with picture instructions] and even easier to use

WOW!



C'est simple comme bonjour... Lorsqu'il s'agit d'installer une douche d'angle (/// corner shower ?), le moindre détail a son importance. C'est la raison pour laquelle le receveur, la paroi, le mitigeur et la pomme de douche doivent être d'une qualité irréprochable. Nos parois sont faciles à installer (avec instructions illustrées) et encore plus faciles à utiliser.

WOW!



Wosh . . .

Quadrant

Features . . .



CLEARSEAL coating



Low level trays available



Power shower suitable



Reversible doors



Magnetic Seals



Adjustment



Toughened glass



Installer friendly

Styles

FINISH: Polished aluminium

FRAME: Aluminium

GLASS: 6mm toughened clearseal

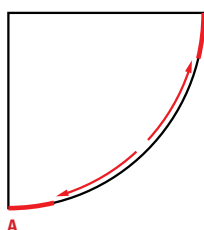

the shower zone . . .

Products to complement your shower . . .



See our Shower Packages for all shower brassware configurations

Quadrant (A)

Code	Description	Tray Size (mm)	Ext (mm)	Height (mm)	Opening (mm)	INC VAT	TVA INC
S2340	Quadrant	800	765 – 800 x 765 – 800	1850	390	£458.65	614.59€
S2350	Quadrant	900	865 – 900 x 865 – 900	1850	480	£470.42	630.36€
S2410	Quadrant	1000	965 – 1000 x 965 – 1000	1850	530	£562.14	753.27€

Configurations

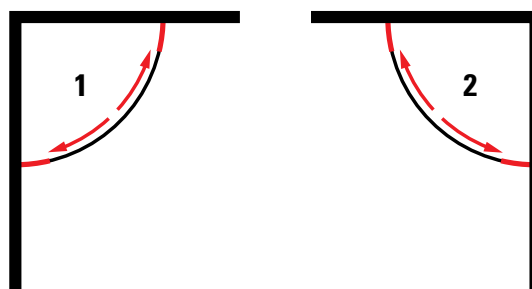

Features

Push down hinges
for easy cleaning



All of our showers
are protected with
clearseal technology
*Toutes nos douches sont protégées
grâce à un enduit transparent*



Features . . .



CLEARSEAL coating



Low level trays available



Power shower suitable



Reversible doors



Magnetic Seals



Adjustment



Toughened glass



Installer friendly

Styles

FINISH: Polished aluminium

FRAME: Aluminium

GLASS: 6mm toughened clearseal

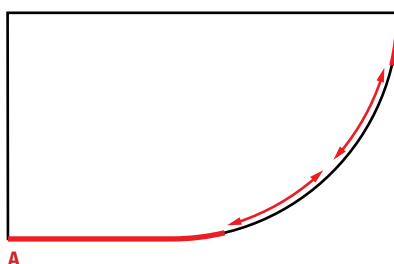

the shower zone . . .

Products to complement your shower . . .

See our Shower Packages for all shower brassware configurations

Offset quadrant (A)

Code	Description	Tray Size (mm)	Ext (mm)	Height (mm)	Opening (mm)	INC VAT	TVA INC
S2430	Offset Quadrant	1000 x 800	965 – 1000 x 765 – 800	1850	450	£570.38	764.31€
S2510	Offset Quadrant	1200 x 800	1165 – 1200 x 725 – 800	1850	430	£598.60	802.13€
S2520	Offset Quadrant	1200 x 900	1165 – 1200 x 865 – 900	1850	480	£546.85	732.78€

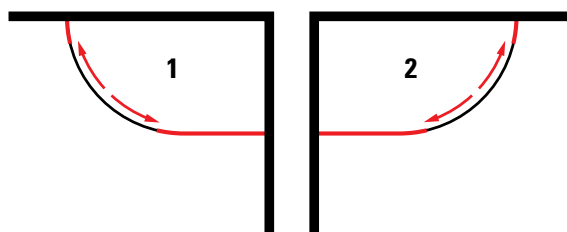

Configurations

H25 SHOWER TRAYS



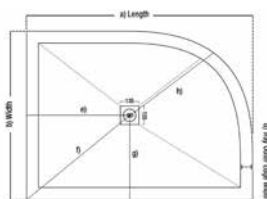

See our H25 range for 25mm ultra-slim stone resin trays
 Découvrez les receveurs en résine de pierre ultra-fins de 25 mm de notre gamme H25

Quadrant Trays

Code	Description	A	B	C	D	E	F	G	H	INC VAT	TVA INC
H2526	H25 Stone Resin Shower Tray 25mm Quad 800 x 800	800	800	24 – 27	60	400	565	400	340	£262.18	351.32€
H2527	H25 Stone Resin Shower Tray 25mm Quad 900 x 900	900	900	24 – 27	60	450	635	450	405	£281.96	377.82€
H2528	H25 Stone Resin Shower Tray 25mm Quad 1000 x 800 Q L/H	1000	800	24 – 27	60	500	645	400	415	£374.51	501.84€
H2529	H25 Stone Resin Shower Tray 25mm Quad 1000 x 800 Q R/H	1000	800	24 – 27	60	500	645	400	415	£374.51	501.84€
H2530	H25 Stone Resin Shower Tray 25mm Quad 1200 x 800 Q L/H	1200	800	24 – 27	60	600	725	400	495	£398.30	533.72€
H2531	H25 Stone Resin Shower Tray 25mm Quad 1200 x 800 Q R/H	1200	800	24 – 27	60	600	725	400	495	£398.30	533.72€
H2532	H25 Stone Resin Shower Tray 25mm Quad 1200 x 900 Q L/H	1200	900	24 – 27	60	600	745	450	555	£444.73	595.94€
H2533	H25 Stone Resin Shower Tray 25mm Quad 1200 x 900 Q R/H	1200	900	24 – 27	60	600	745	450	555	£444.73	595.94€

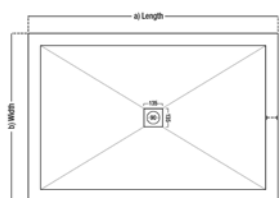

Rectangular Trays

Code	Description	A	B	C	D	INC VAT	TVA INC
H2503	H25 Stone Resin Shower Tray 25mm 1000 x 760 x 25	1000	760	24 – 27	60	£283.03	379.25€
H2504	H25 Stone Resin Shower Tray 25mm 1000 x 800 x 25	1000	800	24 – 27	60	£286.52	383.94€
H2505	H25 Stone Resin Shower Tray 25mm 1000 x 900 x 25	1000	900	24 – 27	60	£289.38	387.78€
H2507	H25 Stone Resin Shower Tray 25mm 1100 x 800 x 25	1100	800	24 – 27	60	£292.56	392.03€
H2508	H25 Stone Resin Shower Tray 25mm 1100 x 900 x 25	1100	900	24 – 27	60	£299.25	401.00€
H2509	H25 Stone Resin Shower Tray 25mm 1200 x 700 x 25	1200	700	24 – 27	60	£305.37	409.20€
H2510	H25 Stone Resin Shower Tray 25mm 1200 x 760 x 25	1200	760	24 – 27	60	£307.53	412.10€
H2511	H25 Stone Resin Shower Tray 25mm 1200 x 800 x 25	1200	800	24 – 27	60	£316.13	423.61€
H2512	H25 Stone Resin Shower Tray 25mm 1200 x 900 x 25	1200	900	24 – 27	60	£327.37	438.68€
H2513	H25 Stone Resin Shower Tray 25mm 1400 x 700 x 25	1400	700	24 – 27	60	£433.32	580.65€
H2514	H25 Stone Resin Shower Tray 25mm 1400 x 760 x 25	1400	760	24 – 27	60	£449.66	602.54€
H2515	H25 Stone Resin Shower Tray 25mm 1400 x 800 x 25	1400	800	24 – 27	60	£463.48	621.07€
H2516	H25 Stone Resin Shower Tray 25mm 1400 x 900 x 25	1400	900	24 – 27	60	£469.93	629.70€
H2517	H25 Stone Resin Shower Tray 25mm 1500 x 760 x 25	1500	760	24 – 27	60	£455.87	610.87€
H2518	H25 Stone Resin Shower Tray 25mm 1500 x 800 x 25	1500	800	24 – 27	60	£467.53	626.49€
H2519	H25 Stone Resin Shower Tray 25mm 1500 x 900 x 25	1500	900	24 – 27	60	£474.53	635.87€
H2520	H25 Stone Resin Shower Tray 25mm 1600 x 760 x 25	1600	760	24 – 27	60	£476.22	638.13€
H2521	H25 Stone Resin Shower Tray 25mm 1600 x 800 x 25	1600	800	24 – 27	60	£486.37	651.74€
H2522	H25 Stone Resin Shower Tray 25mm 1600 x 900 x 25	1600	900	24 – 27	60	£491.44	658.53€
H2523	H25 Stone Resin Shower Tray 25mm 1700 x 760 x 25	1700	760	24 – 27	60	£496.66	665.52€
H2524	H25 Stone Resin Shower Tray 25mm 1700 x 800 x 25	1700	800	24 – 27	60	£505.35	677.18€
H2525	H25 Stone Resin Shower Tray 25mm 1700 x 900 x 25	1700	900	24 – 27	60	£516.36	691.92€

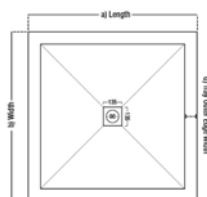

Square Trays

Code	Description	A	B	C	D	INC VAT	TVA INC
H2501	H25 Stone Resin Shower Tray 25mm Square 800 x 800	800	800	24 – 27	60	£254.76	341.37€
H2502	H25 Stone Resin Shower Tray 25mm Square 900 x 900	900	900	24 – 27	60	£273.96	367.11€



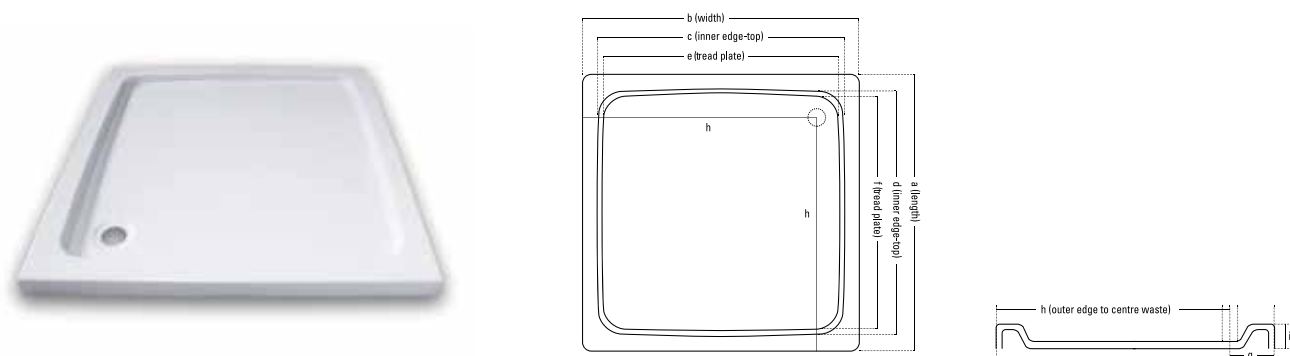

Square Trays

Code	Description	A	B	C	D	E	F	G	H	I	VOL	KG	INC VAT	TVA INC
S3011	760 x 760 square 45mm stone resin tray inc fast flow waste	760	760	660	660	655	655	145	610	45	13	15	£135.24	181.22€
S3021	800 x 800 square 45mm stone resin tray inc fast flow waste	800	800	690	690	685	685	145	645	45	14	16	£147.02	197.00€
S3031	900 x 900 square 45mm stone resin tray inc fast flow waste	900	900	795	795	790	790	140	755	45	18	21	£199.94	267.92€
S3041	1000 x 1000 square 45mm stone resin tray inc fast flow waste	1000	1000	890	890	875	875	165	830	45	23	30	£270.49	362.46€

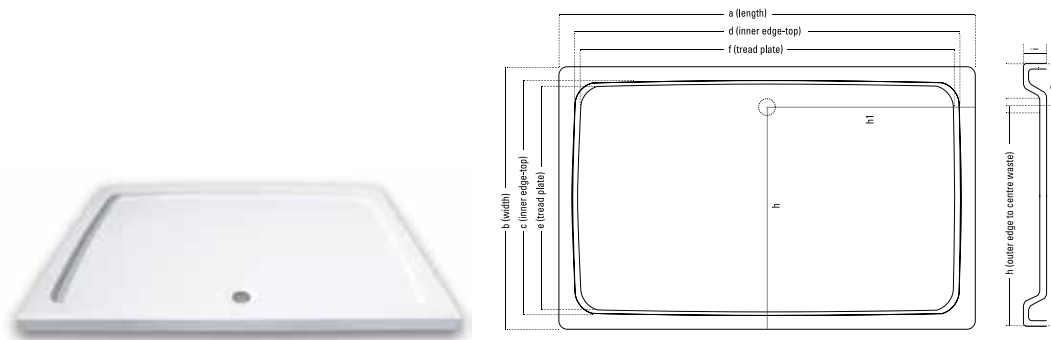

Rectangle Trays

Code	Description	A	B	C	D	E	F	G	H	H1	I	VOL	KG	INC VAT	TVA INC
S3051	800 x 700 45mm Rectangle stone resin tray inc fast flow waste	800	700	590	690	575	675	165	535	635	45	14	16	£217.57	291.54€
S3061	900 x 700 45mm Rectangle stone resin tray inc fast flow waste	900	700	590	790	575	775	165	535	735	45	15	17	£222.27	297.84€
S3071	900 x 760 45mm Rectangle stone resin tray inc fast flow waste	900	760	650	790	635	775	165	595	735	45	16	18	£225.79	302.56€
S3081	900 x 800 45mm Rectangle stone resin tray inc fast flow waste	900	800	690	790	660	780	145	745	650	45	16	21	£229.33	307.31€
S3091	1000 x 700 45mm Rectangle stone resin tray inc fast flow waste	1000	700	590	890	575	875	165	535	500	45	17	21	£231.69	310.46€
S3101	1000 x 760 45mm Rectangle stone resin tray inc fast flow waste	1000	760	650	890	640	875	165	535	500	45	17	22	£234.03	313.60€
S3111	1000 x 800 45mm Rectangle stone resin tray inc fast flow waste	1000	800	690	890	680	880	145	650	500	45	18	24	£231.69	310.46€
S3121	1000 x 900 45mm Rectangle stone resin tray inc fast flow waste	1000	900	790	885	770	870	170	735	505	45	19	28	£246.96	330.93€
S3131	1100 x 700 45mm Rectangle stone resin tray inc fast flow waste	1100	700	590	990	570	975	165	530	550	45	18	26	£248.14	332.50€
S3151	1100 x 800 45mm Rectangle stone resin tray inc fast flow waste	1100	800	690	990	670	970	165	630	550	45	20	28	£252.85	338.81€
S3161	1100 x 900 45mm Rectangle stone resin tray inc fast flow waste	1100	900	790	990	775	975	165	735	550	45	21	30	£252.85	338.81€
S3171	1200 x 700 45mm Rectangle stone resin tray inc fast flow waste	1200	700	590	1090	575	1075	185	535	600	45	19	28	£252.85	338.81€
S3181	1200 x 760 45mm Rectangle stone resin tray inc fast flow waste	1200	760	660	1110	655	1105	130	630	600	45	20	30	£232.86	312.03€
S3191	1200 x 800 45mm Rectangle stone resin tray inc fast flow waste	1200	800	705	1110	700	1105	132	670	600	45	21	30	£232.86	312.03€
S3201	1200 x 900 45mm Rectangle stone resin tray inc fast flow waste	1200	900	805	1110	795	1105	132	770	600	45	24	34	£241.08	323.05€
S3211	1400 x 700 45mm Rectangle stone resin tray inc fast flow waste	1400	700	590	1290	570	1275	165	535	700	45	22	34	£436.35	620.89€

Stone Resin Trays

S3221	1400 x 760 45mm Rectangle stone resin tray inc fast flow waste	1400	760	650	1295	635	1280	168	592	700	45	23	36	£464.53	622.48€
S3231	1400 x 800 45mm Rectangle stone resin tray inc fast flow waste	1400	800	690	1295	675	1280	150	650	700	45	25	36	£465.71	624.05€
S3241	1400 x 900 45mm Rectangle stone resin tray inc fast flow waste	1400	900	790	1290	780	1280	145	745	700	45	27	38	£432.78	579.93€
S3251	1500 x 700 45mm Rectangle stone resin tray inc fast flow waste	1500	700	590	1390	675	1375	165	635	750	45	25	42	£466.88	625.61€
S3261	1500 x 760 45mm Rectangle stone resin tray inc fast flow waste	1500	760	650	1400	635	1380	168	592	750	45	25	37	£466.88	625.61€
S3271	1500 x 800 45mm Rectangle stone resin tray inc fast flow waste	1500	800	690	1390	675	1375	165	635	750	45	25	42	£469.24	628.79€
S3281	1500 x 900 45mm Rectangle stone resin tray inc fast flow waste	1500	900	790	1390	770	1370	165	735	750	45	26	44	£470.42	630.36€
S3291	1600 x 700 45mm Rectangle stone resin tray inc fast flow waste	1600	700	590	1490	570	1475	170	535	800	45	27	42	£499.82	669.76€
S3301	1600 x 760 45mm Rectangle stone resin tray inc fast flow waste	1600	760	650	1490	630	1475	170	595	800	45	28	43	£503.35	674.49€
S3311	1600 x 800 45mm Rectangle stone resin tray inc fast flow waste	1600	800	690	1490	680	1480	145	645	800	45	28	41	£488.05	653.98€
S3321	1600 x 900 45mm Rectangle stone resin tray inc fast flow waste	1600	900	790	1490	770	1475	170	735	800	45	30	46	£499.82	669.76€
S3331	1700 x 700 45mm Rectangle stone resin tray inc fast flow waste	1700	700	590	1590	575	1580	150	550	850	45	26	43	£499.82	669.76€
S3341	1700 x 760 45mm Rectangle stone resin tray inc fast flow waste	1700	760	665	1590	635	1580	150	612	850	45	28	44	£499.82	669.76€
S3351	1700 x 800 45mm Rectangle stone resin tray inc fast flow waste	1700	800	690	1590	670	1570	165	635	850	45	30	48	£510.40	683.94€
S3361	1700 x 900 45mm Rectangle stone resin tray inc fast flow waste	1700	900	795	1590	780	1580	165	735	850	45	32	48	£516.27	691.80€

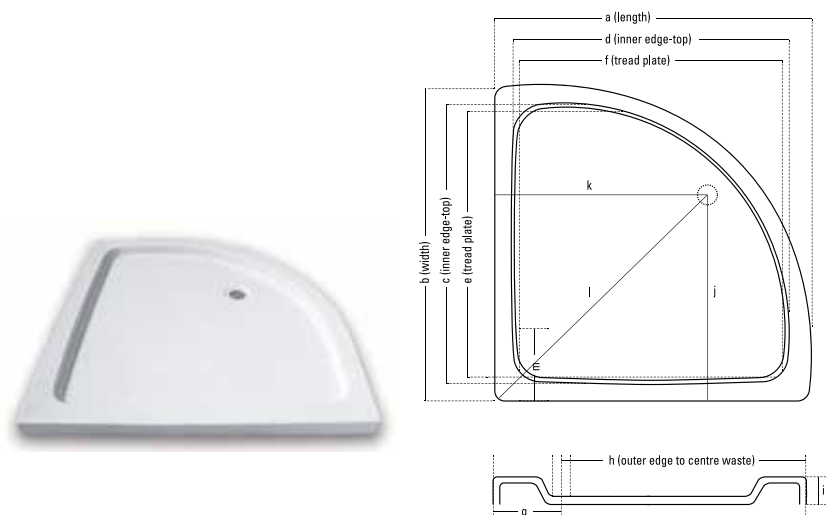

Quadrant Trays

Code	Description	A	B	C	D	E	F	G	H	I	J	VOL	KG	INC VAT	TVA INC
S3371	800 x 800 Quadrant 45mm stone resin tray inc fast flow waste	800	800	695	695	685	685	185	715	45	510	15	17	£198.74	266.31€
S3381	900 x 760 L/H Quadrant 45mm stone resin tray inc fast flow waste	900	760	635	775	610	755	170	785	45	485	17	20	£282.25	378.22€
S3391	900 x 760 R/H Quadrant 45mm stone resin tray inc fast flow waste	900	760	635	775	610	755	170	785	45	485	17	20	£283.43	379.79€
S3401	900 x 900 Quadrant 45mm stone resin tray inc fast flow waste	900	900	800	800	795	795	185	860	45	610	19	23	£202.28	271.05€
S3411	1000 x 1000 Quadrant 45mm stone resin tray inc fast flow waste	1000	1000	880	880	865	865	170	1020	45	725	22	40	£370.45	496.41€
S3421	1000 x 800 L/H Quadrant 45mm stone resin tray inc fast flow waste	1000	800	670	1070	660	1060	145	1070	45	535	19	24	£314.01	420.77€
S3431	1000 x 800 R/H Quadrant 45mm stone resin tray inc fast flow waste	1000	800	670	1070	660	1060	145	1070	45	535	19	24	£314.01	420.77€
S3441	1200 x 800 L/H Quadrant 45mm stone resin tray inc fast flow waste	1200	800	790	1090	780	1080	145	1120	45	630	22	30	£335.18	449.14€
S3451	1200 x 800 R/H Quadrant 45mm stone resin tray inc fast flow waste	1200	800	790	1090	780	1080	145	1120	45	630	22	30	£335.18	449.14€
S3461	1200 x 900 L/H Quadrant 45mm stone resin tray inc fast flow waste	1200	900	685	885	675	875	145	910	45	610	25	32	£350.45	469.61€
S3471	1200 x 900 R/H Quadrant 45mm stone resin tray inc fast flow waste	1200	900	685	885	675	875	145	910	45	610	25	32	£350.45	469.61€

Fitting Kits

Code	Description	INC VAT	€	S6161	Rectangle Fitting Kit 1100 x 900	£167.84		S6331	Rectangle Fitting Kit 1700 x 700	£226.08	
S6011	Square Fitting Kit 760 x 760	£137.00		S6171	Rectangle Fitting Kit 1200 x 700	£157.57		S6341	Rectangle Fitting Kit 1700 x 760	£227.21	
S6021	Square Fitting Kit 800 x 800	£138.15		S6181	Rectangle Fitting Kit 1200 x 760	£158.70		S6351	Rectangle Fitting Kit 1700 x 800	£234.06	
S6031	Square Fitting Kit 900 x 900	£139.30		S6191	Rectangle Fitting Kit 1200 x 800	£158.70		S6361	Rectangle Fitting Kit 1700 x 900	£235.21	
S6041	Square Fitting Kit 1000 x 1000	£171.27		S6201	Rectangle Fitting Kit 1200 x 900	£165.55		S6371	Quadrant Fitting Kit 800 x 800	£132.45	
S6051	Rectangle Fitting Kit 800 x 700	£148.43		S6211	Rectangle Fitting Kit 1400 x 700	£205.52		S6381	Quadrant Fitting Kit 900 x 760 L/H	£153.00	
S6061	Rectangle Fitting Kit 900 x 700	£148.43		S6221	Rectangle Fitting Kit 1400 x 760	£210.08		S6391	Quadrant Fitting Kit 900 x 760 R/H	£154.14	
S6071	Rectangle Fitting Kit 900 x 760	£149.58		S6231	Rectangle Fitting Kit 1400 x 800	£226.08		S6401	Quadrant Fitting Kit 900 x 900	£138.15	
S6081	Rectangle Fitting Kit 900 x 800	£149.58		S6241	Rectangle Fitting Kit 1400 x 900	£228.36		S6411	Quadrant Fitting Kit 1000 x 800 L/H	£157.57	
S6091	Rectangle Fitting Kit 1000 x 700	£155.28		S6251	Rectangle Fitting Kit 1500 x 700	£205.52		S6421	Quadrant Fitting Kit 1000 x 800 R/H	£157.57	
S6101	Rectangle Fitting Kit 1000 x 760	£156.43		S6261	Rectangle Fitting Kit 1500 x 760	£207.81		S6431	Quadrant Fitting Kit 1000 x 1000	£157.57	
S6111	Rectangle Fitting Kit 1000 x 800	£157.57		S6271	Rectangle Fitting Kit 1500 x 800	£228.36		S6441	Quadrant Fitting Kit 1200 x 800 L/H	£175.83	
S6121	Rectangle Fitting Kit 1000 x 900	£158.70		S6281	Rectangle Fitting Kit 1500 x 900	£229.50		S6451	Quadrant Fitting Kit 1200 x 800 R/H	£175.83	
S6131	Rectangle Fitting Kit 1100 x 700	£172.41		S6301	Rectangle Fitting Kit 1600 x 760	£215.79		S6461	Quadrant Fitting Kit 1200 x 900 L/H	£195.25	
S6141	Rectangle Fitting Kit 1100 x 760	£173.56		S6311	Rectangle Fitting Kit 1600 x 800	£228.36		S6471	Quadrant Fitting Kit 1200 x 900 R/H	£195.25	
S6151	Rectangle Fitting Kit 1100 x 800	£174.70		S6321	Rectangle Fitting Kit 1600 x 900	£230.64					

Trayed Secret – shower tray fixing kit

Trayed Secret - Kit de fixation pour receveurs de douche

Trayed Secret is a revolutionary universal fixing kit for all types of stone resin shower trays. Suitable for all our Resin shower trays. The quick and easy plumbing solution for any professional or DIY fitting application.

Le système Trayed Secret est un kit de fixation universel et révolutionnaire destiné à tous les types de receveurs de douche en résine de pierre. Ce kit est adapté à tous nos receveurs de douche en résine. Il s'agit d'une solution simple et rapide destinée à n'importe quel professionnel ou toute personne souhaitant installer un receveur.



1. Complete plumbing work area.
1. Procédez aux travaux de plomberie.



2. Fit legs to Trayed Secret system.
2. Fixez les pieds au système Trayed Secret.



3. Place the Trayed Secret system into position.
3. Placez correctement le système Trayed Secret.



4. Finish tiling and use the Trayed Secret system as a working platform.

4. Terminez de poser le carrelage et utilisez le système Trayed Secret comme plate-forme de travail.



5. Mix bedding sand and cement (included in kit) on the Trayed Secret base.

5. Mélangez le sable et le ciment (inclus dans le kit) sur la base du système Trayed Secret.



6. Fit tiling upstand kit, shower tray and removable side panel(s).

6. Installez le /// kit de rehausse, le receveur de douche et la/les paroi(s) latérale(s) amovible(s).

- Assembles in minutes, saving hours of fitting time. No need to plumb waste pipes under the floor.
- Un assemblage en quelques minutes, permettant ainsi d'économiser des heures de travail. Il n'est pas nécessaire d'installer des tuyaux d'évacuation sous le sol
- Acts as a convenient work platform and prevents damage to the tray prior to installation.
- Un système qui fait office de plate-forme de travail et évite d'endommager le receveur avant son installation.
- High quality, strong and durable. Suitable for heavy loads.
- Un système de haute qualité, solide et durable. Adapté aux charges lourdes

- Suitable for all floor surfaces.
- Un système adapté à tous les revêtements de sol.
- Provides quick and easy access to waste and plumbing after installation.
- Un système qui offre un accès simple et rapide aux tuyaux d'évacuation et à la plomberie une fois l'installation terminée
- Enables pre-plumbing of the bathroom prior to fitting the shower tray.
- Un système qui permet de pré-installer la plomberie de la salle de bains avant d'installer le receveur de douche
- Raise tray 90mm – 120mm from the floor surface.
- Un système qui permet de placer le receveur à 90-120 mm du sol.

The kit contains

Contenu du kit :

- High quality, heavy duty pre-cut plinth, incorporating all fittings.
- une plinthe prédécoupée de haute qualité et ultra-résistante, intégrant tous les raccords ;
- Fully adjustable rugged steel leg system.
- des pieds en acier robuste et réglables ;
- 50mm and 90mm waste templates.
- des /// de 50 et 90 mm ;
- Pre-formed white acrylic capped ABS panels.
- des parois ABS en acrylique de couleur blanche pré-formées ;
- Panel clip kit.
- un kit de fixation des parois ;
- Tiling 'Upstand Kit' for watertight fit around shower tray.
- un /// kit de rehausse garantissant une étanchéité autour du receveur ;
- Shower tray bedding adhesive.
- de la colle pour fixer le receveur.

SHOWER ZONE



SHOWER PACKAGES

1 Water Outlet

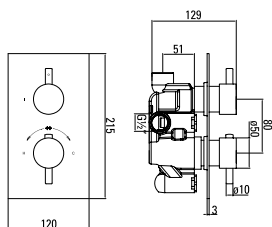

1 Water Outlet

CODE **DESCRIPTION**
CP060 Cos 1 outlet concealed thermostatic valve
 Round slide rail kit with built in water outlet

INC VAT **TVA INC**
 £446.40 598.18€

Made up of S1007 & C0019

1 Water Outlet

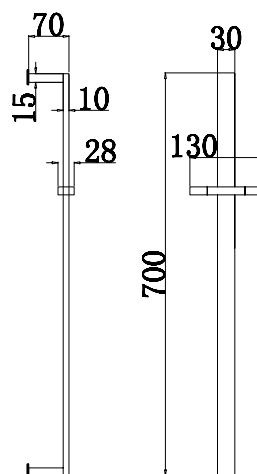

1 Water Outlet

CODE **DESCRIPTION**
TP060 Tooga 1 outlet concealed thermostatic valve
 Square slide rail kit with outlet elbow

INC VAT **TVA INC**
 £514.40 689.29€

Made up of S1004 & T0019

1 Water Outlet

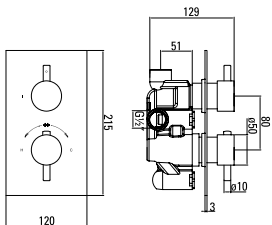
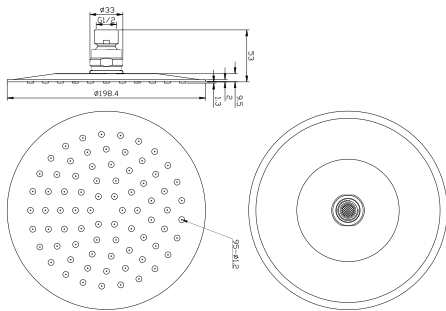

1 Water Outlet

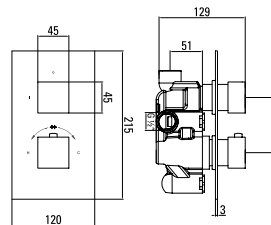
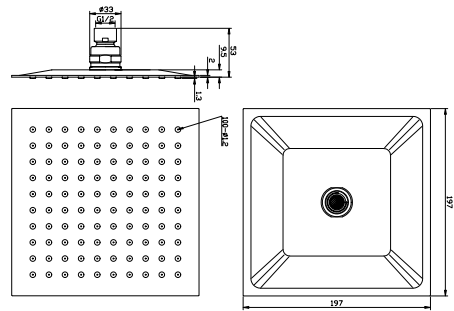

1 Water Outlet

CODE **DESCRIPTION**
CP061 Cos 1 outlet concealed thermostatic valve
 Round fixed head including wall arm

INC VAT **TVA INC**
 £535.45 717.50€

Made up of C0024, S1010 & C0019

1 Water Outlet

CODE **DESCRIPTION**
TP061 Tooga 1 outlet concealed thermostatic valve
 Square fixed head including wall arm

INC VAT **TVA INC**
 £565.42 757.66€

Made up of T0024, UN003 & T0019

2 Water Outlet

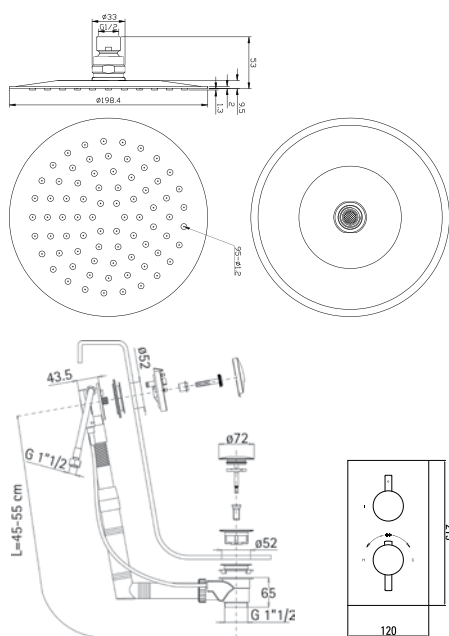

2 Water Outlet

CODE **DESCRIPTION**
CP062 Cos 2 outlet concealed thermostatic shower valve
 Round fixed shower head and wall arm
 Jollysluice bath filler, overflow and pop up waste

Made up of C0024, S1010, AC117 & C0020

INC VAT **TVA INC**
 £739.82 991.36€

2 Water Outlet

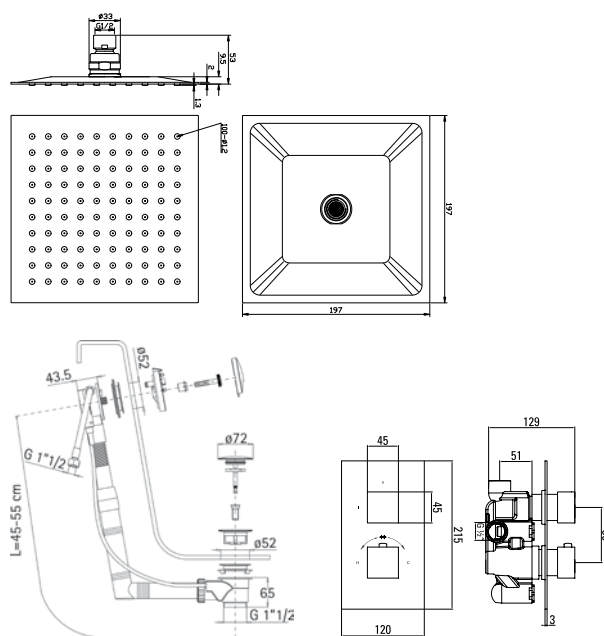

2 Water Outlet

CODE **DESCRIPTION**
TP062 Tooga 2 outlet concealed thermostatic shower valve.
 Square fixed shower head and wall arm
 Jollysluice bath filler, overflow and pop up waste

Made up of T0024, UN003, AC117 & T0020

INC VAT **TVA INC**
 £762.67 1021.97€

2 Water Outlet

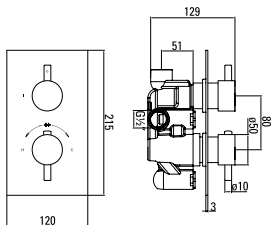
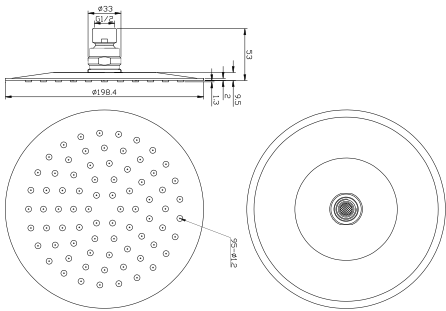

2 Water Outlet

CODE	DESCRIPTION	INC VAT	TVA INC
CP063	Cos 2 outlet concealed thermostatic shower valve Round fixed shower head and wall arm Round handspray kit including hose, handset and holder	£677.46	907.80€

Made up of CO024, S1010, S1060 & CO020

2 Water Outlet

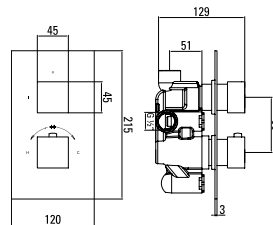
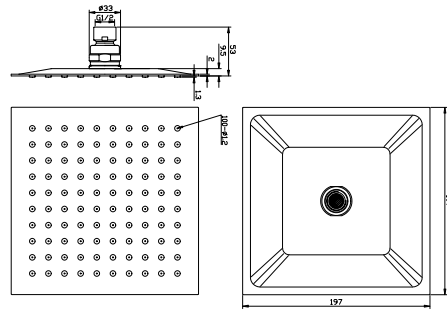

2 Water Outlet

CODE	DESCRIPTION	INC VAT	TVA INC
TP063	Tooga 2 outlet concealed thermostatic shower valve. Square fixed shower head and wall arm Square handspray kit including hose, handset and holder	£725.57	972.26€

Made up of TO024, UN003, S1064 & TO020

2 Water Outlet



2 Water Outlet

CODE	DESCRIPTION	INC VAT	TVA INC
CP064	Cos 2 outlet concealed thermostatic shower valve Round fixed shower head and wall arm Round slide rail kit with built in water outlet	£680.62	912.03€
Made up of C0024, S1010, S1005 & C0020			

2 Water Outlet



2 Water Outlet

CODE	DESCRIPTION	INC VAT	TVA INC
TP064	Tooga 2 outlet concealed thermostatic shower valve Square fixed shower head and wall arm Square slide rail kit with outlet elbow	£745.57	999.06€
Made up of T0024, UN003, S1004 & T0020			

2 Water Outlet

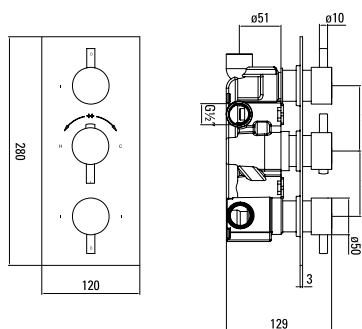
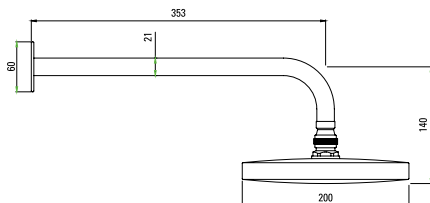

2 Water Outlet

CODE	DESCRIPTION	INC VAT	TVA INC
CP071	Cos 2 outlet concealed thermostatic shower valve Round fixed shower head and wall arm Round handspray kit including hose, handset and holder	£742.66	995.16€

Made up of C0022, S1010, C0024, S1025, S1032 & S1042

2 Water Outlet

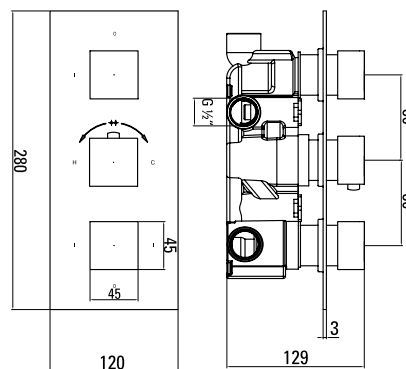

2 Water Outlet

CODE	DESCRIPTION	INC VAT	TVA INC
TP071	Cos 2 outlet concealed thermostatic shower valve Round fixed shower head and wall arm Round handspray kit including hose, handset and holder	£742.66	995.16€

Made up of T0022, UN003, T0024, S1026, S1032 & S1043

2 Water Outlet

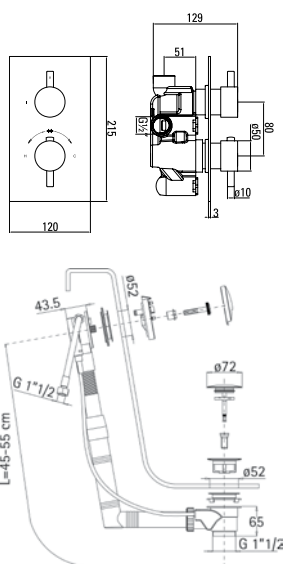

2 Water Outlet

CODE	DESCRIPTION	INC VAT	TVA INC
CP065	Cos 2 outlet concealed thermostatic shower valve Round handspray kit including hose, handset and holder Jollysluice bath filler, overflow and pop up waste	£610.39	817.93€

Made up of S1060, AC117 & C0020

2 Water Outlet

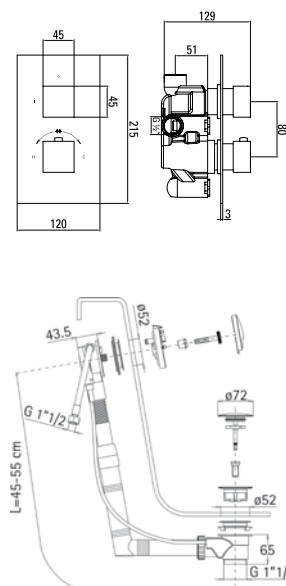

2 Water Outlet

CODE	DESCRIPTION	INC VAT	TVA INC
TP065	Tooga 2 outlet concealed thermostatic shower valve Square handspray kit including hose, handset and holder Jollysluice bath filler, overflow and pop up waste	£680.62	912.03€

Made up of S1064, AC117 & T0020

2 Water Outlet

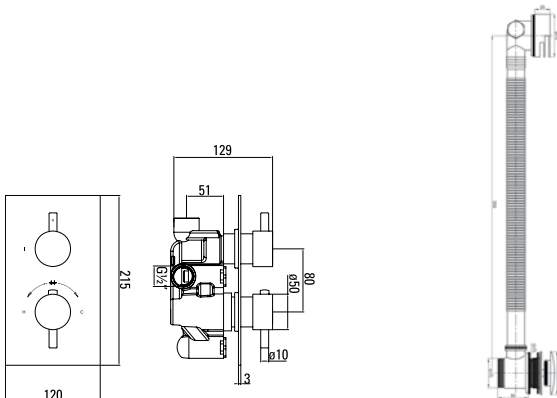

2 Water Outlet

CODE	DESCRIPTION	INC VAT	TVA INC
CP175	Cos 2 outlet concealed thermostatic shower valve Round pencil pullout handset, bath shroud & hose Cos bath filler, overflow & clicker waste	£555.44	744.29€
Made up of C0016, C0100 & C0020			

2 Water Outlet

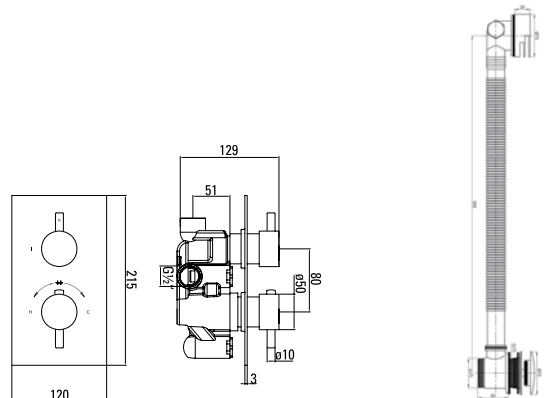

2 Water Outlet

CODE	DESCRIPTION	INC VAT	TVA INC
CP176	Cos 2 outlet concealed thermostatic shower valve Round 5-function pullout handset, bath shroud & hose Cos bath filler, overflow & clicker waste	£594.64	796.82€
Made up of C0017, C0100 & C0020			

2 Water Outlet

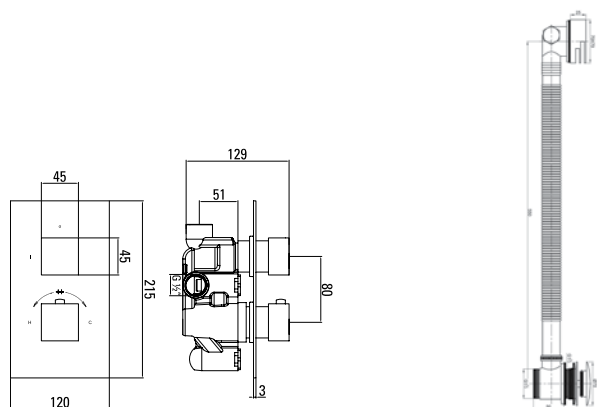

2 Water Outlet

CODE	DESCRIPTION	INC VAT	TVA INC
TP176	Tooga 2 outlet concealed thermostatic shower valve Square pullout handset, bath shroud & hose Tooga bath filler, overflow & clicker waste	£505.00	676.69€
Made up of T0016, T0100 & T0020			



Cos C0016 Round pencil pullout handset, bath shroud & hose



Cos C0017 Round 5-function pullout handset, bath shroud & hose



Tooga T0016 Square pullout handset, bath shroud & hose

2 Water Outlet

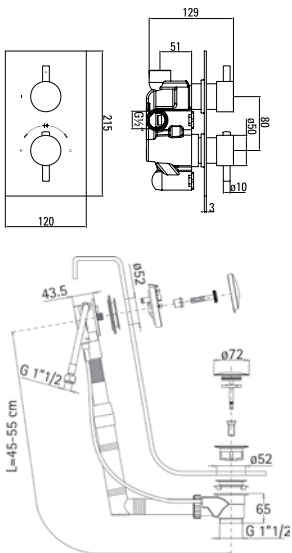

2 Water Outlet

CODE	DESCRIPTION	INC VAT	TVA INC
CP066	Cos 2 outlet concealed thermostatic shower valve Round slide rail kit with built in water outlet Jollysluice bath filler, overflow and pop up waste	£645.66	865.18€
Made up of S1007, AC117 & CO020			

2 Water Outlet

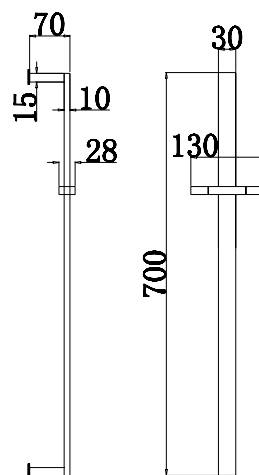

2 Water Outlet

CODE	DESCRIPTION	INC VAT	TVA INC
TP066	Tooga 2 outlet concealed thermostatic shower valve Square slide rail kit with outlet elbow Jollysluice bath filler, overflow and clicker waste	£641.54	859.66€
Made up of S1004, T0100 & T0020			

3 Water Outlet



3 Water Outlet

CODE	DESCRIPTION	INC VAT	TVA INC
CP068	Cos 3 outlet concealed thermostatic shower valve Round fixed shower head including wall arm Round handspray kit including hose, handset and holder Jollysluice bath filler, overflow and pop up waste	£968.46	1297.73€
Made up of C0024, S1010, S1060, AC117 & C0021			

3 Water Outlet



3 Water Outlet

CODE	DESCRIPTION	INC VAT	TVA INC
TP068	Tooga 3 outlet concealed thermostatic shower valve Square fixed shower head including wall arm Square handspray kit including hose, handset and holder Jollysluice bath filler, overflow and pop up waste	£946.02	1267.67€
Made up of T0024, UN003, S1064, AC117 & T0021			

3 Water Outlet

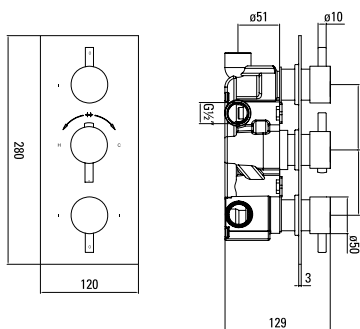
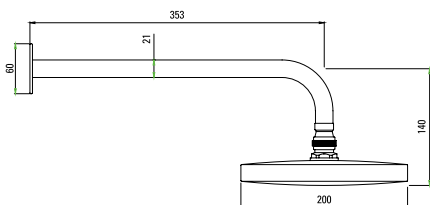

3 Water Outlet

CODE	DESCRIPTION	INC VAT	TVA INC
CP070	Cos 3 outlet concealed thermostatic shower valve Round fixed shower head including wall arm Round handspray kit including hose, handset and holder Round body jets including swivel head x 4	£895.73	1200.28€

Made up of C0024, S1010, S1060, S1018 x 4 & C0021

3 Water Outlet

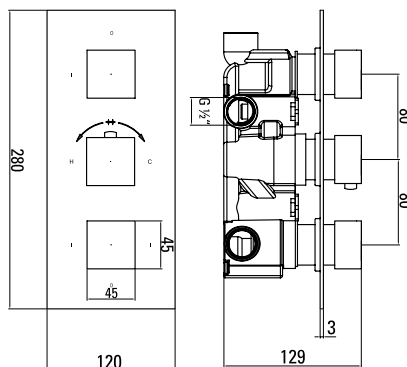

3 Water Outlet

CODE	DESCRIPTION	INC VAT	TVA INC
TP070	Tooga 3 outlet concealed thermostatic shower valve Square fixed shower head including wall arm Square handspray kit including hose, handset and holder Square body jets including swivel head x 4	£946.89	1268.83€

Made up of T0024, UN003, S1064, S1019 x 4 & T0021

SHOWER & ACCESSORIES



Shower



CODE
S1009
AC006

DESCRIPTION
Round side rail kit c/w hose and five function head
Round outlet elbow

INC VAT **TVA INC**
£148.82 199.42€
£34.62 46.38€

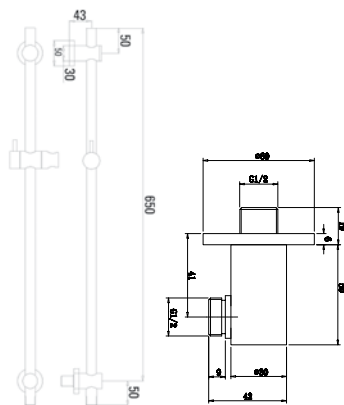

CODE
S1007

DESCRIPTION
Round slide rail kit c/w hose and five function head,
concealed outlet

INC VAT **TVA INC**
£117.68 157.70€

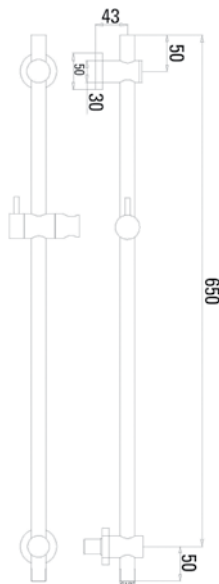

CODE
S1008
AC006

DESCRIPTION
Round side rail kit c/w hose and handset
Round outlet elbow

INC VAT **TVA INC**
£125.75 168.51€
£34.62 46.38€

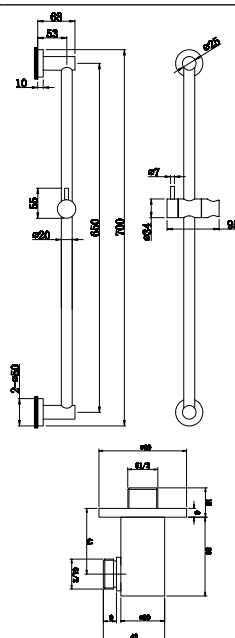

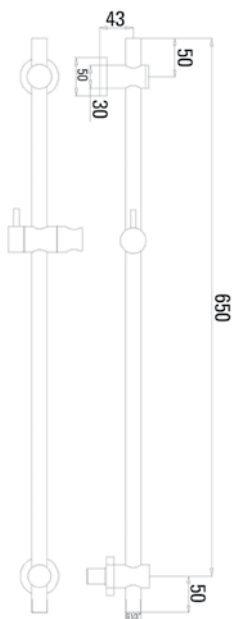

CODE
S1005

DESCRIPTION
65cm slide rail kit with monofunction head
with concealed outlet

INC VAT **TVA INC**
£117.68 157.70€

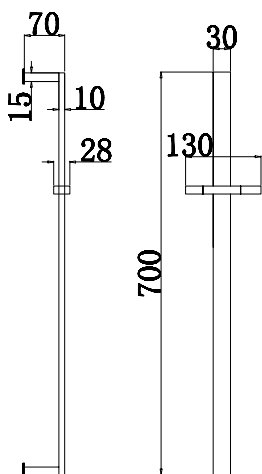

CODE
S1004

DESCRIPTION
Square side rail kit c/w hose and handset,
includes outlet elbow

INC VAT **TVA INC**
£160.36 214.88€

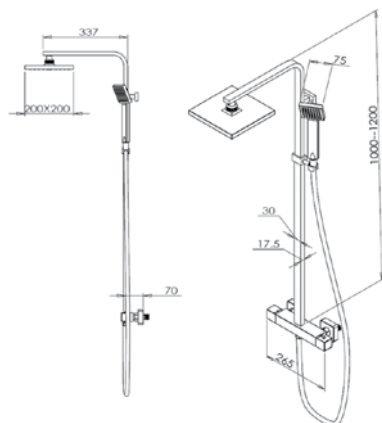

DESCRIPTION
Thermostatic rigid riser inc. overhead & handset

INC VAT **TVA INC**
£398.18 533.57€



Shower . . .



CODE
CO035

DESCRIPTION
Thermostatic rigid riser inc. overhead & handset

INC VAT £332.83
TVA INC 446.00€

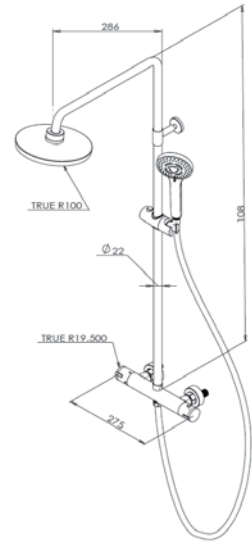

CODE
TO024
UN003

DESCRIPTION
Tooga ultra slim rain shower head – 200mm
Wall-mounted shower arm, square
Total

INC VAT £152.84
£73.83
£226.67

TVA INC 204.81€
98.93€
303.74€

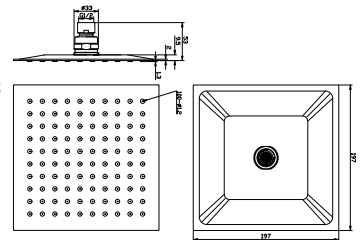

CODE
CO024
S1010

DESCRIPTION
Cos ultra slim rain shower head – 200mm
Wall-mounted shower arm, round
Total

INC VAT £141.94
£71.53
£213.47

TVA INC 190.20€
95.86€
286.06€

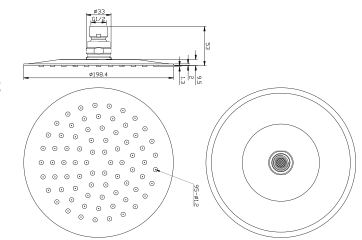

DESCRIPTION
SLIM square shower head – 240mm
Wall mounted 400mm shower arm, square
Total

INC VAT £264.19
£126.91
£391.10

TVA INC 354.01€
170.06€
524.07€

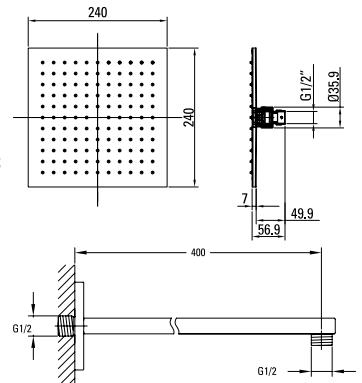

DESCRIPTION
SLIM square shower head – 300mm
Wall mounted 400mm shower arm, square
Total

INC VAT £317.28
£126.91
£444.19

TVA INC 425.15€
170.06€
595.21€

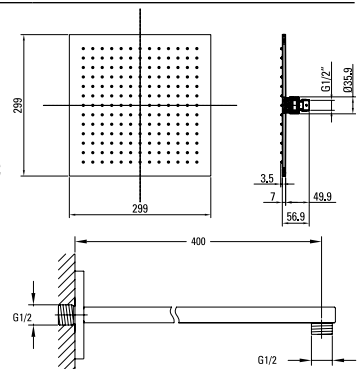

Let it flow . . .
our shower heads will give you fantastic showering and save water at the same time! For the Eco minded people – this is your choice

Laissez couler . . .
Nos pommes de douche vous offriront un agréable moment tout en réduisant votre consommation d'eau ! La solution idéale pour les personnes qui ont la fibre écologique.

WOW!

WOW!

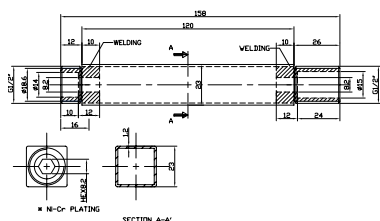

CODE S1013

DESCRIPTION
Ceiling mounted shower arm 120mm – square

INC VAT £68.07
TVA INC 91.22€



CODE UN004

DESCRIPTION
Ceiling mounted shower arm 200mm – square

INC VAT £54.23
TVA INC 72.67€

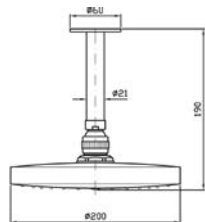

CODE S1020

DESCRIPTION
Ceiling mounted shower arm 200mm – round
*doesn't include shower head

INC VAT £54.23
TVA INC 72.67€

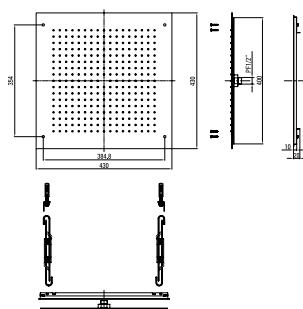

CODE S1078

DESCRIPTION
SLIM 430 x 430mm shower head flush to ceiling

INC VAT £669.14
TVA INC 896.65€

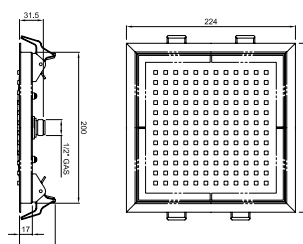

CODE S1022

DESCRIPTION
224 x 224mm built-in shower head
Four clips secure level with ceiling

INC VAT £738.36
TVA INC 989.40€

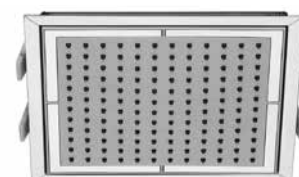

Shower . . .



CODE	DESCRIPTION	INC VAT	TVA INC
S1060	Brass pencil handset inc 1.5m smooth hose and outlet elbow / handset holder	£121.13	162.32€
S1061	Plastic pencil handset inc 1.5m smooth hose and outlet elbow / handset holder	£99.22	132.96€



CODE	DESCRIPTION	INC VAT	TVA INC
S1064	Brass square handset inc 1.5m smooth hose and square outlet elbow / handset holder	£136.13	182.41€



CODE	DESCRIPTION	INC VAT	TVA INC
S1063	Single function handset inc 1.5m smooth hose and outlet elbow / handset holder	£124.60	166.96€



CODE	DESCRIPTION	INC VAT	TVA INC
S1062	Brass pencil handset inc 1.5m smooth hose and square outlet elbow / handset holder	£129.20	173.13€
S1065	Plastic round handset inc 1.5m smooth hose and square outlet elbow / handset holder	£129.20	173.13€

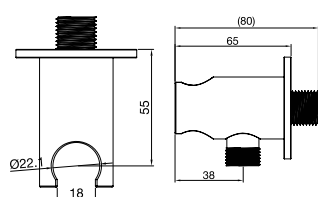

CODE
S1025

DESCRIPTION
Outlet elbow and handset holder – round

INC VAT £58.84
TVA INC 78.85€

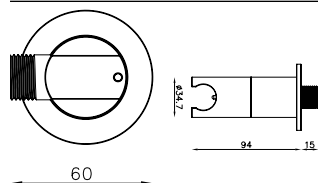

CODE
S1027

DESCRIPTION
Outlet elbow and holder with stopcock – round

INC VAT £111.90
TVA INC 149.95€

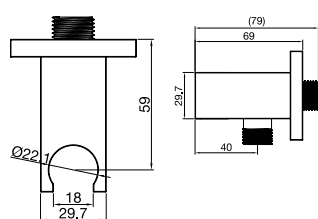

CODE
S1026

DESCRIPTION
Outlet elbow and holder – square

INC VAT £64.61
TVA INC 86.58€

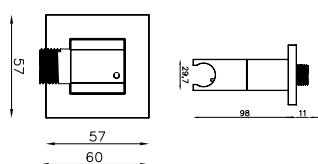
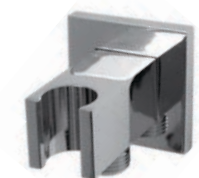

CODE
S1029

DESCRIPTION
Outlet elbow and holder with stopcock – square

INC VAT £126.91
TVA INC 170.06€



CODE
AC091

DESCRIPTION
Outlet elbow with built-in ½ stopcock

INC VAT £69.22
TVA INC 92.75€



CODE
S1034

DESCRIPTION
LP braided metal shower hose 1.5m

INC VAT £19.62
TVA INC 26.29€



CODE
S1031

DESCRIPTION
LP braided metal shower hose 2m

INC VAT £18.46
TVA INC 24.74€



CODE
S1032

DESCRIPTION
Smooth shower hose 1.5m

INC VAT £17.30
TVA INC 23.18€



CODE
S1033

DESCRIPTION
Smooth shower hose 2m

INC VAT £18.46
TVA INC 24.74€



Shower . . .



CODE
S1040

DESCRIPTION
Round plastic pencil head

INC VAT
£19.62

TVA INC
26.29€



CODE
S1042

DESCRIPTION
Round brass pencil head

INC VAT
£38.08

TVA INC
51.02€



CODE
S1041

DESCRIPTION
Square plastic pencil head

INC VAT
£39.22

TVA INC
52.56€



CODE
S1043

DESCRIPTION
Square brass pencil head

INC VAT
£44.99

TVA INC
60.29€



CODE
S1044

DESCRIPTION
Single function round shower head

INC VAT
£25.37

TVA INC
34.00€



CODE
C0018

DESCRIPTION
Pullout shower spray & shroud inc. INDRAIN system

INC VAT
£178.16

TVA INC
238.73€

CODE
S1018

DESCRIPTION
Round brass body jet

INC VAT £38.36
TVA INC 51.40€



CODE
S1019

DESCRIPTION
Square brass body jet

INC VAT £45.63
TVA INC 61.14€

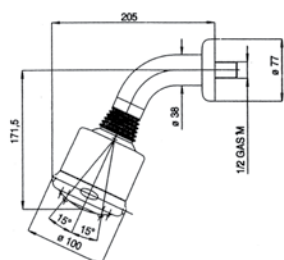

CODE
S09

DESCRIPTION
Luxor varispray fixed shower head

INC VAT £141.91
TVA INC 190.16€

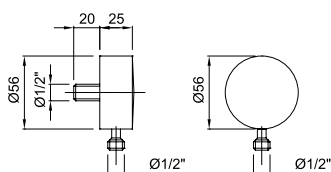

CODE
Z9380P

DESCRIPTION
Outlet elbow

INC VAT £34.62
TVA INC 46.38€



CODE
AC006

DESCRIPTION
Round outlet elbow

INC VAT £34.62
TVA INC 46.38€

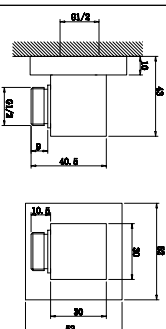

CODE
AC007

DESCRIPTION
Square outlet elbow

INC VAT £40.42
TVA INC 54.16€



DOUCHES



Pictured: S1101 round douche handset including hose and bracket.

**CODE
S1103**

DESCRIPTION
Round douche head – brass
including hose and bracket

INC VAT £95.15
TVA INC 127.50€

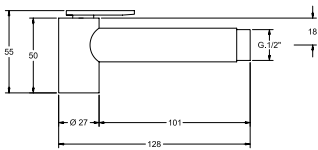

**CODE
S1113**

DESCRIPTION
Round douche head – brass
including hose and stopcock

INC VAT £105.72
TVA INC 141.66€

**For safe water delivery add S1120
thermo balancing valve**

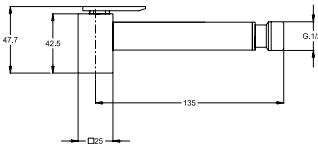

**CODE
S1104**

DESCRIPTION
Square douche head – brass
including hose and bracket

INC VAT £105.87
TVA INC 141.86€



**CODE
S1114**

DESCRIPTION
Square douche head – brass
including hose and stopcock

INC VAT £116.12
TVA INC 155.60€

**For safe water delivery add S1120
thermo balancing valve**



**CODE
S1116**

DESCRIPTION
Douche bracket

INC VAT £10.58
TVA INC 14.18€

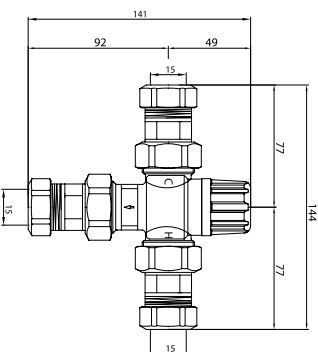
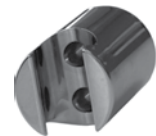

**CODE
S1120**

DESCRIPTION
Thermo balancing valve

INC VAT £76.45
TVA INC 102.44€



All installations must comply with guidelines based on the zonal requirements.

Toutes les installations doivent être conformes aux directives définies en fonction des différentes zones de la salle de bains.

These regulations apply to domestic installations only.

Les présentes réglementations s'appliquent uniquement aux installations domestiques.

We recommend that all electrical work carried out is done by a suitably qualified electrician with the current IEE wiring regulations (17th Edition).

Il est recommandé que les travaux électriques soient réalisés par un électricien dûment qualifié et conformément aux réglementations en matière de câblage de l'IEE (17e édition).

Bathroom lights are classified using an IP (Ingress Protection) rating. The IP characters are followed by 2 numbers which refer to the level of protection against the ingress of foreign bodies (1st number) and protection against the ingress of liquids (2nd number).

Les éclairages de salle de bains sont classés selon leur indice de protection (IP). Les lettres IP sont suivies de deux chiffres qui font référence au niveau de protection contre les intrusions de corps solides (1er chiffre) et de corps liquides (2nd chiffre).

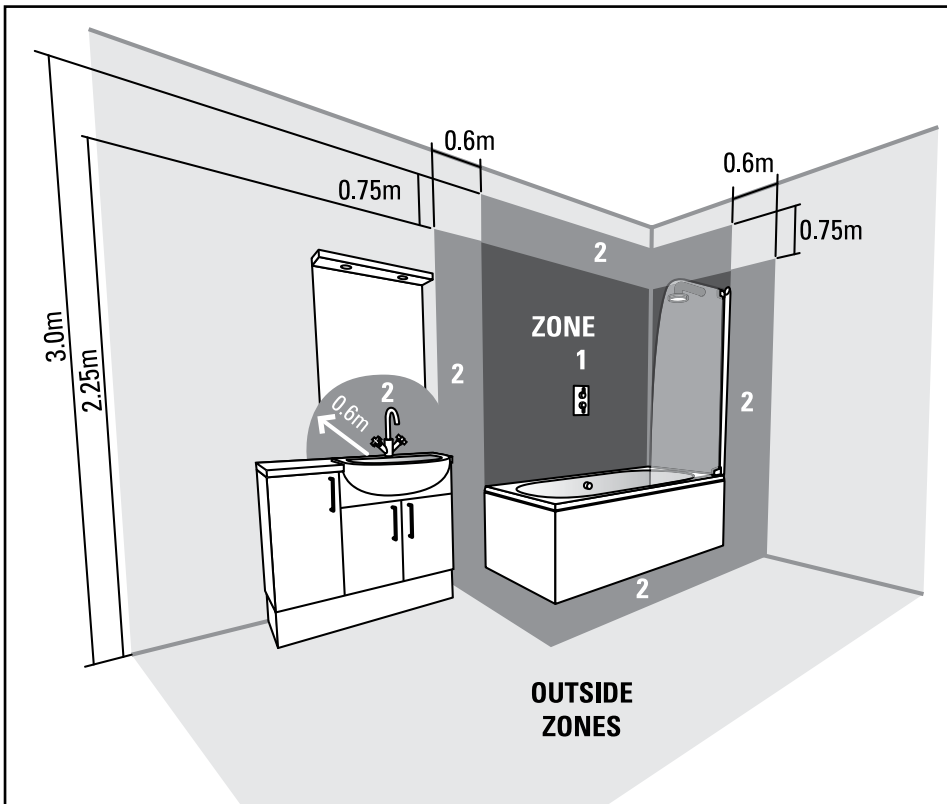

ZONE 0 – is inside the bath or shower. Any fitting used in this zone must be low voltage (max 12v) and be rated at least voltage (max 12v) and be rated at least IP67 (immersion proof)

ZONE 0 – intérieur de la baignoire ou de la douche. Tout appareil utilisé dans cette zone doit être à basse tension (12 V maximum) et classé IP67 minimum (protection contre l'immersion).

ZONE 1 – is an area above the bath to a height of 2.25m from the floor. In this zone a minimum rating of IPX4 is required.

ZONE 1 – correspond à la zone allant jusqu'à 2,25 mètres au-dessus du fond de la baignoire ou de la douche. Dans cette zone, une classification IPX4 minimum est requise.

ZONE 2 – is an area stretching 0.6m outside the perimeter of the bath to a height of 2.25m from the floor. In this zone a minimum of IPX4 is required. Around a wash basin, a radius within 60cm is considered as zone 2.

ZONE 2 – zone qui s'étend jusqu'à 60 cm autour de la baignoire ou de la douche, jusqu'à 2,25 mètres au-dessus du fond. Dans cette zone, une classification IPX4 minimum est requise. Elle correspond également à la zone autour du lavabo, dans un rayon de 60 cm.

OUTSIDE ZONES – has no specific requirements unless water jets are likely to be used for cleaning purposes.

ZONES EXTÉRIEURES – aucune exigence spécifique, sauf s'il est prévu d'utiliser des jets d'eau dans le cadre d'un nettoyage.

ALL ZONES – any electrical circuits in a bathroom must be protected by a 30mA Residual Current Device (RCD). Electrical equipment exposed to water jets such as a shower must be at least IPX5.

ENSEMBLE DES ZONES – tout circuit électrique présent dans la salle de bains doit être protégé à l'aide d'un dispositif différentiel résiduel (DDR) de 30 mA. Les équipements électriques exposés aux jets d'eau (douche, par ex.) requièrent une classification IPX5 minimum.

REFERENCE IP RATINGS FIRST NUMBER – PROTECTION AGAINST SOLIDS

Example	0	1	2	3	4	5	6
Protection against solid foreign objects	No protection	Full Penetration of 50mm diameter sphere allowed. Contact with hazardous parts not permitted	Full Penetration of 12.5mm diameter sphere not allowed. The test finger will have ample clearance from hazardous parts	A 2.5mm diameter probe shall not penetrate	A 2.5mm diameter probe shall not penetrate	Limited ingress of dust permitted (no harmful deposit)	Totally protected against dust
Effective protection from:	Non protection	Back of hand	Finger	Tool	Cable	Cable	Cable

REFERENCE IP RATINGS SECOND NUMBER – PROTECTION AGAINST LIQUIDS

Example	0	1	2	3	4	5	6	7	8
Protection against	No protection	Vertically falling droplets of water	Vertically falling droplets of water with the enclosure tilted 15° from the vertical	Protected against spray to 60° from the vertical. Limited ingress acceptable	Protected against water splashed from all directions. Limited ingress acceptable	Protected against low pressure water jets from all directions. Limited ingress acceptable	Protected against strong jets of water (for use on shipdecks). Limited ingress acceptable	Protected against immersion between 15cm and 1m	Protected against long periods of immersion under pressure
Effective protection from:	Non protection	Vertical dripping	Driving rain	Limited spraying	Splashing from all directions	Hosing jets from all directions	Strong jets from all directions	Temporary immersion	Cable

TEMPUS HEATED TOWEL RAILS

SÈCHE-SERVIETTES TEMPUS

HEATED T RAILS

Very classic, very practical. The clean lines of the attractive Tempus heated towel rail look equally at home in bathrooms, kitchens, cloakrooms, and gyms. An essential addition to your requirements, your towels will be softer and drier than ever . . . The highly polished stainless steel will give long life and yield a far superior BTU output in comparison to chromed rails

Très classique et très pratique. Les lignes épurées du séduisant sèche-serviettes Tempus sont très agréables à regarder, que ce soit dans les salles de bains, les cuisines, les toilettes ou les salles de sport. Vos serviettes n'auront jamais été aussi douces et aussi sèches. . . Sa finition en acier inoxydable poli lui confère une longue durée de vie et permet d'obtenir une valeur BTU (British Thermal Unit) bien supérieure à celle des sèche-serviettes en chrome.

Pictured: Tempus 1210 x 600 heated towel rail & Jones mini wall-hung pan.

TEMPUS HEATED TOWEL RAILS DUAL FUEL

SÈCHE-SERVIETTES MIXTES

'I really like the fact that whatever water system I install I am safe with Tempus towel warmers – besides stainless steel has to be the best lasting material in the bathroom'

Bathroom installer
London

« J'apprécie particulièrement le fait de me sentir en sécurité avec les sèche-serviettes Tempus, et ce, quel que soit le système d'eau que j'installe. De plus, l'acier inoxydable est sans aucun doute le matériau le plus durable de la salle de bains. »

Un installateur de salles de bains, Londres London

Design for maximum efficiency, Tempus towel rails are beautifully constructed from high grade stainless steel. 10 year guarantee on all models against corrosion or leakage.

Built to last a life time.

Conçus pour une efficacité maximale, les sèche-serviettes Tempus sont fabriqués en acier inoxydable de haute qualité. L'ensemble des modèles sont garantis 10 ans contre la corrosion et les fuites.

Nos sèche-serviettes sont conçus pour durer toute une vie.

Pictured: Tempus towel rail.

Tempus Heated Towel Rails

Radiating quality for a lifetime... Tempus towel warmers are all constructed of Stainless Steel providing greater efficiency and free of corrosion over time

Un rayonnement destiné à durer toute une vie... Les sèche-serviettes Tempus sont tous fabriqués en acier inoxydable, garantissant ainsi une meilleure efficacité et empêchant toute corrosion au fil du temps.



HEATED T RAILS

stainless steel towel rail



11

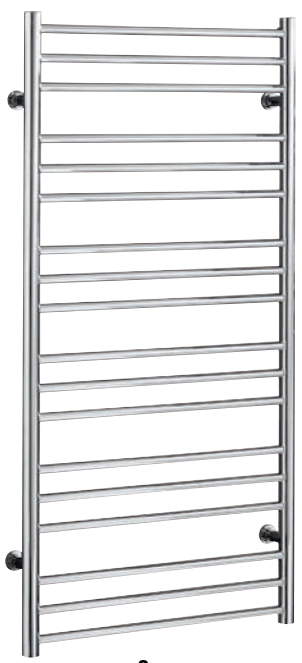

8



4

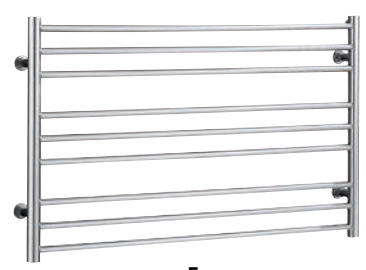

5

	PRODUCT CODE	FIXING HEIGHTS	FIXING CENTRES	HEIGHT X WIDTH	WATTS	BTU	SUMMER ELEMENT	STAINLESS STEEL		
								CODE	INC VAT	€
1	TE-7026	460	265	790 x 300	197	672	150	TE-7026	£288.14	386.10€
2	TE-7036	460	365	790 x 400	215	733	150	TE-7036	£305.77	409.73€
3	TE-7046	460	570	790 x 600	301	1026	150	TE-7046	£363.40	486.96€
4	TE-7056	460	716	790 x 750	346	1180	150	TE-7056	£423.38	567.32€
5	TE-7016	370	965	600 x 1000	352	1200	150	TE-7016	£429.26	575.20€
6	TE-7066	880	365	1210 x 400	329	1122	300	TE-7066	£423.38	567.32€
7	TE-7076	880	470	1210 x 500	397	1345	300	TE-7076	£476.30	638.24€
8	TE-7086	880	570	1210 x 600	458	1462	300	TE-7086	£551.56	739.09€
9	TE-7096	880	716	1210 x 750	531	1811	300	TE-7096	£611.54	819.46€
10	TE-7106	1296	365	1630 x 400	443	1511	300	TE-7106	£699.74	937.65€
11	TE-7116	1296	570	1630 x 600	619	2111	600	TE-7116	£858.50	1150.39€
12	TE-7126	1296	716	1630 x 750	706	2407	600	TE-7126	£987.87	1323.75€

Valves and Accessories for Heated Towel Rails



CODE
VA-1013

DESCRIPTION
Premium Polished **angled** valves (pair)

INC VAT
£82.32

TVA INC
110.31€



CODE
VA-1043

DESCRIPTION
Premium **angled** valves including thermostatic head

INC VAT
£127.02

TVA INC
170.20€



CODE
VA-1023

DESCRIPTION
Premium Polished **straight** valves (pair)

INC VAT
£82.32

TVA INC
110.31€



CODE
VA-1053

DESCRIPTION
Premium **straight** valves including thermostatic head

INC VAT
£127.02

TVA INC
170.02€



CODE
VA-1033

DESCRIPTION
Premium Polished **straight** lockshield & **angled** wheelhead valves for connection to floor used in **dual fuel** situation (pair) Does not include summer element

INC VAT
£82.32

TVA INC
110.31€



CODE
VA-1063

DESCRIPTION
Premium **straight** and **angled** valves including thermostatic head for **dual fuel**

INC VAT
£127.02

TVA INC
170.02€

CODE
VA-3013

DESCRIPTION
Installation pack two tubes, with two shrouds

INC VAT
£49.40

TVA INC
66.19€



CODE
VA-4013

DESCRIPTION
Polished **angled** valves (pair)

INC VAT
£29.40

TVA INC
39.39€



CODE
VA-4023

DESCRIPTION
Polished **straight** valves (pair)

INC VAT
£27.43

TVA INC
36.76€



CODE

DESCRIPTION
Standard Heating Element

VA-2010 150 Watt
VA-2020 300 Watt
VA-2030 600 Watt

INC VAT **TVA INC**

£117.59 157.58€
£127.02 170.20€
£135.24 181.22€



Valves and Accessories for Heated Towel Rails . . .

HEATED T RAILS



CODE	DESCRIPTION	INC VAT	TVA INC
	Temperature Regulating element		
VA-3011	150 Watt	£209.33	280.51€
VA-3023	300 Watt	£223.44	299.41€
VA-3033	600 Watt	£241.08	323.05€



CODE	DESCRIPTION	INC VAT	TVA INC
VA-1093	Element Shroud to suit Standard Element	£47.04	63.03€

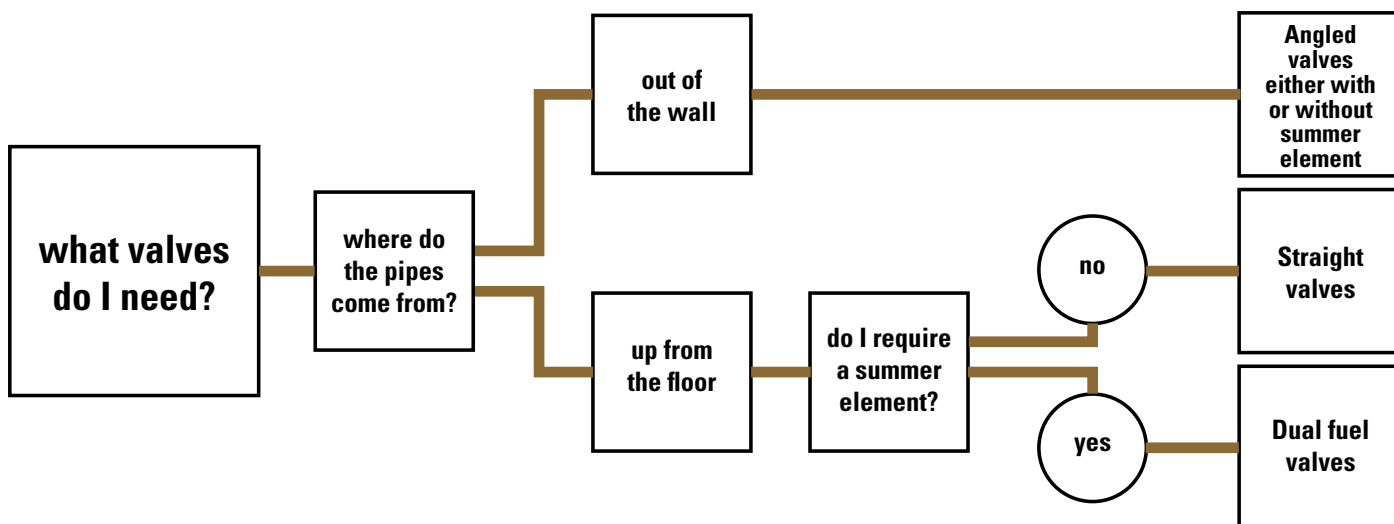

TEMPUS ELECTRIC TOWEL RAILS

SÈCHE-SERVIETTES ÉLECTRIQUES TEMPUS

ELECTRAILS

Efficiency guaranteed...

Our stainless steel electric towel rails are dry element operated for rapid heating and long element life. This makes these towel rails extremely efficient, consuming less power to maintain the same temperatures under a towel.

WOW!

Efficacité garantie...

Nos sèche-serviettes électriques en acier inoxydable offrent un séchage rapide et sont conçus pour durer. Des caractéristiques qui font de ces sèche-serviettes des produits extrêmement efficaces et plus économes en énergie.

WOW!



ELECT RAILS



CODE
TE-7300

DESCRIPTION
1000 x 600 dry electric towel rail switched
240v

INC VAT **TVA INC**
£335.18 449.14€

*stainless steel
towel rail*



CODE
TE-7301

DESCRIPTION
993 x 600 dry electric towel rail switched
240v

INC VAT **TVA INC**
£393.98 527.93€



CODE
TE-7302

DESCRIPTION
1525 x 600 dry electric towel rail switched
240v

INC VAT **TVA INC**
£429.26 575.20€



CODE
TE-7320

DESCRIPTION
1000 x 600 dry electric square towel rail
switched – square
240v

INC VAT **TVA INC**
£376.34 504.29€





CODE
TE-7303

DESCRIPTION
690 x 900 dry electric towel rail switched
240v

INC VAT **TVA INC**
£335.18 449.14€

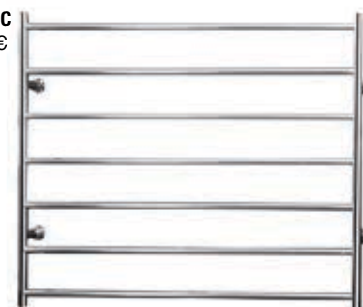

CODE
TE-7304

DESCRIPTION
690 x 1200 dry electric towel rail switched
240v

INC VAT **TVA INC**
£429.26 575.20€

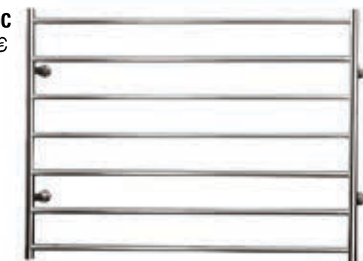

CODE
TE-7305

DESCRIPTION
1000 x 450 dry electric towel rail switched
240v

INC VAT **TVA INC**
£299.89 401.85€



CODE
TE-7306

DESCRIPTION
700 x 600 dry electric towel rail switched
240v

INC VAT **TVA INC**
£270.49 362.46€





ELECTRAILS



CODE
TE-7307

DESCRIPTION
1000 x 600 dry electric towel rail switched
240v

INC VAT **TVA INC**
£335.18 449.14€



CODE
TE-7210

DESCRIPTION
Solo 600 x 80 dry electric towel rail – round
REQUIRES ONE 50VA LIGHTING TRANSFORMER PER RAIL

INC VAT **TVA INC**
£125.00 167.50€



12v



CODE
TE-7212

DESCRIPTION
Solo 600 x 80 x 50 dry electric towel rail – square
REQUIRES ONE 50VA LIGHTING TRANSFORMER PER RAIL

INC VAT **TVA INC**
£145.00 194.30€



CODE
TE-7213

DESCRIPTION
Solo 450 x 80 dry electric towel rail – round
REQUIRES ONE 50VA LIGHTING TRANSFORMER PER RAIL

INC VAT **TVA INC**
£133.56 178.97€

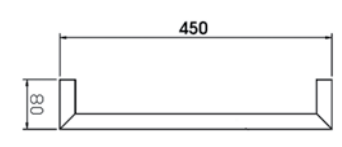

CODE
TE-7214

DESCRIPTION
Solo 450 x 80 x 50 dry electric towel rail – square
REQUIRES ONE 50VA LIGHTING TRANSFORMER PER RAIL

INC VAT **TVA INC**
£148.66 199.20€

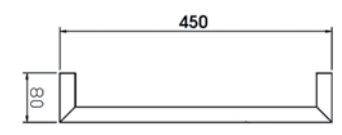

BOTTLE TRAPS AND BASIN WASTES

TRAPS & WASTES



Pictured: Cylindrical bottle-trap 9570. with Podium setup.



CODE
140u

DESCRIPTION
1 ¼" unslotted 'pressflo' waste
for basins without overflow

INC VAT
£48.45

TVA INC
64.93€



CODE
140s

DESCRIPTION
1 ¼" slotted 'pressflo' waste
for basins with overflow

INC VAT
£48.45

TVA INC
64.93€



CODE
530u

DESCRIPTION
1 ¼" unslotted 'clicker' waste
for basins without overflow

INC VAT
£43.84

TVA INC
58.75€



CODE
530s

DESCRIPTION
1 ¼" slotted 'clicker' waste
for basins with overflow

INC VAT
£43.84

TVA INC
58.75€



CODE
9573

DESCRIPTION
Open outlet draining

INC VAT
£44.99

TVA INC
60.29€



CODE
540u

DESCRIPTION
1 ¼" unslotted 'clicker' waste
for basins without overflow

INC VAT
£43.84

TVA INC
58.75€

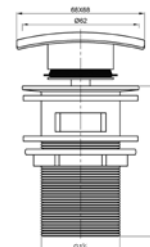

CODE
540s

DESCRIPTION
1 ¼" slotted 'clicker' waste
for basins with overflow

INC VAT
£43.84

TVA INC
58.75€

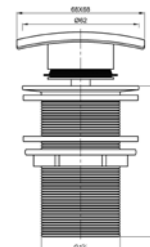

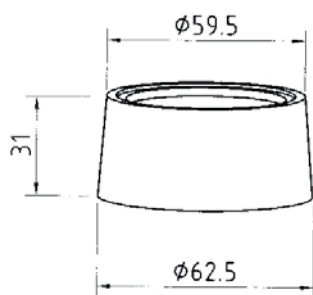

CODE
AC100

DESCRIPTION
Chrome spacer collar
(For basins without overflow)

INC VAT £15.00
TVA INC 20.10€

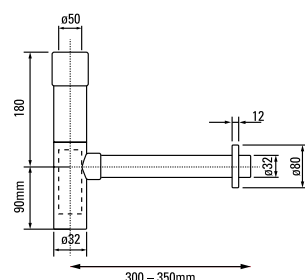

CODE
6061

DESCRIPTION
Luxury cylindrical trap

INC VAT £98.07
TVA INC 131.41€

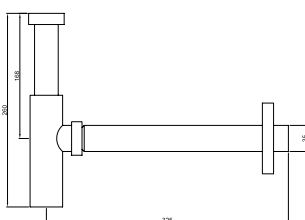

CODE
9570

DESCRIPTION
Cylindrical bottle trap
supplied with 300mm outlet pipe

INC VAT £62.30
TVA INC 83.49€

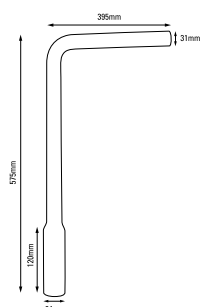

CODE
9560

DESCRIPTION
Cylindrical bottle trap inc. extension pipe

INC VAT £98.07
TVA INC 131.41€

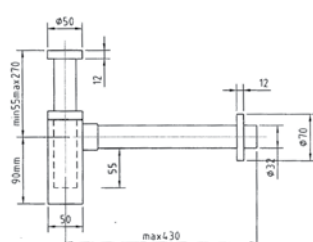

CODE
9574

DESCRIPTION
Picasso square bottle trap

INC VAT £87.68
TVA INC 117.49€



TRAPS & WASTES

That bling thing...
good looks should last. Our accessories are made of brass with a shiny chrome finish granting you a long life of satisfaction

WOW!

ACCESSORIES



ACCESSORIES

Our accessories will match any of our ranges with ease. Can be used domestically or commercially. The super chrome finish will enhance any bathroom.

Nos accessoires conviennent parfaitement à n'importe laquelle de nos gammes. Il est possible d'utiliser ces accessoires dans un cadre aussi bien domestique que commercial. Leur finition chromée mettra en valeur n'importe quelle salle de bains.

Pictured: Jones toilet brush & holder J0310.

CODE
J02285

DESCRIPTION
Soapdish

INC VAT
£47.56

TVA INC
63.73€



CODE
J02190

DESCRIPTION
Glass and holder

INC VAT
£25.16

TVA INC
33.71€



CODE
J02262

DESCRIPTION
Soap dispenser

INC VAT
£33.89

TVA INC
45.41€



CODE
J02385

DESCRIPTION
Shelf

INC VAT
£36.00

TVA INC
48.24€



CODE
J02310

DESCRIPTION
Pair of hooks

INC VAT
£60.24

TVA INC
80.72€



CODE
J02140

DESCRIPTION
Towel rail 48cm

INC VAT
£79.99

TVA INC
107.18€



Accessories Quadro



CODE
QU281

DESCRIPTION
Soapdish

INC VAT £51.92
TVA INC 69.57€

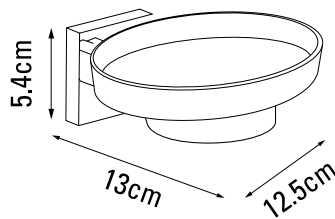

CODE
QU285

DESCRIPTION
Soap holder

INC VAT £66.91
TVA INC 89.66€

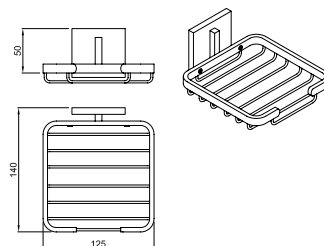

CODE
QU280

DESCRIPTION
Glass and holder

INC VAT £51.92
TVA INC 69.57€

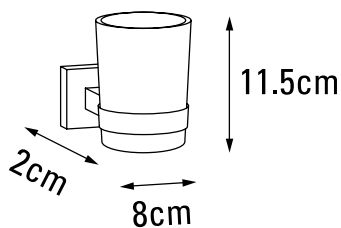

CODE
QU390

DESCRIPTION
Glass shelf

INC VAT £86.53
TVA INC 115.95€

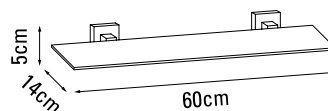

CODE
QU140

DESCRIPTION
Towel rail 30cm

INC VAT £63.45
TVA INC 85.02€

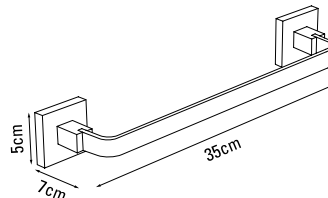

CODE
QU141

DESCRIPTION
Towel rail 56cm

INC VAT £75.00
TVA INC 100.50€

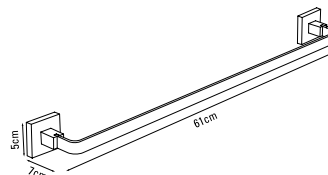

ACCESSORIES

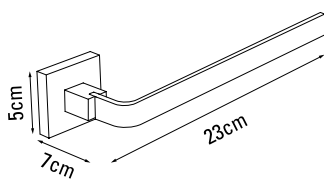

CODE
QU282

DESCRIPTION
Flannel rail 23cm

INC VAT **TVA INC**
£51.92 69.57€

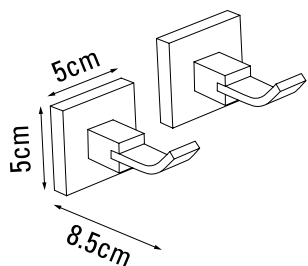

CODE
QU190

DESCRIPTION
Pair of hooks

INC VAT **TVA INC**
£51.92 69.57€

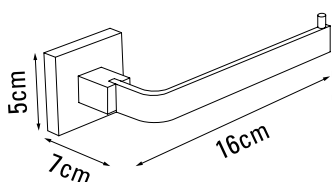

CODE
QU262

DESCRIPTION
Toilet roll holder

INC VAT **TVA INC**
£51.92 69.57€

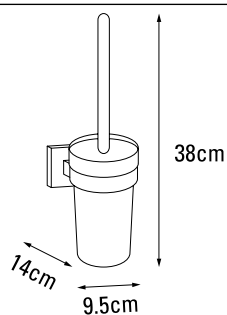

CODE
QU310

DESCRIPTION
Toilet brush & holder











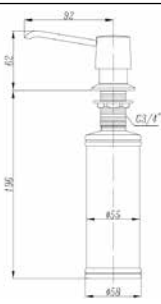

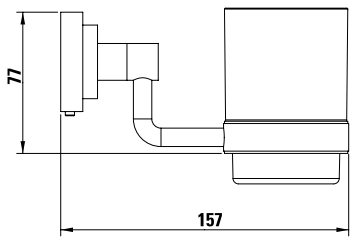
INC VAT **TVA INC**
£86.53 115.95€

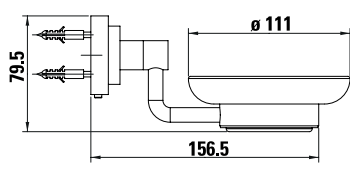

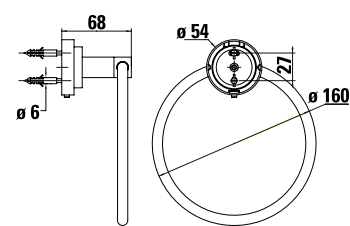
ACCESSORIES

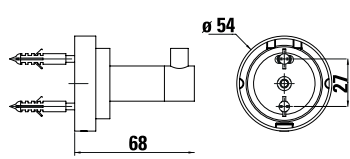
Accessories Tempus

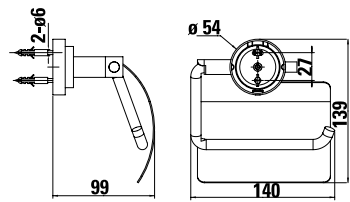
ACCESSORIES

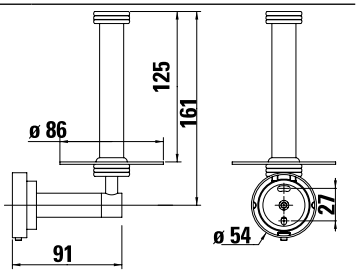
	CODE AC120	DESCRIPTION Deck-mounted soap dispenser	INC VAT £46.15	TVA INC 61.84€	
	CODE TA230	DESCRIPTION Glass and holder	INC VAT £47.31	TVA INC 63.39€	
	CODE TA280	DESCRIPTION Soapdish	INC VAT £47.31	TVA INC 63.39€	
	CODE TA150	DESCRIPTION Towel ring	INC VAT £51.92	TVA INC 69.57€	
	CODE TA190	DESCRIPTION Robe hook	INC VAT £38.08	TVA INC 51.02€	
	CODE TA260	DESCRIPTION Toilet roll holder	INC VAT £59.99	TVA INC 80.38€	
	CODE TA261	DESCRIPTION Spare roll holder	INC VAT £73.83	TVA INC 98.93€	

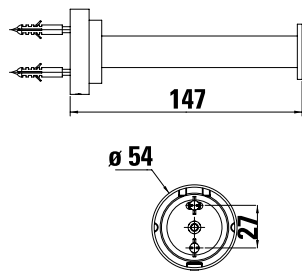

CODE
TA262

DESCRIPTION
Open toilet roll holder

INC VAT £38.08
TVA INC 51.02€

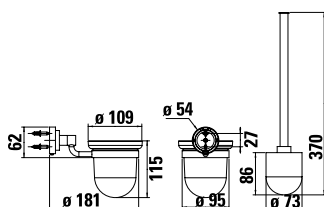

CODE
TA310

DESCRIPTION
Toilet brush & holder

INC VAT £73.07
TVA INC 97.92€

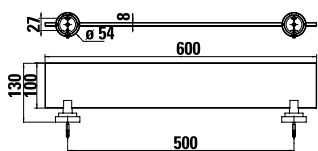

CODE
TA390

DESCRIPTION
Glass shelf 60cm

INC VAT £76.14
TVA INC 102.03€



CODE
TA140

DESCRIPTION
Towel rail 60cm

INC VAT £76.14
TVA INC 102.03€

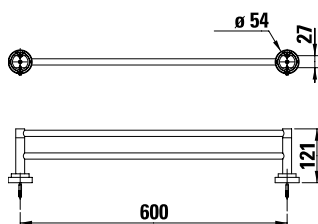

CODE
TA141

DESCRIPTION
Double towel rail 60cm

INC VAT £96.91
TVA INC 129.86€

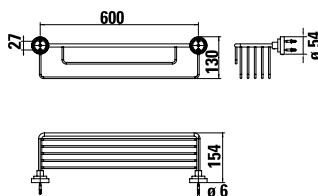

CODE
TA360

DESCRIPTION
Soap 'n' sponge basket 60cm – extra deep

INC VAT £167.28
TVA INC 224.16€

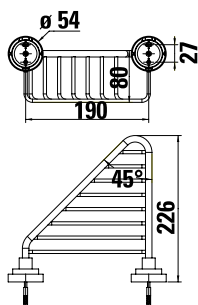

CODE
TA340



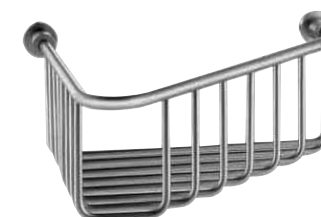

DESCRIPTION
Soap 'n' sponge corner basket

INC VAT £86.53
TVA INC 115.95€





Pictured: QUADRO ACCESSOREIS QU140 30cm towel rail

CODE MO140	DESCRIPTION Towel bar (60cm)	INC VAT £51.31	TVA INC 68.75€	
CODE MO150	DESCRIPTION Towel ring	INC VAT £39.91	TVA INC 53.48€	
CODE MO190	DESCRIPTION Robe hook	INC VAT £19.22	TVA INC 25.76€	
CODE MO230	DESCRIPTION Tumbler holder	INC VAT £32.32	TVA INC 43.31€	
CODE MO260	DESCRIPTION Paper holder	INC VAT £37.11	TVA INC 49.73€	
CODE MO262	DESCRIPTION Paper holder	INC VAT £27.68	TVA INC 37.09€	
CODE MO280	DESCRIPTION Soap dish	INC VAT £32.32	TVA INC 43.31€	
CODE MO310	DESCRIPTION Brush holder	INC VAT £61.46	TVA INC 82.36€	

Accessories Pascale

	CODE PA140	DESCRIPTION Towel bar (60cm)	INC VAT £58.13	TVA INC 77.89€
--	----------------------	--	--------------------------	--------------------------



CODE PA150	DESCRIPTION Towel ring	INC VAT £36.00	TVA INC 48.24€
----------------------	----------------------------------	--------------------------	--------------------------



CODE PA190	DESCRIPTION Robe hook	INC VAT £18.09	TVA INC 24.24€
----------------------	---------------------------------	--------------------------	--------------------------



CODE PA230	DESCRIPTION Tumbler holder	INC VAT £27.55	TVA INC 36.92€
----------------------	--------------------------------------	--------------------------	--------------------------



CODE PA260	DESCRIPTION Paper holder	INC VAT £30.21	TVA INC 40.48€
----------------------	------------------------------------	--------------------------	--------------------------



CODE PA261	DESCRIPTION Paper holder	INC VAT £36.46	TVA INC 48.86€
----------------------	------------------------------------	--------------------------	--------------------------



CODE PA262	DESCRIPTION Euro paper holder	INC VAT £26.17	TVA INC 35.07€
----------------------	---	--------------------------	--------------------------

CODE	DESCRIPTION	INC VAT	TVA INC
PA285	Soap basket	£36.92	49.47€



CODE	DESCRIPTION	INC VAT	TVA INC
PA310	Brush holder	£48.30	64.72€



CODE	DESCRIPTION	INC VAT	TVA INC
PA365	Glass shelf	£52.16	69.89€



CONTENTS

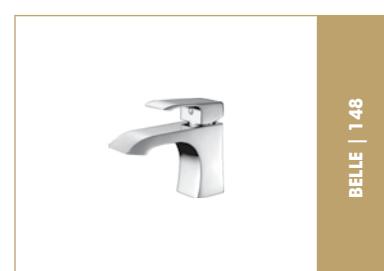
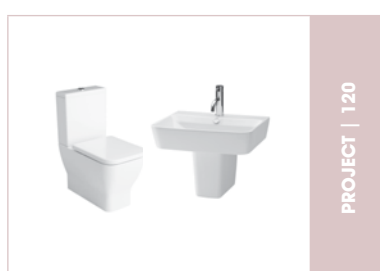
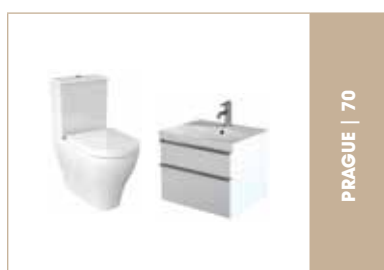
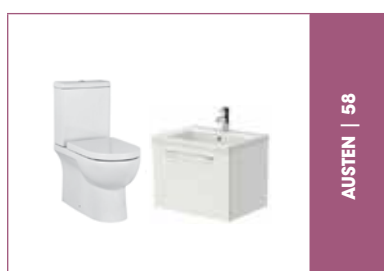
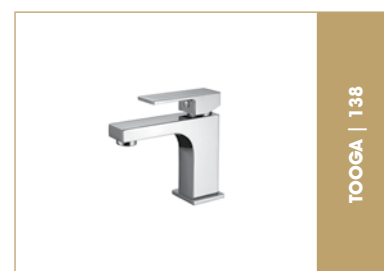
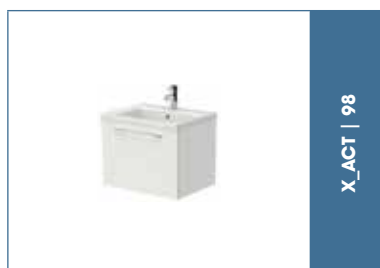
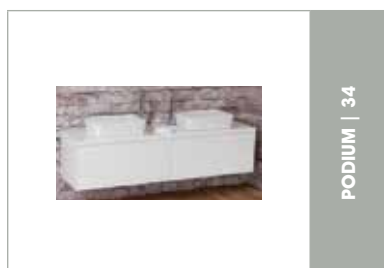
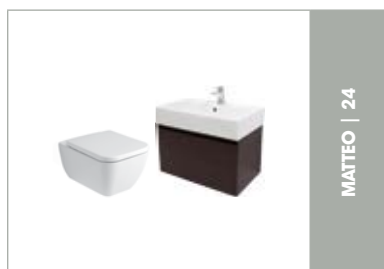



PASCALE | 152



COS | 156

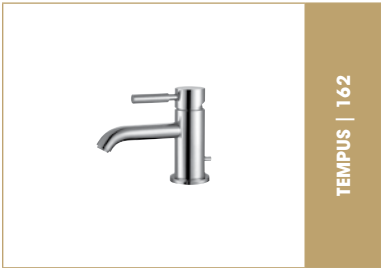

TEMPUS | 162

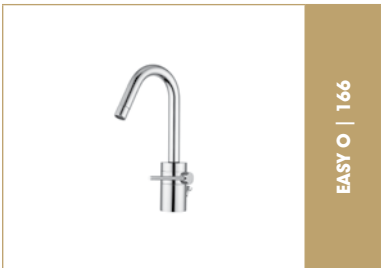

EASY O | 166



INSIDE | 168

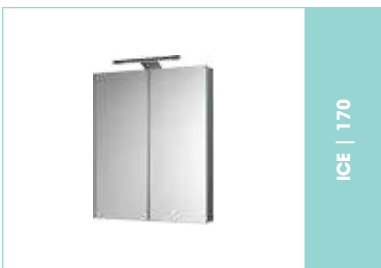

ICE | 170



ELUMINATE | 175



AGUA MAISON | 177

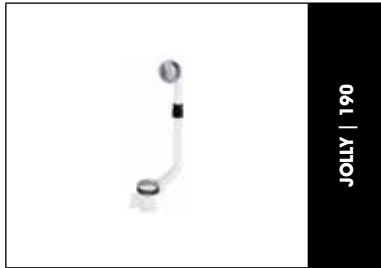

JOLLY | 190



SHOWER ENCLOSURES | 192

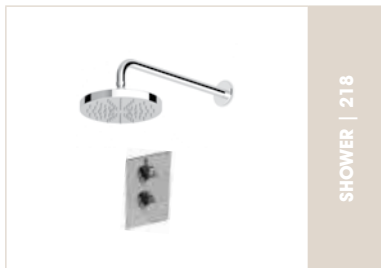

SHOWER | 218

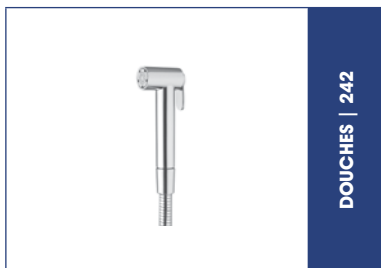

DOUCHES | 242



TEMPUS HEATED TOWEL RAILS | 245

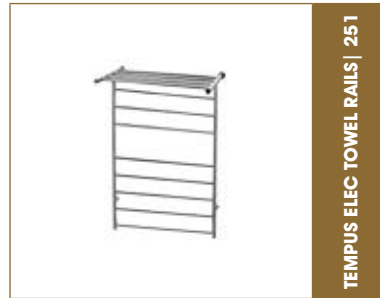

TEMPUS ELEC TOWEL RAILS | 251



BOTTLE TRAPS & BASIN WASTES | 255



ACCESSORIES | 258



TERMS IN BRIEF | 270



CONTACT US | 274

TERMS & CONDITIONS

CONDITIONS OF SALE

1. General

These conditions set out the legal basis upon which we will supply goods. No variation or representation will be valid unless confirmed in writing by a partner.

2. Application of Terms

2.1.1 By placing an order or accepting a quotation the Buyer shall be deemed to be making an offer to buy the goods subject to these conditions.

2.1.2 No order shall be accepted by the Company until written confirmation is issued or (if earlier) the Company delivers the goods.

2.1.3 Any quotation is given on the basis that there is no contract until the Company has accepted an order.

2.2 Quotations unless agreed in writing will be valid for 30 days provided that the Company has not previously withdrawn it.

3. Description

3.1 The quantity and description of goods shall be set out in the Company's quotation or acknowledgment of order.

3.2 All brochures, advertisements and samples are for illustrative purposes only. Dimensions are given as a guide only. Dimensions should not be used for surrounding furniture, fixtures and fittings until the product is on site.

4. Delivery

4.1.1 Delivery shall take place at the Buyer's place of business unless agreed otherwise in writing by the Company.

4.1.2 Dates for delivery are an estimate and time for delivery shall not be made of the essence unless expressly agreed in writing by the Company. If no dates are specified delivery shall be within a reasonable time.

4.2 The Company will not accept liability for any losses caused by delay in delivery.

4.3 If the Buyer fails to take delivery or the Company is unable to deliver the goods because of the fault or failure of the Buyer then:-

- (a) Any risk in the goods shall pass to the Buyer
- (b) The goods shall be deemed to have been delivered; and
- (c) The Company may store the goods at the Buyer's expense.

4.4 The Company reserves the right to deliver the goods by separate instalments.

5. Risk and Ownership

5.1 Ownership in the goods shall not pass to the Buyer until payment in full has been made. The Buyer grants to the Company an irrevocable licence to enter any premises where the goods are or may be stored in order to impact them or to recover them in the event of failure to make payment in full.

5.2 The risk in the goods for nuisance purposes shall pass to the Buyer on delivery.

6. Price

6.1 Unless agreed in writing by the Company the price shall be the price excluding V.A.T set out in the Company's price list on the date of delivery or deemed delivery.

7. Payment

7.1 Payment in cleared funds or cash shall be made on or before delivery (unless credit terms have been agreed in writing by the Company). On occasions the Company will require a Director's guarantee.

7.2 The Company reserves the right to claim interest under the late payment of commercial debts (interest Act 1998).

7.3 In the event of a customer with a credit account going into arrears, if legal action is taken to recover the debt, all amounts owing to the Company shall be deemed as payable, including any current amount.

8. Quality

8.1 The Company will not accept claims for stoppages or damaged goods unless notified within forty-eight hours of delivery. All goods should be physically checked and defects reported to the Company.

8.2 The Company shall not be liable for the cost of installing faulty goods.

8.3 The Company reserves the right to alter the specifications and product range without prior notice.

8.4 The Company will in the event that it supplies faulty goods at its own option repair, replace the goods or refund the price of the goods. If the Company elects to refund the price of the goods the goods shall be returned to the Company at the Company's request and at the Company's expense.

8.5 The Company accepts no liability in relation to goods damaged as a result of failure to follow published instructions or damage caused to the goods after delivery.

8.6 The Company's total liability in contract or tort shall be limited to the contract price. This limitation shall not apply to liability for personal injury or death, fraud or any other matter which it will be illegal for the Company to exclude or attempt to exclude.

9. Returns

Returns will be accepted within three months of delivery provided the goods (exclusions apply - see below) are returned undamaged and with full packaging. It will be subject to a handling charge dependant on condition of goods and packaging and will in any event be a minimum of 20%.

9.1 Returns for the following products will not be accepted under any circumstances:

- All shower enclosures
- All shower trays
- All baths (free-standing & non)
- WC pans with LH/RH cut-outs
- Washbasins with extra tap holes

9.2 Returns may submitted directly to returns@saneux.com providing the following is mentioned:

- Saneux Delivery Reference
- Date of Purchase
- No. of products to return
- Product codes
- Reason for Return
- Image of box in perfect condition

10. Assignment

10.1 The Company shall be entitled to assign the benefit of the contract.

10.2 The Buyer shall not be entitled to assign the benefit of contract.

PRODUCT GUARANTEE

Please refer to each product section for guarantees.

The terms of our guarantee are as follows:-

1. The guarantee only applies to products which:
 - 1.1 are installed in accordance with the fitting instructions supplied, with the products for use in a bathroom with suitable ventilation or a suitable extractor fan; and
 - 1.2 Where the product is a cistern or a tap, it is fitted in accordance with current local and national water regulations; and
 - 1.3 Where the product is a **Saneux** solid surface, it has been stored flat at normal room temperature prior to installation.
2. In the unlikely event that a product supplied by **Saneux** - to which this guarantee applies - fails within the guarantee period from the date of purchase, **Saneux** will supply the customer with a free replacement for the part of the product that has failed, if such failure arises in **Saneux's** reasonable opinion from defects in manufacture or quality of materials and notice in writing giving details of the defects about which there is a complaint given to **Saneux**. The replacement part supplied will be the nearest equivalent to the failed part available in **Saneux's** range at the date the replacement is supplied. Liability is limited to individual products and does not cover consequential loss or damage. The customer will be required to pay the cost of installation of the replacement part. Your statutory rights remain unaffected.
3. The provisions of this guarantee do not affect the customer's statutory rights.
4. The **Saneux** guarantee is limited to the original purchaser and cannot be transferred; this includes the purchasing of ex-display items.
5. To obtain replacement parts in accordance with the provisions of this guarantee please contact the retailer who originally supplied the products.
6. The guarantee only applies to products which are cared for and cleaned in accordance with **Saneux** care and maintenance instructions.

SANITARYWARE

It is the responsibility of the individual installer to ensure the products are fitted correctly and in line with the instructions provided. Failure to comply with the recommended fitting instructions will invalidate the guarantee. When installing **Saneux** wall hung sanitaryware, please ensure the appropriate fixings are used or alternatively a suitable framework.

Sanitaryware dimensions stated should be given a 5% tolerance.

There is a lifetime Guarantee on all sanitaryware products supplied by **Saneux** against manufacturing defects.

BATHROOM FURNITURE

Although designed for bathroom use, bathroom furniture will deteriorate through excessive water spillage, splashing or condensation. Claims cannot be accepted if we regard the furniture to have had improper use. It is advised that all bathrooms are well ventilated using a suitable extraction fan. Furniture must be wiped dry after contact with water.

There is a five year Guarantee on bathroom furniture subject to our furniture care and maintenance guidelines.

CABINET FINISHES AND VENEERED FURNITURE

We cannot guarantee an exact colour match for cabinet finishes due to colour variations incurred as a result from print process. All cabinet finishes reproduced in this brochure should be used as a guide only.

When installing **Saneux** bathroom furniture into a new property or extension we strongly advise the building is dry, well ventilated and adequately heated.

In the production of **Saneux** bathroom furniture, great care is taken in the selection of material. However, due to the manufacturing process, it is not possible, nor do we feel desirable, to strive for total uniformity of shading and grain pattern. Our aim is at all times to operate with controlled parameters which recognize that some variation is both acceptable and aesthetically pleasing. There is a 5 year guarantee on all **Saneux** bathroom furniture against manufacturing defects.

ELECTRICAL PRODUCTS

Please refer to our bathroom regulations for electrical products.

If in any doubt, please consult a qualified electrician for more details.

BATHS

All baths are supplied undrilled.

All baths are manufactured from high quality 5mm cell cast acrylic and are fully reinforced.

There is a five year guarantee on all baths supplied by **Saneux** against manufacturing defects. Any defects must be reported prior to installation commencing.

SHOWER SCREENS

There is a five year guarantee on shower screens supplied by **Saneux** against manufacturing defects.

CONCEALED CISTERNS

There is a two year guarantee on concealed cisterns supplied by **Saneux** against manufacturing defects. It is the responsibility of the individual installer to ensure that these products are fitted correctly and in line with the instructions provided. Failure to comply with the recommended fitting instructions will invalidate the guarantee.

BRASSWARE AND ACCESSORIES

All **Saneux** products, unless otherwise stated carry a 15 year guarantee, which covers all manufacturing defaults.

This guarantee does not cover damage during fitting, misuse or inappropriate cleaning, shower hoses, or cartridges as these are guaranteed for 1 year. Care should be taken in hard water areas to ensure the cartridge is regularly cleaned.

*All products carry a 15 year guarantee (with exception of shower hoses and cartridges which carry a 12 month guarantee).

WORKING PARTS AND COMPONENTS

There is a two year guarantee on all working parts and components supplied with any **Saneux** product, as long as installation has been carried out correctly.

Working parts of all toilet seats are limited to a 12 month warranty period.

SAFETY INSTRUCTIONS FOR CERAMIC SANITARYWARE

To ensure a safe and correct installation, please read the instructions carefully:

- Installation and fixing of the ceramic sanitary ware and accessories to be done by a skilled and trained professional.
- Before installation kindly check the sanitary ware for any damages. If found damaged the product can:
 - Cause injury to the user
 - Result in water leakage
 - Affect the product feature
- Ceramic sanitary ware is fragile. Handling and installation should be done very carefully.
- Avoid jerks and bumps during installation.
- Check the location of mounting and fitting holes before installation. Kindly refer to the instructions specified in the installation manual.
- Installation of sanitary ware should be in horizontal position. Kindly verify with spirit level before use.
- During installation and before connecting to the water supply kindly flush and clean all the outlet and inlet pipes for sand, rubble and trash particles.
- After installation we strongly recommend that the sanitary ware should be securely covered to prevent contamination or damage by any form of building materials such as paint, plaster, tile adhesive, grout or sealants until all building and finishing work is completed.
- After installation kindly check for the grip of the ceramic sanitary ware on the mounted surface to prevent injuries. If the fittings are found loose the product can:
 - Fall down and cause injury to user.
 - Result in water leakage.
- Maximum weight resistance and stability for:
 - Wash Basins – NOT MORE THAN 150 KILOGRAMS
 - Water Closets – NOT MORE THAN 400 KILOGRAMS
 - Bidets – NOT MORE THAN 400 KILOGRAMS

GUIDELINES FOR USE OF CERAMIC SANITARYWARE

To ensure the longevity of the product, kindly follow the instructions carefully:

- Flush the piping with plenty of water prior to installation. It is recommended to use filter taps
- We recommend the use of soft water for all products. If necessary install a water softener
- Do not clean the products with concentrated acids (HCL, HFA, H₂SO₄).
- Do not use sharp edges/iron brush for cleaning.
- After use all products should be maintained by wiping with a soft, damp clean cloth
- Do not expose the ceramic to fire
- Avoid physical and thermal shock during use

We have a policy of continuous improvement and reserve the right to change the specification without notice.

CARE INSTRUCTIONS

Limescale cleaner can be used if necessary, however it should not be used for everyday cleaning and it should not come into contact with metal parts.

Sanitaryware

All ceramic surfaces – washbasin (not unit), WC Pan and seat should be washed with a mild household detergent and warm water. Limescale and other deposits should not be treated with an abrasive remover.

Brassware / Chrome surfaces

Tap, bath waste, shower rail, shower valve and flush plate. Again, these should be washed with a mild household detergent. These can be polished using a non-abrasive buffing cloth. Do not leave the detergent on the products for any period of time.

In order to preserve the original look of your mixers, it is necessary to observe the following instructions for care:

To remove dirt and lime scale stains clean the mixers with water and soap or specific products for chrome-plated surfaces and rinse with clean water and dry with a soft cloth.

Avoid using detergents or acids, rough sponges or steel wool on chrome-plated, coloured, gold-plated or burnished surfaces.

For the plastic or rubber parts do not clean with alcoholic, disinfectant detergents or any solvents, but follow the same procedure as for the mixer body.

Under basin furniture

This should be wiped clean with a soft clean cloth. After use and contact with water, please remove water deposits.

Usage:

Please note; our furniture cannot be used in wet rooms or rooms with minimal ventilation. Our furniture should only be used in clean dry environments at room temperature. It should also be situated away from sources of heat and sunlight. Exposure to these sources will cause the vinyl to crack and peel. Therefore this is not covered in our product guarantee.

Cleaning:

Do not use abrasive cleaners, solvents, polishes, waxes or steam cleaning tools. As a precaution to test the suitability of a cleaning product, apply to an inconspicuous area, minimising the time of exposure and the amount of cleaning agent (diluting as recommended by the supplier) in order to prevent any damage to the surface.

Baths

These should be washed with a mild household detergent and warm water. Limescale and other deposits should not be treated with an abrasive remover.

Further information

In the event of any further information needed or any spare parts, please ring 020 8686 5100 and quote your job reference.



CONTACT US . . .

HOW TO ORDER . . .

UK Account holders/Distributors

Call our UK sales office and speak to one of our helpful sales team on **020 8686 5100**

Fax your order through to **020 8680 3187**

Email your order to **sales@saneux.com**

UK Private customers / Installers / Developers / Contractors

Call our **UK** sales office and one of our helpful sales team will put you in touch with your local saneux stockist. **020 8686 5100**

Get in touch with our planning and estimating team for a free quote.

Email **enquiries@saneux.com** giving your location and we will reply with a list of your nearest saneux stockists

CUSTOMER HELPLINE

Call free! **0800 1973 800** and our customer care team will be more than happy to assist you.

Or email **customerservice@saneux.com** and one of our staff will contact you within 24hours.

NEED IMAGES & TECHNICAL INFO?

Simply email your request to **marketing@saneux.com**

FIND OUT ABOUT OUR SAMPLES SERVICE

Call: **0800 1973 800**

Email: **enquiries@saneux.com**

TO OPEN A SANEUX ACCOUNT . . .

Call our sales office and speak to one of our helpful sales team on **020 8686 5100** or email **enquiries@saneux.com**

THANK YOU

What a show stopper . . .
make a real statement.
Matteo French washstand,
inspired by the French
Rococo, we love this
exuberant style which will
make you . . .

WOW!





saneux

the
space
you love