

accessories

january 2016



12 year guarantee

VADO



contact us

sales 01934 744466 01934 744345 **fax**

email sales@vado-uk.com www.vado-uk.com **web**



shown on front cover:
SHA-184B-C/P
SHA-183-C/P
SHA-182-C/P
MIR-CURVE/DM-LIT



Our stunning collection of accessories ensure the perfect finishing touch to your bathroom.

contents

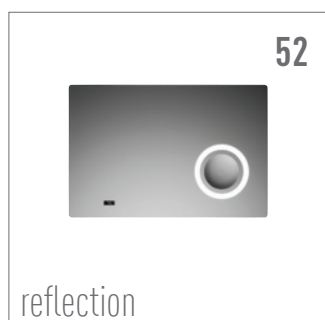
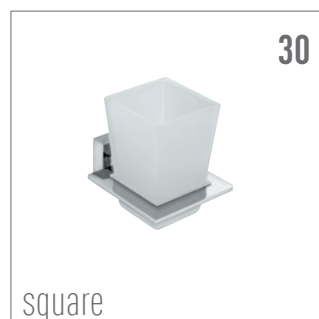
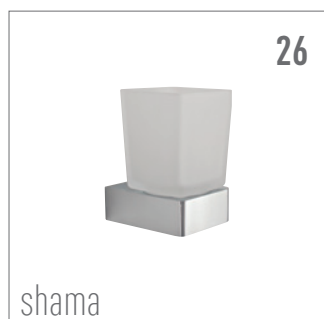

it's a personal experience



VADO is a leading British bathroom brassware manufacturer providing high quality taps, showers, accessories and fittings to customers across the globe.

every product that we offer is created and produced around our four core values

quality

All of our products are passed through stringent quality assurance processes to ensure that they reach the exacting standards that allow us to offer our 12 year guarantee.

design

Our products range from traditional mixers, shower valves and accessories to contemporary designs including waterfall style spouts, handle options in different colours and materials and products that use the latest digital control technology. Our global presence ensures we remain at the cutting edge of international design trends.

service

We pride ourselves on delivering outstanding customer service throughout the entire buying process, from initial query, through to delivery and aftersales care.

innovation

We have a team of people dedicated to developing product ranges that innovate in their form and function. We design products that not only look great but are easy to install, maintain and minimise environmental impact.



Queen's Award

In recognition of our success in global markets, VADO has been awarded The Queen's Award for Enterprise in International Trade.



THE QUEEN'S AWARDS
FOR ENTERPRISE:
INTERNATIONAL TRADE
2012



norcross

VADO is part of the Norcross Group

VADO's strict manufacturing processes ensure our products can be guaranteed for 12 years, giving peace of mind to all customers.

our exacting manufacturing standards are amongst the very best in the industry

at every stage of the production process there is a rigorous quality check



our products are quality checked a minimum of 8 times throughout the production process

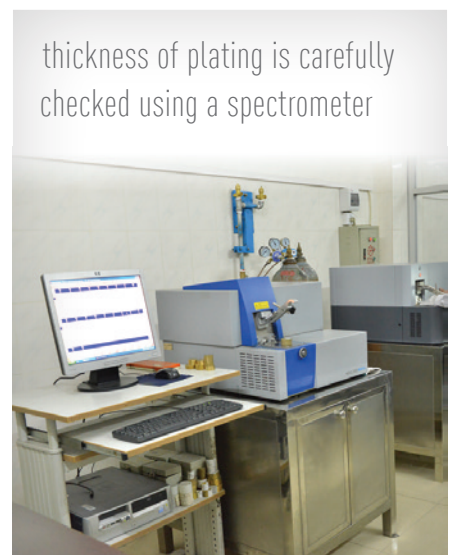

we work closely with the industry's leading standards organisations to reinforce our 12 year guarantee

it's a personal experience



VADO products can be found in some of the most prestigious hotel and residential developments throughout the world.



Millgate Homes, UK



The Shard, UK



London Hilton on Park Lane, UK

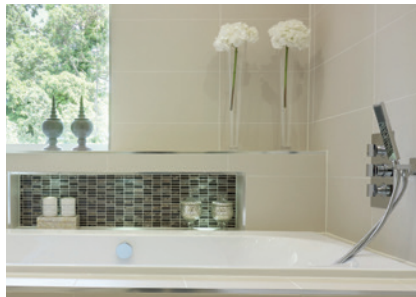

Countryside Properties, UK



Co-operative Group Headquarters, UK



Cornwall Hotel and Spa, UK



Angaga Island Resort, Maldives



The Chedi Hotel, Oman



Four Seasons Hotel, Hong Kong



Freemans Bay Offices, New Zealand



JW Marriott Marquis Hotel, Dubai



The Datai Langkawi Hotel, Malaysia

it's a personal experience



infinity



infinity

shown opposite:
INF-181-C/P
INF-182-C/P
INF-183-C/P



paper holder
INF-180-C/P €67.00



spare paper holder
INF-180S-C/P €62.00

covered paper holder
INF-180A-C/P €89.00



double swivel robe hook
INF-186-C/P €51.00

shower soap holder
INF-182A-C/P €89.00



infinity



frosted glass tumbler and holder
INF-183-C/P €67.00



frosted glass soap dish and holder
INF-182-C/P €67.00

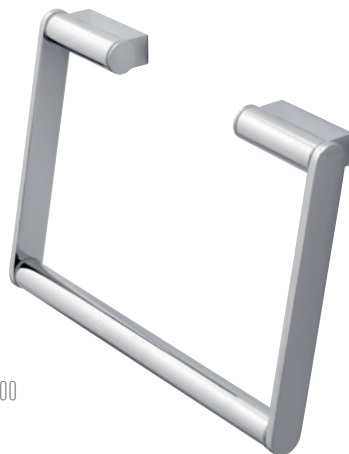

towel ring
INF-181-C/P €99.00

shown opposite:
INF-183-C/P

soap dispenser
ELE-182B-C/P €64.00



toilet brush and polished
stainless steel holder
free standing
INF-188-C/P €78.00



towel rail
450mm (18")
INF-184-45-C/P €119.00

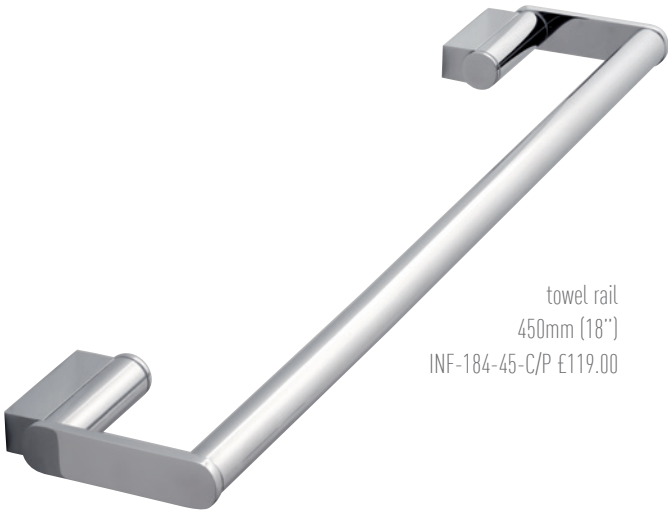

towel rail
600mm (24")
INF-184-60-C/P €129.00

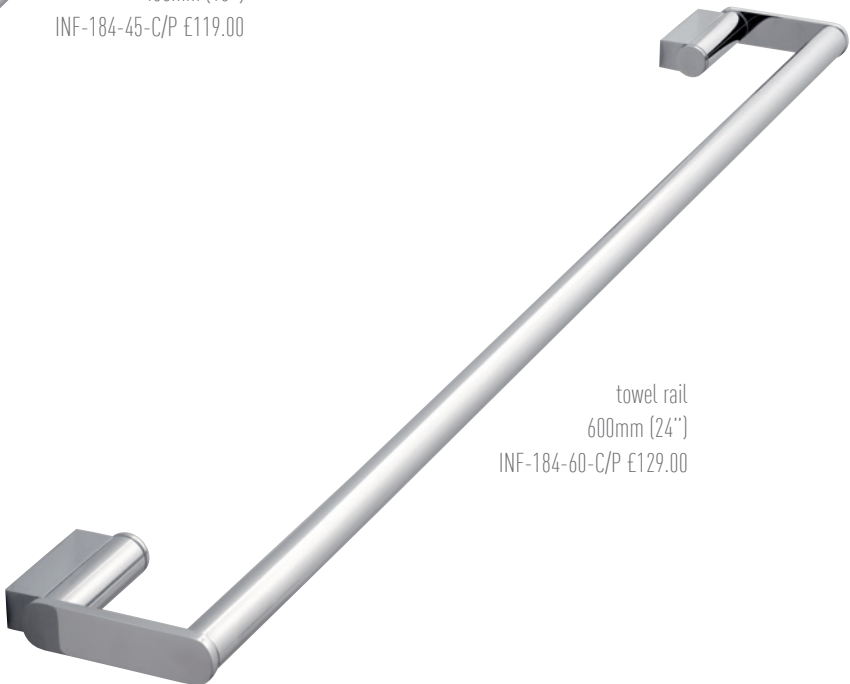

all prices include VAT

soho



shown opposite:
SOH-186-C/P



paper holder
SOH-180-C/P €77.00



frosted glass soap dish and holder
SOH-182-C/P €89.00



towel ring
SOH-181-C/P €72.00



frosted glass soap dispenser
SOH-182A-C/P €124.00



frosted glass tumbler and holder
SOH-183-C/P €89.00

all prices include VAT

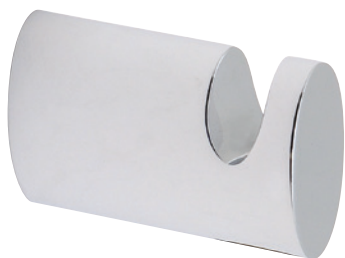

robe hook
SOH-186-C/P €38.00



double robe hook
SOH-186A-C/P €51.00

toilet brush and frosted glass holder
SOH-188-C/P €142.00

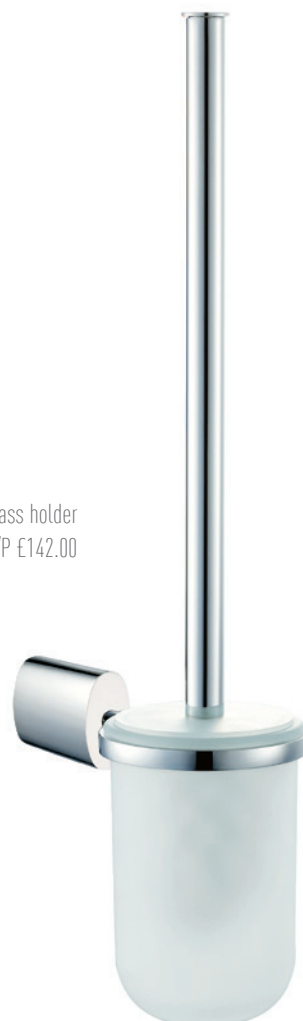

towel rail
600mm (24")
SOH-184-C/P £103.00



metal shelf
490mm (19")
SOH-185-C/P £163.00



towel shelf and towel rail
600mm (24")
SOH-185A-C/P £319.00



eclipse



shown opposite:
ECL-180-C/P

paper holder
ECL-180-C/P €38.00



towel ring
ECL-181-C/P €51.00



robe hook
ECL-186-C/P €33.00





frosted glass tumbler and holder
ECL-183-C/P €47.00



soap dispenser
ELE-182B-C/P €64.00



frosted glass soap dish and holder
ECL-182-C/P €47.00

toilet brush and frosted glass holder
ECL-188-C/P €77.00



towel rail
670mm (26")
ECL-184-C/P €77.00

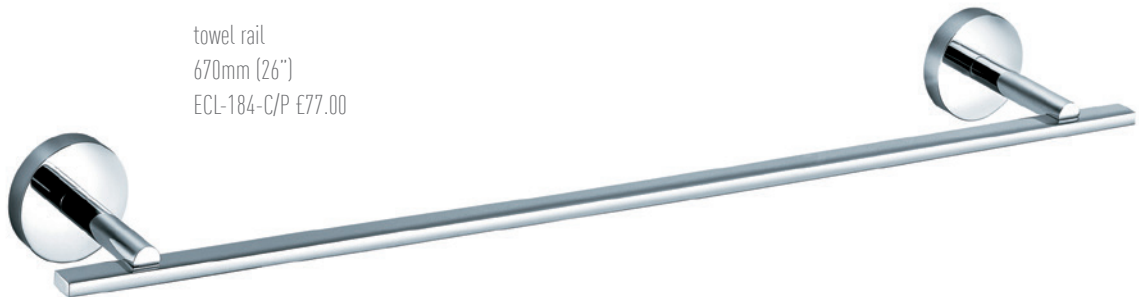

atom



shown opposite:
ATO-184-C/P

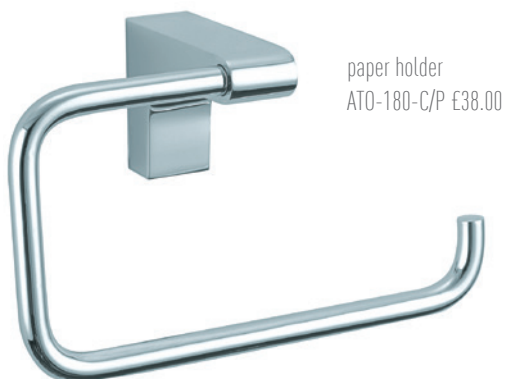

paper holder
ATO-180-C/P €38.00



covered paper holder
ATO-180A-C/P €51.00

robe hook
ATO-186-C/P €33.00



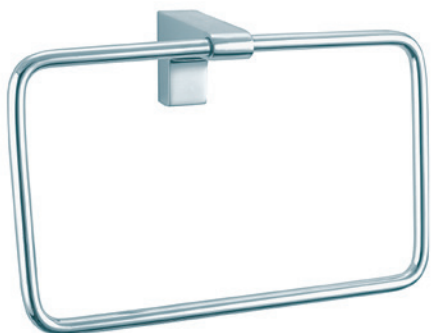

towel ring
ATO-181-C/P €51.00



frosted glass tumbler and holder
ATO-183-C/P €47.00



soap dispenser
ELE-182B-C/P €64.00



frosted glass soap dish and holder
ATO-182-C/P €47.00

toilet brush and frosted glass holder
ATO-188-C/P €77.00



towel rail
615mm (25")
ATO-184-C/P €77.00



level



shown opposite:
LEV-183-C/P

paper holder
LEV-180-C/P €38.00



spare paper holder
LEV-180S-C/P €38.00



towel ring
LEV-181-C/P €55.00

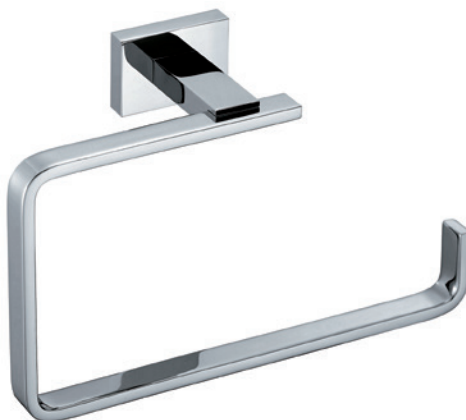

frosted glass tumbler and holder
LEV-183-C/P €47.00

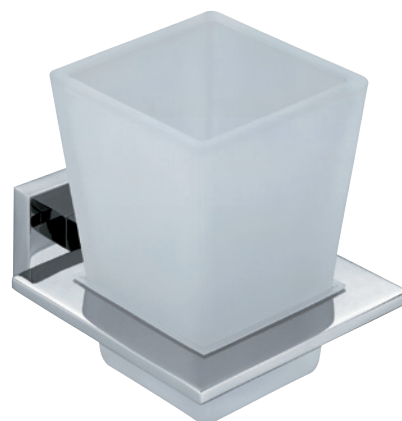

frosted glass soap dish and holder
LEV-182-C/P €47.00



all prices include VAT



robe hook
LEV-186-C/P €33.00



soap dispenser
LEV-182B-C/P €98.00



toilet brush and frosted glass holder
LEV-188-C/P €86.00



frosted glass shelf
550mm (22")
LEV-185-C/P €77.00

towel rail
650mm (26")
LEV-184-C/P €77.00



double towel rail
650mm (26")
LEV-184A-C/P €109.00

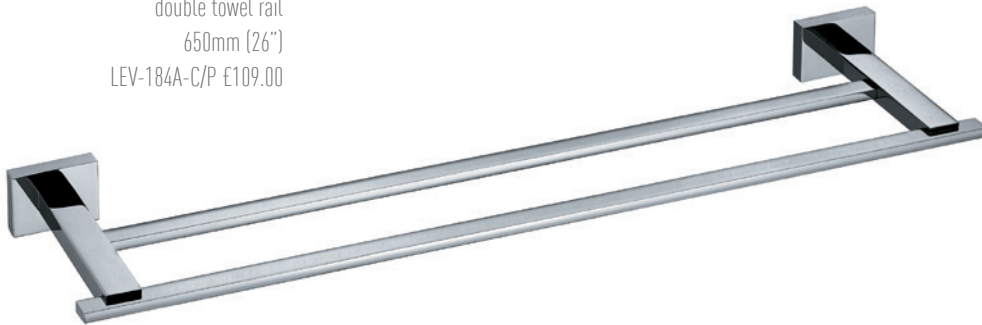

towel shelf with robe hooks
550mm (22")
LEV-185A-C/P €148.00

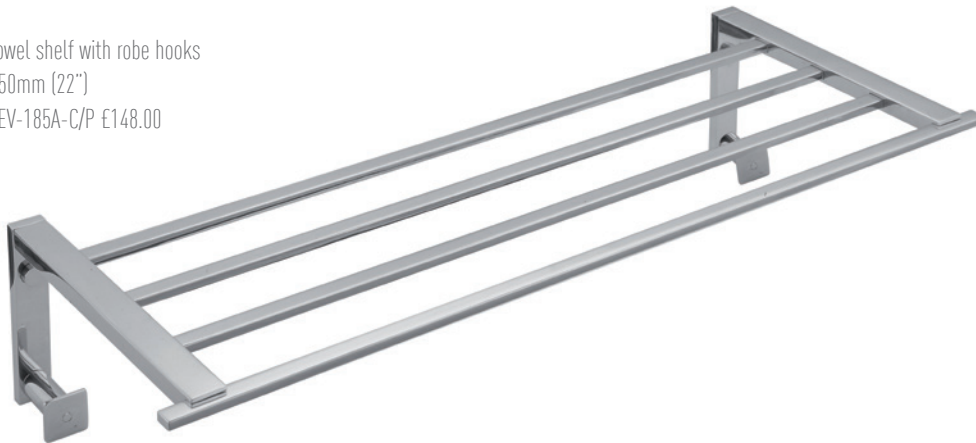

towel shelf with towel rail
550mm (22")
LEV-185B-C/P €208.00



shama



shown opposite:
SHA-184B-C/P

paper holder
SHA-180-C/P €64.00



frosted glass tumbler and holder
SHA-183-C/P €77.00

frosted glass soap dish and holder
SHA-182-C/P €77.00



robe hook
SHA-186-C/P €38.00



soap dispenser
ELE-182B-C/P €64.00



soap dispenser
LEV-182B-C/P €98.00



toilet brush and frosted glass holder
SHA-188-C/P €129.00



towel rail
640mm (25")
SHA-184-C/P €129.00

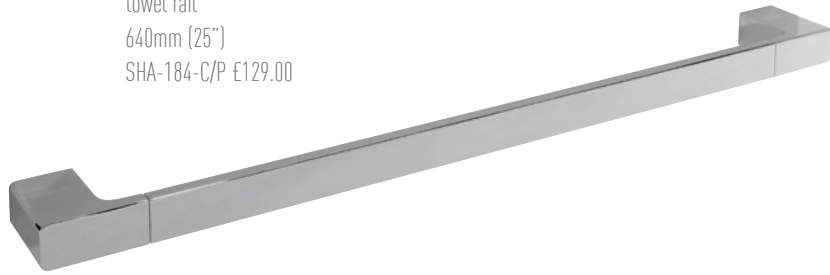

double towel rail
350mm (14")
SHA-184B-C/P €90.00



frosted glass shelf
530mm (21")
SHA-185-C/P €109.00

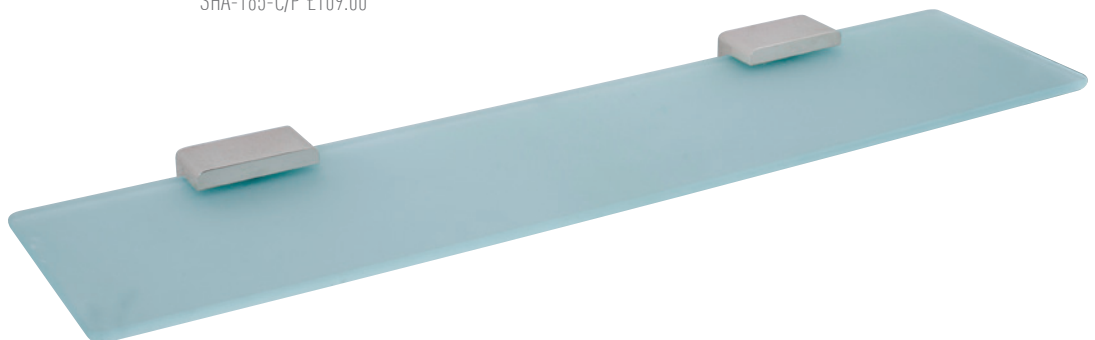

square



shown opposite:
SQU-183-C/P

paper holder
SQU-180-C/P €36.00

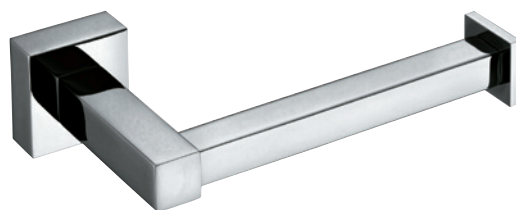

closed paper holder
SQU-180A-C/P €99.00



frosted glass tumbler and holder
SQU-183-C/P €42.00

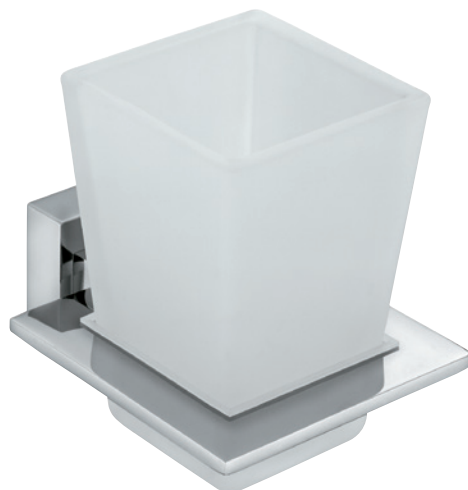

frosted glass soap dish and holder
SQU-182-C/P €42.00



all prices include VAT

square

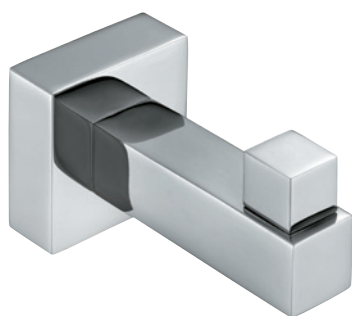

robe hook
SQU-186-C/P €23.00

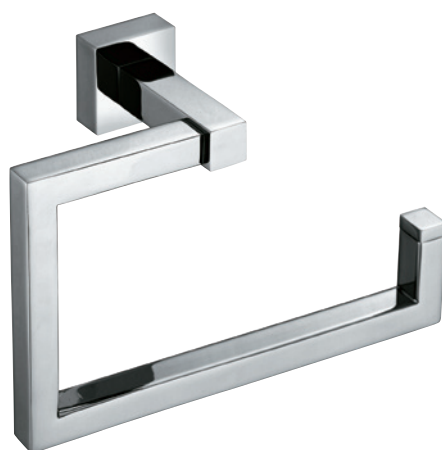

towel ring
SQU-181-C/P €47.00

shown opposite:
SQU-186-C/P

soap dispenser
LEV-182B-C/P €98.00



toilet brush and frosted glass holder
SQU-188-C/P €86.00



towel rail
640mm (25")
SQU-184-C/P €72.00

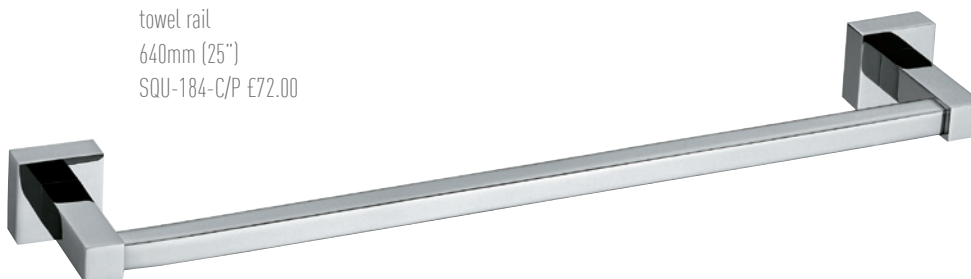

frosted glass shelf
530mm (21")
SQU-185-C/P €86.00

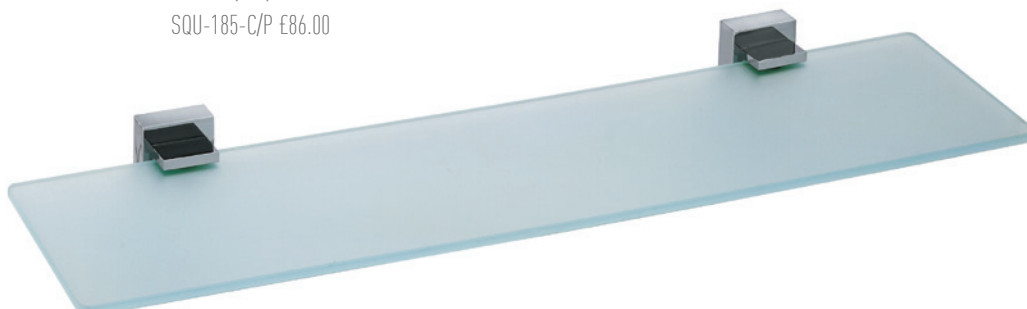

all prices include VAT

life



shown opposite:
LIF-181-C/P

paper holder
LIF-180-C/P €36.00



robe hook
LIF-186-C/P €24.00



towel ring
LIF-181-C/P €63.00



frosted glass tumbler and holder
LIF-183-C/P €46.00



frosted glass soap dish and holder
LIF-182-C/P €46.00



soap dispenser
ELE-182B-C/P €64.00



toilet brush and frosted glass holder
LIF-188-C/P €86.00



frosted glass shelf
530mm (21")
LIF-185-C/P €86.00

towel rail
630mm (25")
LIF-184-C/P £64.00

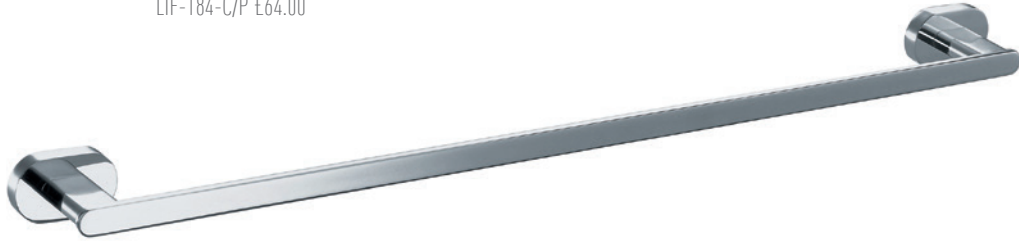

double towel rail
650mm (26")
LIF-184A-C/P £103.00

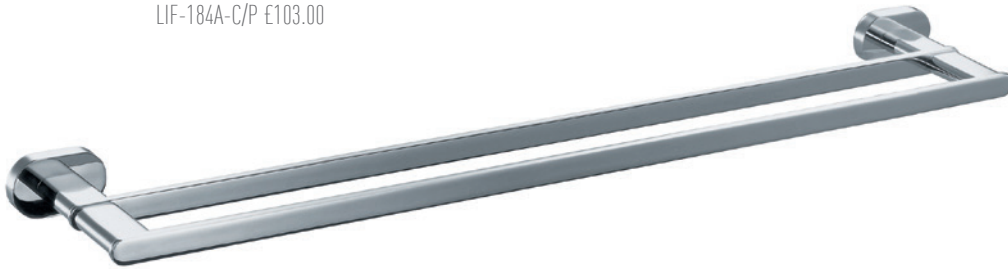

towel shelf
610mm (24")
LIF-185A-C/P £177.00

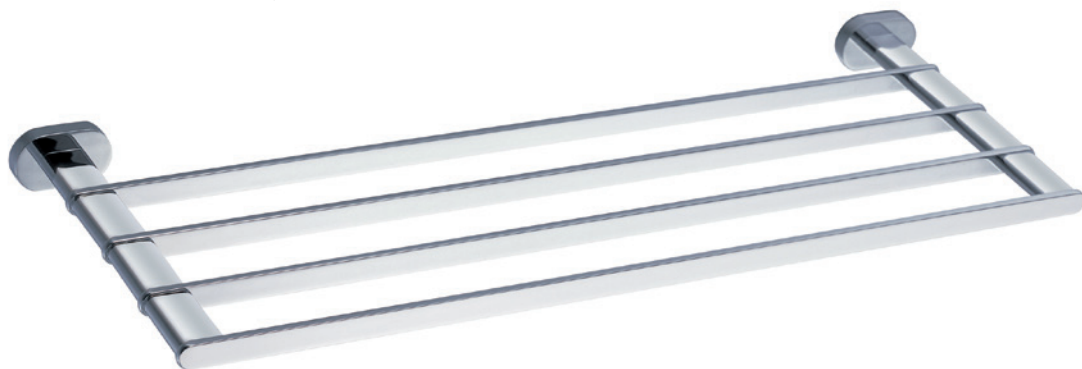



shown opposite:
ELE-182-C/P

paper holder
ELE-180-C/P €51.00



covered paper holder
ELE-180A-C/P €59.00



spare paper holder
ELE-180S-C/P €51.00



new

frosted glass tumbler and holder
ELE-183-C/P €51.00



new

frosted glass soap dish and holder
ELE-182-C/P €51.00



shower soap holder
ELE-182A-C/P €72.00

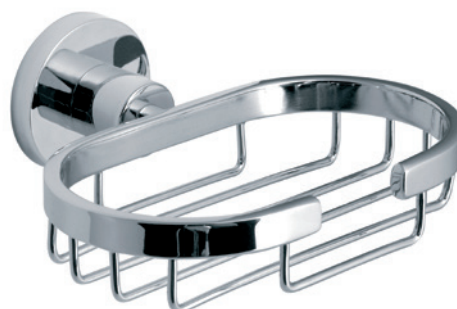

all prices include VAT

elements

soap dispenser
ELE-182B-C/P €64.00



toilet brush and frosted glass holder
ELE-188-C/P €98.00



robe hook
ELE-186-C/P €46.00

towel ring
ELE-181-C/P €51.00



towel rail
695mm (27")
ELE-184-C/P €86.00



double towel rail
695mm (27")
ELE-184A-C/P €98.00



towel shelf
695mm (27")
ELE-185A-C/P €189.00



frosted glass shelf
558mm (22")
ELE-185-C/P €99.00

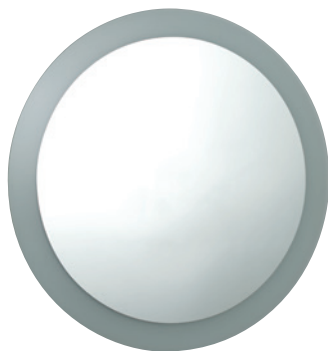
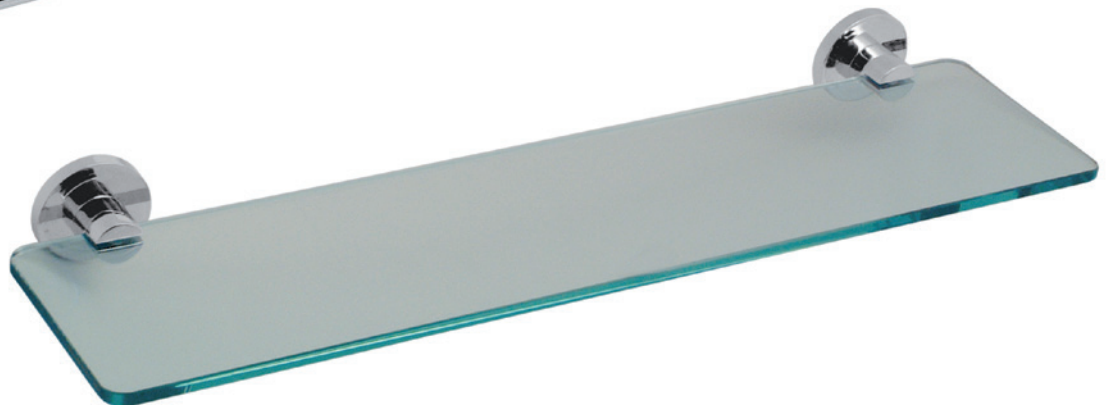

round wall mirror
600mm diameter
ELE-187-RO €108.00

square wall mirror
600 x 600mm
ELE-187-SQ €108.00



all prices include VAT

tournament



tournament

shown opposite:
TOU-185A-C/P



closed paper holder
TOU-180A-C/P €89.00



robe hook
TOU-186-C/P €33.00



towel ring
TOU-181-C/P €42.00

all prices include VAT

tournament

new

ceramic soap dish and holder
TOU-182A-C/P £42.00



new

ceramic tumbler and holder
TOU-183A-C/P £42.00



toilet brush and polished
stainless steel holder
free standing
TOU-188-C/P £114.00



clear glass galley shelf
510mm (20")
TOU-185A-C/P £89.00

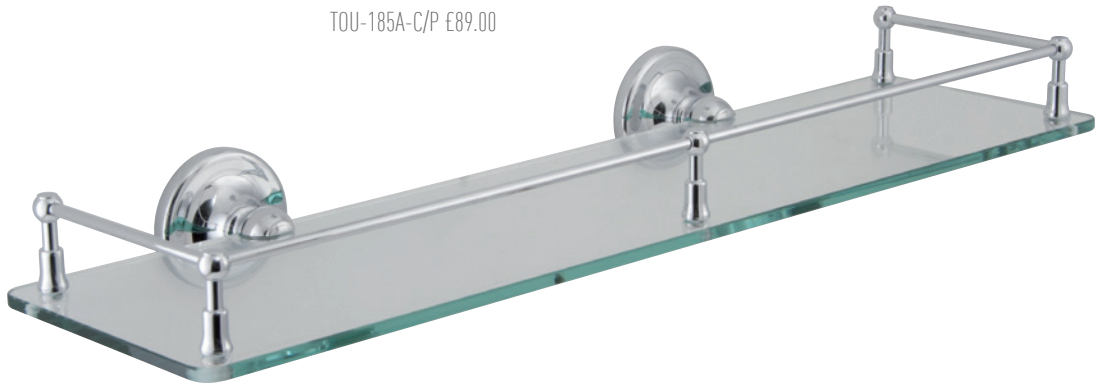

towel rail
560mm (22")
TOU-184-C/P £64.00



baskets



shown opposite:
BAS-2000-C/P

removable corner basket
185 (w) x 185 (d) x 60mm (h)
BAS-2000-C/P €86.00

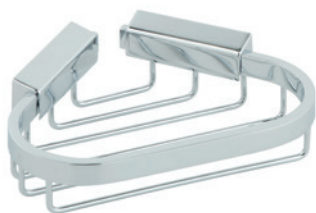
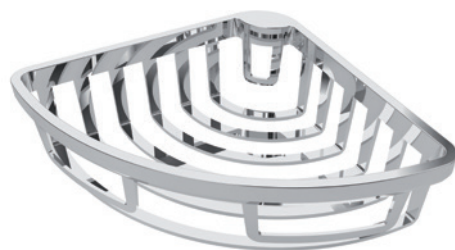

small triangular corner basket
150 (w) x 114 (d) x 36mm (h)
BAS-2015S-C/P €33.00

medium triangular corner basket
220 (w) x 147 (d) x 65mm (h)
BAS-2015M-C/P €42.00

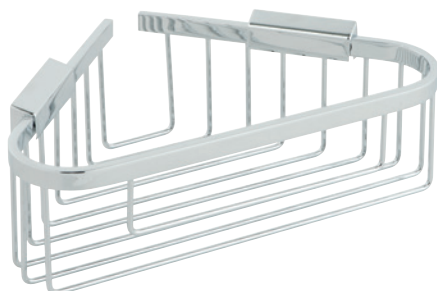
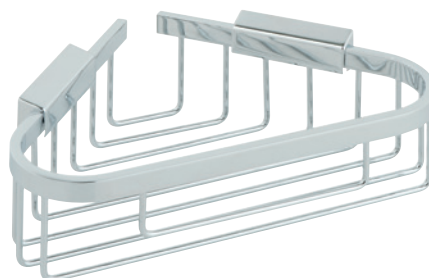

large triangular corner basket
260 (w) x 164 (d) x 85mm (h)
BAS-2015L-C/P €89.00

large triangular corner basket
270 (w) x 194 (d) x 105mm (h)
BAS-2012-C/P €77.00



baskets



corner basket with hook
206 (w) x 206 (d) x 90mm (h)
BAS-2014-C/P €109.00

small rectangular basket
135 (w) x 103 (d) x 37mm (h)
BAS-2001-C/P €33.00

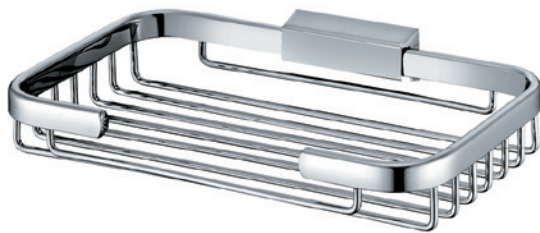
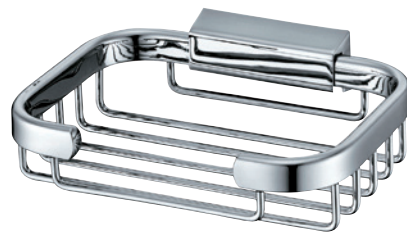

medium rectangular basket
210 (w) x 128 (d) x 37mm (h)
BAS-2002-C/P €38.00

medium rectangular basket
210 (w) x 128 (d) x 65mm (h)
BAS-2016M-C/P €55.00

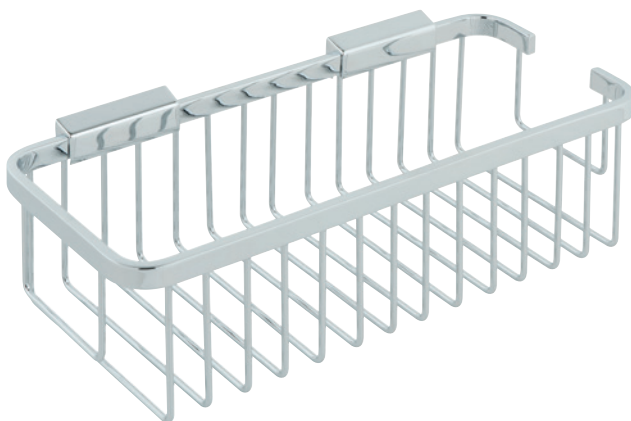
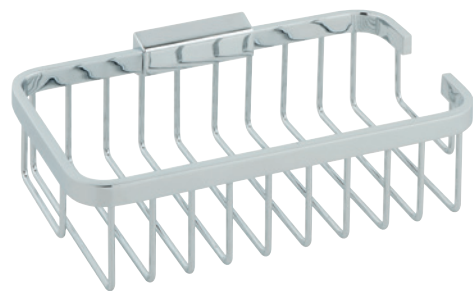

large rectangular basket
300 (w) x 138 (d) x 85mm (h)
BAS-2016L-C/P €66.00

large double triangular corner basket
200 (w) x 160 (d) x 206mm (h)
BAS-2013-C/P €89.00

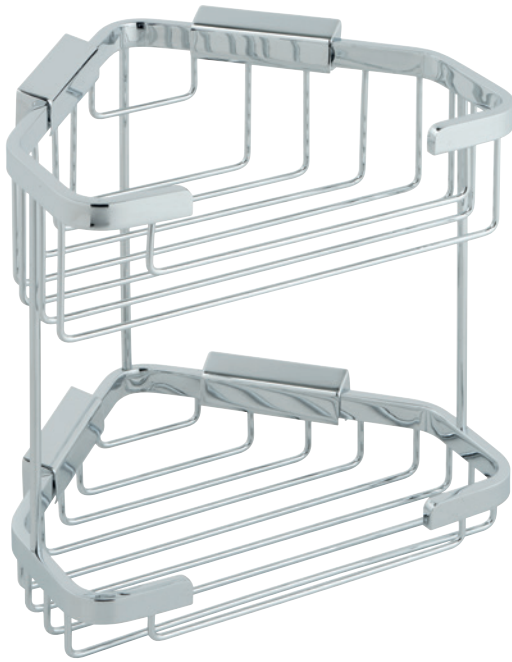

large rectangular double basket
304 (w) x 140 (d) x 484mm (h)
BAS-2003-C/P €163.00

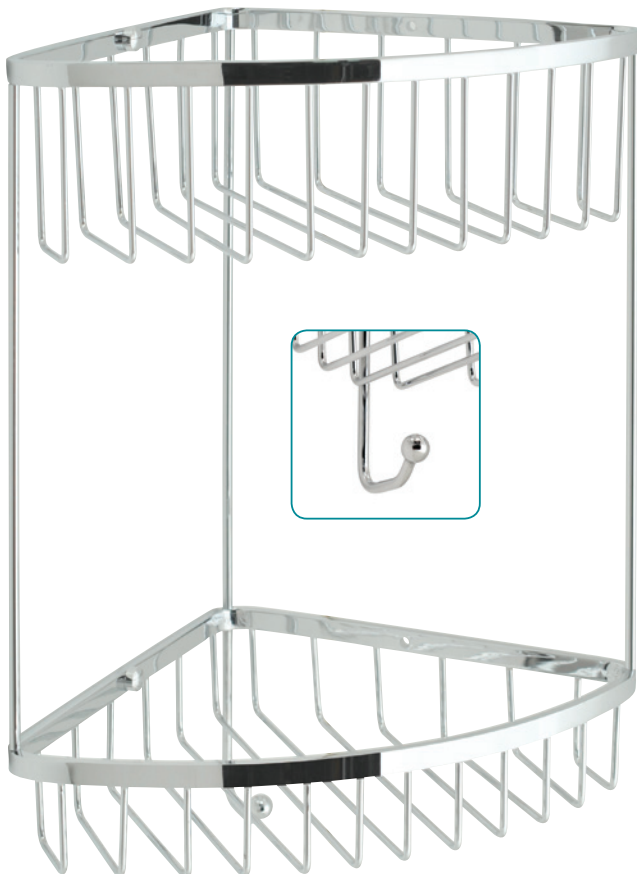

large double triangular corner basket
with integral hook
269 (w) x 196 (d) x 368mm (h)
BAS-2004-C/P €115.00

all prices include VAT

cabinets



cabinets

shown opposite:
CAB-DBL-MIR
TON-109L-C/P

mirrored wall cabinet
with single door
520 (w) x 670 (h) x 130mm (d)
CAB-SGL-MIR €333.00



mirrored wall cabinet
with double doors
780 (w) x 670 (h) x 130mm (d)
CAB-DBL-MIR €405.00



all prices include VAT

reflection



reflection

shown opposite:
MIR-MAG/DM-LIT
GEO-109-220-C/P

illuminate mirror
with sensor operated light
and digital clock
fitted with internal demister
1000 (w) x 700 (h) x 55mm (d)
MIR-ILLUM/DM-LIT £427.00

mist
free



shine mirror
with sensor operated LED lights
and digital clock
fitted with internal demister
800 (w) x 600 (h) x 55mm (d)
MIR-SHINE/DM-LIT £378.00

mist
free

reflection

magnify mirror
with integrated magnifying shaving mirror (3x magnification)
with sensor operated light and digital clock
fitted with internal demister
900 (w) x 600 (h) x 55mm (d)
MIR-MAG/DM-LIT £449.00

mist
free



border mirror
with sensor operated light
fitted with internal demister
900 (w) x 700 (h) x 55mm (d)
MIR-BORDER/DM-LIT £389.00

mist
free

line mirror
with sensor operated light
fitted with internal demister
500 x 700mm
MIR-LINE/DM-LIT £339.00

mist
free



curve mirror
with sensor operated light
fitted with internal demister
1000 x 700mm
MIR-CURVE/DM-LIT £416.00

mist
free

square wall mirror
600 x 600mm
ELE-187-SQ €108.00

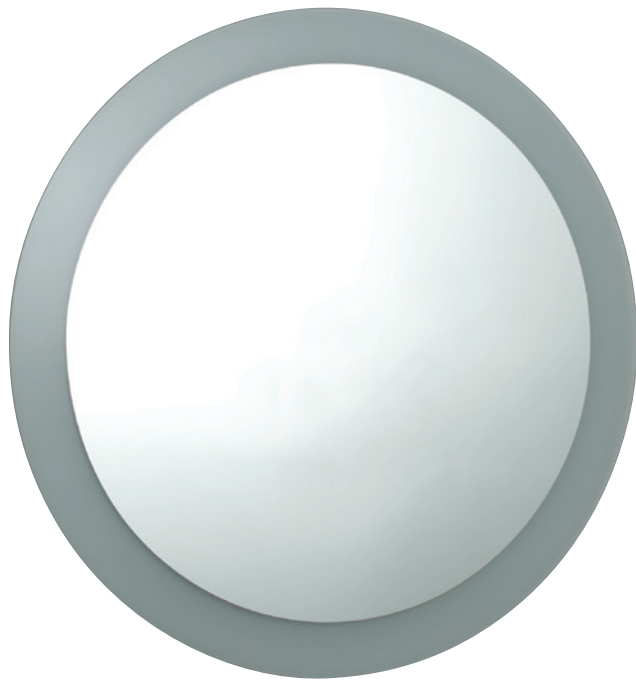

round wall mirror
600mm diameter
ELE-187-RO €108.00

terms and conditions

DEFINITIONS

In these conditions 'the Company' shall mean VADO a division of Norcros Group (Holdings) Limited, 'the purchaser' shall mean the person, firm or company to whom any quotation is addressed or with whom any contract is made and 'the goods' shall mean the goods and/or services agreed to be sold by the Company to the purchaser.

1. QUOTATION AND ACCEPTANCE

- a. All quotations are given and all orders are accepted on these terms which shall apply to the exclusion of and shall override any other terms stipulated or referred to by the purchaser whether in its order or any other document, or in any negotiations or communication or course of dealing established between the Company and the purchaser;
- b. No modification or amendment of these terms or addition thereto shall be effective unless made in writing and signed by a director of the Company.

2. DESCRIPTION OF AND STATEMENTS AS TO GOODS

- a. Save where the goods are stated to be sold as complying with a recognised trade or industry standard, all descriptions, specifications, drawings and particulars of weights and dimensions submitted by the Company or otherwise contained in the Company's catalogues, brochures, price lists, quotations and publicity materials are approximate only and the Company shall not be liable for their accuracy unless they are expressly incorporated into the contract in writing;
- b. These terms represent the entire agreement between the Company and the purchaser relating to the goods and such terms supersede and the purchaser shall not place any reliance upon any statements, recommendations and advice whether oral or in writing given (whether before or after the acceptance by the Company of the purchaser's order) by the Company, its servants or agents as to any matter relating to the goods save where such statement, recommendations or advice is given in writing and signed by a director of the Company in response to a specific written request from the purchaser before or at the time of the Company's acceptance of the order.

3. PRICES

- a. Prices quoted by the Company are those in effect at the date of quotation. Unless otherwise agreed in writing, the Company reserves the right to increase prices when it accepts the purchaser's order so as to reflect one or more of the following:
 - b. any variation that may have occurred in the costs of labour, materials, suppliers overheads and transport;
 - c. any change in duty, tax, surcharge or levy of any kind whatsoever affecting the sale price of the goods;
 - d. any cost to the Company resulting from delay by the purchaser in giving to the Company information sufficient to enable it to supply the goods or provide the services or resulting from any alteration made at the request of the purchaser in the specification of the goods or in the place to which they are to be delivered or shipped; any extra cost to the Company resulting from the goods being carried at the request of the purchaser by mode of transport more expensive than the Company's normal form of transport.

4. PAYMENT

- a. Unless otherwise agreed in writing, the price for the goods will be due and payable on the last business day of the month following delivery;
- b. The Company shall be entitled to charge interest on any part of the price which is not paid in accordance with clause (a) at the rate per annum of 3% above the Base Rate of Lloyds Banking Group from time to time;
- c. Time of payment is of the essence and if the purchaser defaults in punctual payment of the price the Company shall be entitled to terminate the contract and recover the goods at the purchaser's expense without prejudice to any further rights which the Company may have;
- d. Any default in payment of an invoice or an instalment payment on an invoice on the due date shall render the entire balance outstanding on all invoices from the Company to the purchaser immediately payable in full without demand being made notwithstanding any contrary provisions as to terms of payment in any one or all invoices;
- e. If the purchaser fails to give all instructions reasonably required by the Company and all necessary document, licences, consents and authorities for forwarding the goods or is unable to accept delivery of the goods at the time when the goods are due and ready for despatch or delivery or shall otherwise cause or request delay, the purchaser shall pay to the Company all costs and expenses, including storage and insurance charges incurred or arising from such delay during which, at the Company's absolute discretion if its storage facilities permit, the goods will be stored at the purchaser's sole risk. This provision shall be in addition to and not in substitution for any other payment or damages for which the purchaser may be liable in respect of his failure to take delivery at the appropriate date;
- f. The purchaser shall not be entitled to make any deduction from the price of goods which have been delivered to the purchaser in respect of any set off or counterclaim unless both the validity and the amount thereof have been expressly admitted in writing by the Company and such admission is signed by a director of the Company;
- g. In the absence of any specific appropriation by the purchaser, the Company shall have the right to appropriate any payment made by the purchaser towards the satisfaction of any invoice outstanding from time to time as the Company shall in its absolute discretion think fit.

5. DELIVERY

- a. Any time or date stated for delivery is given and intended as an estimate only and the Company shall not be liable for any loss or damage whatsoever resulting from any delay in delivery howsoever arising;
- b. Unless otherwise stated in writing delivery shall be deemed to take place upon the occurrence of the first in time of the following, namely:
 - i. the physical delivery of the goods to the purchaser at the Company's works;
 - ii. the physical delivery of the goods to the purchaser's carrier or agent for the purpose of transmission to the purchaser or his nominee;
 - iii. the physical delivery of the goods to the purchaser's place of business or such other place as he may direct by the Company, its carrier or agent, the purchaser being responsible for unloading;
- c. Signature of the Company's delivery note by any employee, representative or agent of the purchaser shall be conclusive proof of delivery;
- d. Where the contract provides for delivery by the Company, its carrier or agent:
 - i. any claims for non-delivery must be made in writing to the Company within three days of receipt of invoice or advice note whichever is the earlier;
 - ii. any claims in respect of goods damaged in transit or shortages in delivery must be made in writing to the Company within three days of delivery; shortages in delivery shall not give rise to a right to reject the goods delivered;
- e. The Company shall be entitled to make partial deliveries or deliveries by instalments and all the provisions of these terms shall apply to such deliveries;

6. PROPERTY AND RISK

- a. Risk in the goods shall pass to the purchaser at the time at which delivery takes place in accordance with clause 5 above and the purchaser shall be solely responsible for insuring the goods thereafter;
- b. The Company shall retain ownership of and title in the goods delivered until full payment has been made in respect of all such goods. Until such time the goods shall be:
 - i. stored separately from other goods in the possession of the purchaser;
 - ii. marked or otherwise rendered identifiable as being the property of the Company;
 - iii. held by the purchaser as bailee of the Company;
 - iv. held by the purchaser free from any charge, lien or other encumbrance;
- c. Provided the Company has not requested their return and notwithstanding that payment in full has not been made for all of the goods delivered, the purchaser as principal and not as agent for the Company shall be entitled to use the goods or offer for sale and sell them in the ordinary course of his business;
- d. Where the purchaser sells the goods prior to paying for them in full:
 - i. the Company shall be legally and beneficially entitled to the proceeds of sale;
 - ii. the purchaser shall hold the proceeds of sale on trust for the Company and shall not mingle them with other monies and shall not pay them into an overdrawn bank account;

- iii. he shall deposit the proceeds of sale in a separate bank account, the location and number of which he has previously notified to the Company, and he shall not be entitled to use or deal with the proceeds of sale until payment in full for the goods has been made to the Company;
- e. The Company shall have the right at any time by its servants or agents to enter the purchaser's premises where the goods are stored, or are thought the Company to be stored, so as to:
 - i. retake possession of the goods when the Company has requested their return and the purchaser has not immediately complied with the request, such retaking or return to be without prejudice to any other rights the Company may have arising therefrom;
 - ii. inspect the storage of the Company's goods which have not been paid for in full;
 - iii. investigate and ascertain whether all these terms are being complied with;
 - iv.

7. GUARANTEE AND LIABILITY

- a. The Company guarantees all goods which have been manufactured by the Company against any defect of work or materials which can be proved to the Company's satisfaction to have been caused before delivery provided that:
 - i. the goods are used for their normal purpose;
 - ii. full details of any such defect are notified to the Company within thirty days of its first appearance and
 - iii. the goods in which the defect arises are returned at the purchaser's expense to the Company;
- b. The guarantee shall be for a period of twelve years from the date of delivery for all product except pumps which are 3 years for Monsoon and 1 year for Showermate and products with any other finish that is not chrome, such as gold, which are guaranteed for 3 years. The liability of the Company shall be limited at its option either to supply replacement goods, which will be supplied subject to these terms, or refunding of the goods;
- c. The Company gives no guarantee in respect of goods not manufactured by it but shall use all reasonable endeavours to procure for the purchaser or assign to the purchaser the benefit of any guarantee obtained by it from the manufacturer or supplier thereof; however the Company shall not be required to commence litigation against such manufacturer or supplier or to incur any expense in connection with any such claim by the purchaser;
- d. The above guarantee is given in lieu of and to the exclusion of all other warranties, conditions, representations and undertakings express or implied by statute or otherwise in respect of the quality or fitness for purpose of the goods or as to their condition or performance or as to any other matter except where such warranty or condition is implied by statute and by reason of a statutory provision, cannot be excluded;
- e. Save as provided herein and save in any case where death or personal injury has been caused by the Company's negligence or any case where the Company is liable for a defect in the goods pursuant to Part 1 of the Consumer Protection Act 1987 or any statutory replacement thereof, the Company shall be under no liability whatsoever to the purchaser for any loss or damage whether direct, indirect or consequential arising out of any defect in, failure of or unsuitability for any purpose of the goods or any part thereof whether the same be due to any act, omission, breach of contract, negligence or wilful default in design, workmanship or materials or any other cause.

8. INDEMNITY AS TO INDUSTRIAL PROPERTY RIGHTS

- a. The purchaser shall indemnify the Company against all loss, damages, costs and expenses suffered or incurred by the Company or to which the Company may become liable as a result of any work carried out in accordance with the purchaser's specification(s) which involves infringement or alleged infringement of a patent, registered design or other industrial property right;
- b. If the purchaser uses or sells the goods in such a manner as to infringe any such rights the company shall not be responsible for such infringement and the purchaser agrees to indemnify the Company from and against all liability arising therefrom.

9. TERMINATION

The Company shall have the right forthwith to cancel the purchaser's order if any of the following events occur and subject to enforcement of the Company's rights to recover the goods and to receive payment of the price or damages, the contract shall be deemed to have terminated:

- a. the purchaser commits any breach of its obligations to the Company;
- b. any distress or execution is levied upon any property of the purchaser;
- c. the purchaser makes or offers to make any arrangement or composition with creditors or commits any act of bankruptcy or insolvency;
- d. any resolution is passed or petition presented to wind up the purchaser;
- e. a receiver or administrator is appointed or any chargee takes possession of all or any part of the undertaking or assets of the purchaser;
- f. the purchaser stops payment or ceases or threatens to cease to carry on its business or to pay its debts as and when they fall due;
- g. any remittance for payment of the whole or any part of the purchase price of the goods is dishonoured by the purchaser's bankers.

10. ASSIGNMENT

The purchaser shall not assign or transfer or purport to assign or transfer any contract to which these terms apply to any other person without the Company's prior written consent. The Company reserves the right to subcontract the performance of the contract or any part of it.

11. FORCE MAJEURE

If the Company is prevented or delayed (directly or indirectly) from making delivery of the goods or any part thereof or from otherwise performing the contract or any part thereof by reason of war, embargo, riot, strike, lock-out, trade dispute, fire, breakdown of plant or machinery, inclement weather, interruption of transport, Government action, delay in delivery to the Company of any goods or materials, or by any cause whatsoever (whether or not of a like nature to the foregoing) outside its control, it shall be under no liability whatsoever to the purchaser and shall be entitled at its option either to cancel the contract or without any liability to extend the time or times for delivery by a period equivalent to that during which such delivery has been prevented.

12. PROPER LAW

The contract and these terms shall be governed by English law and the purchaser shall submit to the sole jurisdiction of the English Courts.

guarantee

VADO chrome products have a 12 year guarantee

other available catalogues



trade guide

An A5 catalogue ideal for those in the trade, a concise selection of VADO's popular product offering.



consumer catalogue

VADO's tap, showering and accessory collection, the perfect catalogue to give to consumers visiting bathroom showrooms.



showering packages

A collection of showering packages with easy to order codes, taking the hassle out of selecting a shower.



specifications manual

An essential showroom reference tool, which includes technical drawings, pressures and other fundamental technical information for all VADO products.

VADO
wedmore road cheddar somerset england bs27 3eb
tel 01934 744466
fax 01934 744345
www.vado-uk.com
sales@vado-uk.com

due to our policy of continual improvement, VADO reserve the right to change product specification.
the colours indicated are an approximation of the actual finishes on VADO products. e&oe.
©2015 VADO LIT-VADO/ACC-JAN16

