

Always the best climate for

HEATING YOUR HOME

zehnder

always the
best climate

The Zehnder Selection Brochure

Decorative Radiators, Towel Rails
and Extractor Fans

1st July 2016 Issue 1

Zehnder – everything you need to create a comfortable, healthy and energy-efficient indoor climate

Heating, cooling, fresh and clean air: at Zehnder, you will find everything you need to create a comfortable, healthy and energy-efficient indoor climate. Zehnder's wide and clearly structured portfolio can offer the right product for any project, be it private, public or commercial, new build or refurbishment.

Heating

At Zehnder, **heating** doesn't just come in the form of designer radiators. We offer solutions in all shapes and sizes, from radiant ceiling panels to heat pumps with integrated ventilation unit.

- Designer radiators
- Compact energy station with integrated heat pump
- Heating and cooling ceiling systems
- Comfortable indoor ventilation with heat recovery
- Radiant ceiling systems



Zehnder designer radiators, Zehnder Nestsystems

Cooling

Zehnder also offers sophisticated solutions for indoor **cooling**. These range from cooling ceiling systems to comfortable indoor ventilation with a supply of pre-cooled fresh air.

- Heating and cooling ceiling systems
- Compact energy station with heat pump and brine pipe
- Comfortable indoor ventilation with geothermal heat exchanger for fresh air pre-tempering
- Radiant ceiling systems



Zehnder heating and cooling ceiling systems, Zehnder Nestsystems



Most innovative brand
in the category
heating & climate



zehnder

always the
best climate

Fresh Air

Fresh Air – a product range with a long tradition at Zehnder. Zehnder Comfosystems provides products and solutions for comfortable indoor ventilation with heat recovery for houses and apartments, for new builds and for renovation projects.

- Comfortable indoor ventilation
- Compact energy station with integrated ventilation unit



Zehnder Comfosystems

Clean Air

Zehnder Clean Air Solutions provide Clean Air in buildings particularly prone to dust. In residential applications, the comfortable indoor ventilation provided by Zehnder Comfosystems filters external pollutants out of the air.

- Comfortable indoor ventilation with integrated fresh-air filter
- Compact energy unit with integrated fresh-air filter
- Systems for clean air



Zehnder Clean Air Solutions









There's always a good reason for choosing Zehnder.

Starting with more than 100 years of experience as a company which is today part of an international group, to the high quality of materials, production and finishing, and to our service, which means all-round advice and support.

As a multiple award winner, Zehnder designs are often copied. They are synonymous with top-quality, modern products. Many Zehnder inventions have become industry standards of today, such as the multi-column radiator and the towel radiator. With 80 years of experience and competence, you can depend on Zehnder's tailored service and products, delivering bespoke products and colours allowing for individuality and pleasing aesthetics. Our state-of-the-art factories across Europe enable Zehnder to produce high quality products from top quality materials using certified processes which include all-round quality and leakage testing. Zehnder products can provide you with the ideal solutions for a comfortable, healthy and energy-efficient indoor climate.

Symbol Key







- | | |
|--|---|
|  Central heating |  Dual energy radiators |
|  Stainless steel |  m2m radiators |
|  Electric radiators |  Colour |

 All products are CE approved.

 All central heating products certified to EN442.

STOCK: All products listed in bold black type are stocked items.

Product Index	6
Heated towel rails for cloakrooms	7
Heated towel rails for bathrooms	14
Stainless steel heated towel rails and radiators	54
General purpose radiators	72
Electric radiators	108
Extractor fans	114
Accessories, valves, dual energy and electric products	120
Technical specifications	130
How to select the correct radiator	150

Model	 central heating	 stainless steel/brass radiators	 electric radiators	 dual energy radiators	 m2m radiators	 colour availability	CE technical data
Heated towel rails for cloakrooms							
Zehnder Ax Spa	pg 8	-	-	✓	-	✓	pg 135
Zehnder Charleston Bar	pg 10	-	-	-	pg 78	✓	pg 136
Zehnder Metropolitan Spa	pg 12	-	-	✓	-	✓	pg 135
Zehnder Subway	pg 8	pg 8	-	✓	-	✓	pg 133
Zehnder Stellar	-	pg 10	-	✓	-	✓	pg 137
Zehnder Stellar Spa	-	pg 12	-	✓	-	✓	pg 138
Heated towel rails for bathrooms							
Zehnder Ax Spa	pg 38	-	pg 40	✓	-	✓	pg 135
Zehnder Balmoral	pg 52	-	pg 52	✓	-	✓	pg 136
Zehnder Buckingham	pg 52	✓	pg 52	✓	-	-	pg 137
Zehnder Charleston Bar	pg 48	-	-	-	pg 78	✓	pg 136
Zehnder Klaro	pg 20	-	pg 20	✓	-	✓	pg 132
Zehnder Metropolitan Spa	pg 36	-	pg 36	✓	-	✓	pg 135
Zehnder Nobis	pg 50	✓	-	-	-	-	pg 136
Zehnder Osbourne	pg 52	✓	pg 52	✓	-	-	pg 136
Zehnder Quaro Spa NEW	pg 16	pg 56	pg 16	✓	-	✓	pg 132
Zehnder Roda Spa Asym	pg 44	-	pg 46	✓	-	✓	pg 136
Zehnder Roda Spa	pg 42	-	pg 42	✓	-	✓	pg 135
Zehnder Sfera Bow	pg 30	-	pg 30	✓	-	✓	pg 133
Zehnder Subway	pg 24	pg 62	pg 28	✓	-	✓	pg 133
Zehnder Vitalo Bar	pg 18	-	pg 18	-	-	✓	pg 132
Zehnder Yucca Asym	pg 32	-	pg 32	✓	-	✓	pg 134
Zehnder Yucca Sym	pg 34	-	pg 34	✓	-	✓	pg 134
Stainless steel heated towel rails and radiators (Recommended for wet rooms)							
Zehnder Bay	-	pg 70	-	-	-	-	pg 139
Zehnder Cove	-	pg 64	-	✓	-	-	pg 138
Zehnder Keel Asym	-	pg 66	-	✓	-	-	pg 139
Zehnder Keel Sym	-	pg 68	-	✓	-	-	pg 139
Zehnder Quaro Spa NEW	pg 16	pg 56	pg 56	✓	-	-	pg 137
Zehnder Stellar	-	pg 58	-	✓	-	✓	pg 137
Zehnder Stellar Spa	-	pg 60	-	✓	-	✓	pg 138
Zehnder Subway	pg 24	pg 62	✓	✓	-	-	pg 138
General purpose radiators							
Zehnder Ax	pg 92	-	-	-	pg 94	✓	pg 144
Zehnder Charleston	pg 74	-	-	-	pg 78	✓	pg 140
Zehnder Charleston Mirror	pg 80	-	-	-	-	✓	pg 142
Zehnder Charleston Relax	pg 80	-	-	-	-	✓	pg 142
Zehnder Kleo	pg 96	-	-	-	pg 100	✓	pg 146
Zehnder Lyta-S (horizontal)	pg 104	-	-	-	pg 104	-	pg 147
Zehnder Lyta-T (vertical)	pg 106	-	-	-	pg 106	-	pg 147
Zehnder Metropolitan	pg 82	-	-	-	-	✓	pg 142
Zehnder Roda	pg 86	-	pg 112	-	pg 88	✓	pg 143
Zehnder Roda Mirror	pg 90	-	-	-	-	✓	pg 144
Zehnder Stratos	pg 102	-	-	-	-	✓	pg 147
Electric radiators (For electric towel rails, refer to bathroom section)							
Zehnder Alura	-	-	pg 110	-	-	-	-
Zehnder Charleston electric	-	-	pg 112	-	-	✓	-
Zehnder Charleston Plinth electric	-	-	pg 112	-	-	✓	-
Zehnder Fare Tech	-	-	pg 110	-	-	✓	-
Zehnder Roda	-	-	pg 112	-	-	✓	-

Heated towel rails for cloakrooms

Selected for size and style.

A well-chosen, designer radiator will add a touch of luxury and style to any cloakroom. Zehnder has created a range of radiators and towel rails with proportions especially suited to cloakrooms, with a choice of styles and colours to meet all aspirations.



Zehnder Ax Spa



The especially proportioned Ax Spa is ideal for small cloakrooms.



Valves: see page 122



Zehnder Subway



The simple elegance and small projection of the Subway makes it an attractive choice for small spaces.



Valves: see page 122

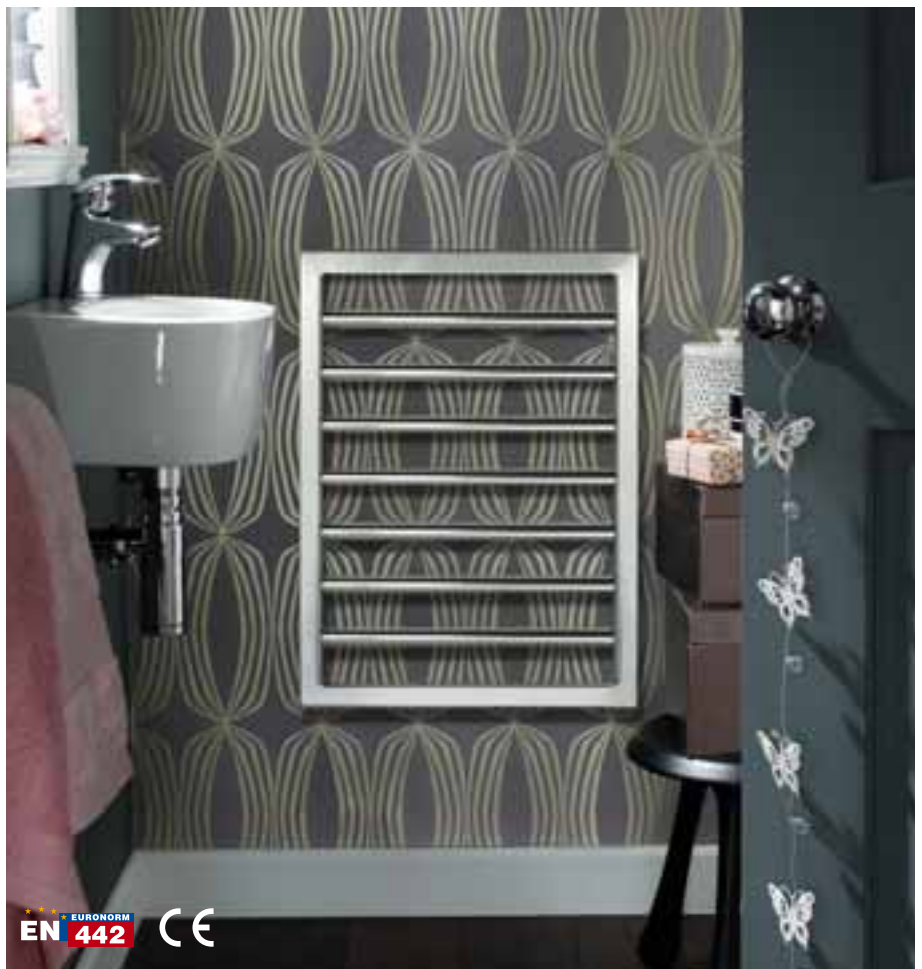

Central Heating Model STOCK listed in black	Height mm	Width mm	Finish	Output $\Delta T=50K$ Watts/btu All outputs certified to EN 442	Electric Immersion Rating Watts	Weight kg	RRP (ex VAT)	RRP (inc 20% VAT)
Zehnder Ax Spa								
ZA-048-040	484	400	white	230/785	n/a	4.5	£162	£194.40
ZA-048-040-0336	484	400	volcanic	230/785	n/a	4.5	£202	£242.40
ZA-048-040-0523	484	400	beige quartz	230/785	n/a	4.5	£202	£242.40
ZA-048-040-0529	484	400	brown quartz	230/785	n/a	4.5	£202	£242.40

Projection: 97-112mm

Colour finish: Standard colours from the Zehnder colour chart including matt white finish: white RAL 9016 + 25%. Colour finish and non-stock products delivery: 20-30 working days.

Suggested valves (to suit pipework from the wall)

Model		RRP (ex VAT)	RRP (inc 20% VAT)
VAL-SET-2-CR	Contemporary double angled radiator valve set chrome plated	£54	£64.80
VAL-SET-11-CR	Thermostatic double angled valve set chrome plated	£165	£198.00

See page 38 for additional Ax Spa sizes, technical information and options, and pages 122 -127 for valve options

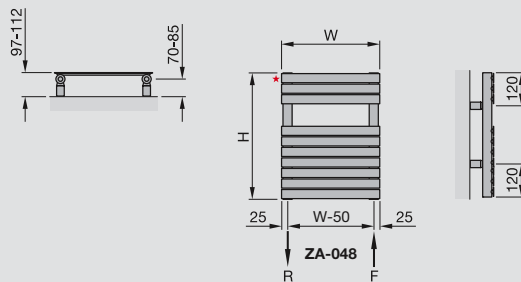

*1/8" air vent
Width excludes air vent
F = flow
R = return
H = height
W = width
Tube: Horizontal 38x10.5
Tube: Vertical \varnothing 38mm
All dimensions in mm

For full compliant technical specifications, refer to page 135

Central Heating Model STOCK listed in black	Height mm	Width mm	Finish	Output $\Delta T=50K$ Watts/btu All outputs certified to EN 442	Electric Immersion Rating Watts	Weight kg	RRP (ex VAT)	RRP (inc 20% VAT)
Zehnder Subway								
SUB-060-045	613	450	white	310/1058	200	5.2	£160	£192.00
SUB-060-045-0335	613	450	titane	310/1058	200	5.2	£200	£240.00
SUB-060-045-0336	613	450	volcanic	310/1058	200	5.2	£200	£240.00
SUB-060-045-0523	613	450	beige quartz	310/1058	200	5.2	£200	£240.00
SUB-060-045-0529	613	450	brown quartz	310/1058	200	5.2	£200	£240.00
SUBC-060-045	613	450	chrome	205/699	100	5.2	£347	£416.40
SUBI-060-045	613	450	stainless steel	221/754	150	5.1	£392	£470.40

Projection: 70-80mm or 90-100mm, dependant on brackets selected. See page 27 for details

Colour finish: Standard colours from the Zehnder colour chart including matt white finish: white RAL 9016 + 25%. Colour finish and non-stock products delivery: 20-30 working days.

Suggested valves (to suit pipework from the wall)

Model		RRP (ex VAT)	RRP (inc 20% VAT)
VAL-SET-6-CR	Square head double angled valve set chrome plated	£192	£230.40

See pages 25 and 63 for additional Subway sizes, technical information and options, and pages 122 -127 for valve options

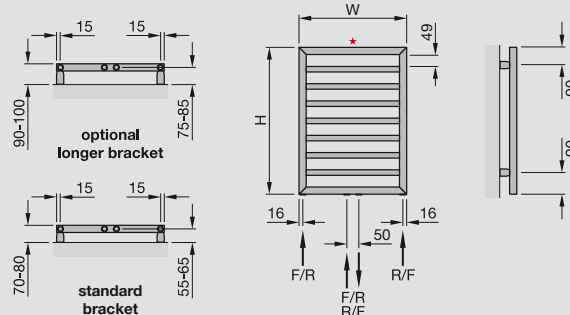

*1/2" air vent
Height excludes air vent
F = flow
R = return
H = height
W = width
Tube: Horizontal \varnothing 23mm
Tube: Vertical 30x30mm
All dimensions in mm

For full compliant technical specifications, refer to page 133
To make an approximate conversion from T=50K to T=60K multiply outputs by 1.2

SUB-060
SUBI-060
SUBC-060

Zehnder Charleston Bar



At only 306mm wide, this especially created, stocked size of the Charleston is idea for narrow spaces. The chrome towel bar is included.



Valves: see page 122



Zehnder Stellar



The stainless steel Stellar with its neat proportions and narrow projection is a new favourite for cloakrooms.



Valves: see page 122



Central Heating Model STOCK listed in black	Height mm	Width mm	Finish	Output $\Delta T=50K$ Watts/btu All outputs certified to EN 442	Electric Immersion Rating Watts	Weight kg	RRP (ex VAT)	RRP (inc 20% VAT)
Zehnder Charleston Bar								
2075-6	742	306	white	330/1128	n/a	7.2	£234	£280.80
2075-6-0336	742	306	volcanic	330/1128	n/a	7.2	£261	£313.20

Chrome towel bar included. Projection including towel bar: 134mm

Colour finish: Standard colours from the Zehnder colour chart including matt white finish: white RAL 9016 + 25%. Colour finish and non-stock products delivery: 20-30 working days.

Accessories			
Model		RRP (ex VAT)	RRP (inc 20% VAT)
601020	Lambs wool brush	£49	£58.80
966018	Additional 368mm Towel Bar	£125	£150.00

The additional chrome bar can be cut down to fit if required

Suggested valves (to suit pipework from the wall)			
Model		RRP (ex VAT)	RRP (inc 20% VAT)
VAL-SET-2-CR	Contemporary double angled radiator valve set chrome plated	£54	£64.80
VAL-SET-10-CR	Thermostatic double angled valve set chrome plated	£165	£198.00
VAL-SET-11-CR	Thermostatic double angled valve set chrome plated	£165	£198.00

See pages 74 to 79 for additional Charleston sizes, technical information and options, and pages 122 -127 for valve options

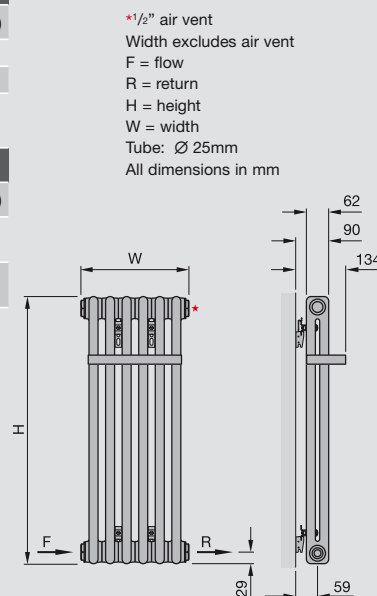

For full compliant technical specifications, refer to page 136

Central Heating Model STOCK listed in black	Height mm	Width mm	Finish	Output $\Delta T=50K$ Watts/btu All outputs certified to EN 442	Electric Immersion Rating Watts	Weight kg	RRP (ex VAT)	RRP (inc 20% VAT)
Zehnder Stellar Stainless Steel								
STNI-080-030	788	300	s/steel polished	159/541	100	3.4	£223	£267.60
STNI-060-045	572	450	s/steel polished	159/541	100	3.0	£225	£270.00

Projection: 90-100mm

Colour finish: Standard colours from the Zehnder colour chart including matt white finish: white RAL 9016 + 25%. Colour finish and non-stock products delivery: 20-30 working days.

Suggested valves (to suit pipework from the wall)			
Model		RRP (ex VAT)	RRP (inc 20% VAT)
VAL-SET-6-CR	Square head double angled valve set chrome plated	£192	£230.40

See pages 59 and 60 for additional Stellar sizes, technical information and options, and pages 122 -127 for valve options

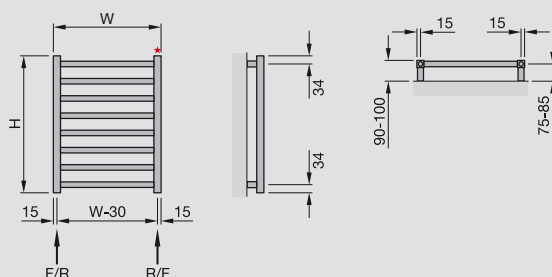

*1/2" air vent
Height excludes air vent
F = flow
R = return
H = height
W = width
Tube: Horizontal \varnothing 30x15mm
Tube: Vertical \varnothing 30x30mm
All dimensions in mm

For full compliant technical specifications, refer to page 137
To make an approximate conversion from T=50K to T=60K multiply outputs by 1.2

Zehnder Metropolitan Spa



The Zehnder Metropolitan is a modern, stylish and elegant interpretation of the traditional towel radiator now in cloakroom compatible sizes.



Valves: see page 122



Zehnder Stellar Spa



The Zehnder Stellar Spa in stainless steel construction is a simple yet stylish towel radiator at affordable prices.



Valves: see page 122



Central Heating Model STOCK listed in black	Height mm	Width mm	Finish	Output $\Delta T=50K$ Watts/btu All outputs certified to EN 442	Electric Immersion Rating Watts	Weight kg	RRP (ex VAT)	RRP (inc 20% VAT)
---	-----------	----------	--------	--	---------------------------------	-----------	--------------	-------------------

Zehnder Metropolitan Spa								
MET-080-040	805	400	white	327/1115	300	6.5	£311	£373.20

Colour finish: Standard colours from the Zehnder colour chart including matt white finish: white RAL 9016 + 25%. Colour finish and non-stock products delivery: 20-30 working days.

Suggested valves (to suit pipework from the wall)			
Model		RRP (ex VAT)	RRP (inc 20% VAT)
VAL-SET-2-CR	Contemporary double angled radiator valve set chrome plated	£54	£64.80
VAL-SET-10-CR VAL-SET-11-CR	Thermostatic double angled valve set chrome plated	£165	£198.00

See pages 36-37 and 82-85 for additional Metropolitan sizes, technical information and options, and pages 122 -127 for valve options

*1/2" air vent
Width excludes air vent
F = flow
R = return
H = height
W = width
Tube: \varnothing 25mm
All dimensions in mm

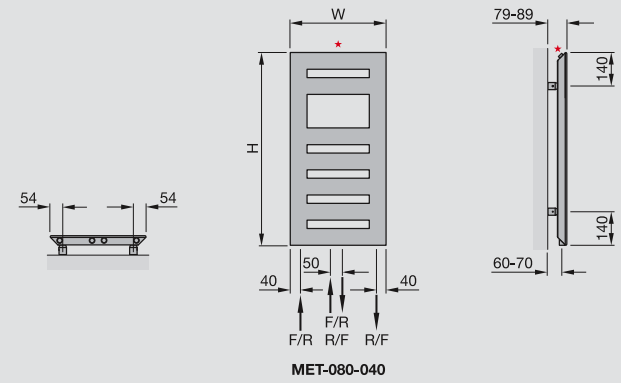

For full compliant technical specifications, refer to page 135

Central Heating Model STOCK listed in black	Height mm	Width mm	Finish	Output $\Delta T=50K$ Watts/btu All outputs certified to EN 442	Electric Immersion Rating Watts	Weight kg	RRP (ex VAT)	RRP (inc 20% VAT)
---	-----------	----------	--------	--	---------------------------------	-----------	--------------	-------------------

Zehnder Stellar Spa Stainless Steel								
STGI-060-045	572	450	stainless steel	161/549	100	3.0	£203	£243.60
STGI-080-030	788	300	stainless steel	171/583	100	3.3	£202	£242.40

Suggested valves (to suit pipework from the wall)			
Model		RRP (ex VAT)	RRP (inc 20% VAT)
VAL-SET-6-CR	Square head double angled valve set chrome plated	£192	£230.40

See pages 59 and 60 for additional Stellar sizes, technical information and options, and pages 122 -127 for valve options

*1/2" air vent
Height excludes air vent
F = flow
R = return
H = height
W = width
Tube: Horizontal \varnothing 23mm
Tube: Vertical \varnothing 30mm
All dimensions in mm

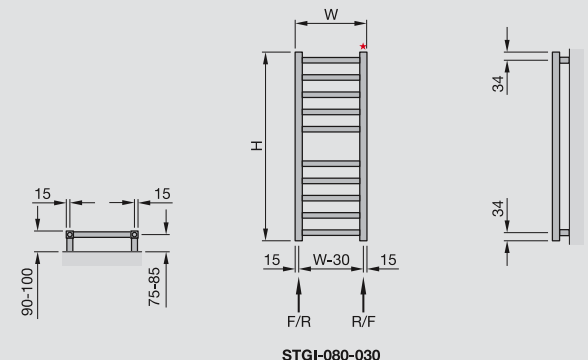

For full compliant technical specifications, refer to page 138
To make an approximate conversion from T=50K to T=60K multiply outputs by 1.2

Heated towel rails for bathrooms

Heat at its most attractive.

Zehnder's designer radiators not only make homes warmer, they add an unmistakable look and feel. This is hardly surprising, as they are the work of well-known designers. Performance is of course also a key factor. Thanks to Zehnder's ability to combine style and functionality, you can be absolutely sure that our radiators will be up to the mark in your bathrooms, kitchens and cloakrooms, as well as in those areas of the home dedicated to exercise or hobbies.





Zehnder Quaro Spa



The new Zehnder Quaro Spa has an elegant square profile frame and horizontal heating pipes. Beautifully designed with clarity and simplicity, even the right-angled wall brackets look cool! Generously spaced tubes give plenty of room for warming fluffy towels. Available in chrome and 3 stocked colours, as well as over 50 colours to order. Also available in electric and stainless steel versions.



Flame Red



Volcanic

Central Heating Model STOCK listed in black	Height mm	Width mm	Finish	Output $\Delta T=50K$ Watts/Btu All outputs certified to EN 442	Weight kg	RRP (ex VAT)	RRP (inc 20% VAT)
Zehnder Quaro Spa NEW							
QS-075-045	803	450	white	332 / 1133	7.5	£170	£204.00
QS-120-045	1251	450	white	493 / 1682	10.3	£185	£222.00
QS-120-055	1251	550	white	580 / 1979	12.0	£209	£250.80
QS-150-045	1507	450	white	588 / 2006	11.9	£222	£266.40
QS-150-055	1507	550	white	694 / 2368	14.0	£245	£294.00
QS-180-055	1827	550	white	851 / 2904	16.9	£278	£333.60
QS-075-045-0346	803	450	anthracite	332 / 1133	7.5	£213	£255.60
QS-120-045-0346	1251	450	anthracite	493 / 1682	10.3	£231	£277.20
QS-120-055-0346	1251	550	anthracite	580 / 1979	12.0	£261	£313.20
QS-150-045-0346	1507	450	anthracite	588 / 2006	11.9	£278	£333.60
QS-150-055-0346	1507	550	anthracite	694 / 2368	14.0	£306	£367.20
QS-180-055-0346	1827	550	anthracite	851 / 2904	16.9	£348	£417.60
QS-075-045-0523	803	450	beige quartz	332 / 1133	7.5	£213	£255.60
QS-120-045-0523	1251	450	beige quartz	493 / 1682	10.3	£231	£277.20
QS-120-055-0523	1251	550	beige quartz	580 / 1979	12.0	£261	£313.20
QS-150-045-0523	1507	450	beige quartz	588 / 2006	11.9	£278	£333.60
QS-150-055-0523	1507	550	beige quartz	694 / 2368	14.0	£306	£367.20
QS-180-055-0523	1827	550	beige quartz	851 / 2904	16.9	£348	£417.60
QSC-075-045	803	450	chrome	206 / 703	7.1	£379	£454.80
QSC-120-045	1251	450	chrome	313 / 1068	9.8	£485	£582.00
QSC-120-055	1251	550	chrome	376 / 1283	11.6	£538	£645.60
QSC-150-045	1507	450	chrome	371 / 1266	11.3	£595	£714.00
QSC-150-055	1507	550	chrome	443 / 1512	13.4	£640	£768.00
QSC-180-055	1827	550	chrome	544 / 1856	16.1	£725	£870.00

Electric Heating Model	Height mm	Width mm	Finish	Electric Immersion Rating Watts with Safir Class II, IPX4 Zone 1 bath, Zone 2 shower	Weight kg	RRP (ex VAT)	RRP (inc 20% VAT)
Zehnder Quaro Spa Electric NEW							
QSE-075-045/IF	833	450	white	300	11.3	£420	£504.00
QSE-120-045/IF	1281	450	white	300	15.4	£435	£522.00
QSE-120-055/IF	1281	550	white	500	17.8	£459	£550.80
QSE-150-045/IF	1537	450	white	500	17.9	£472	£566.40
QSE-150-055/IF	1537	550	white	600	20.8	£495	£594.00
QSE-180-055/IF	1857	550	white	750	25.1	£528	£633.60
QSEC-120-045/IF	1281	450	chrome	300	14.9	£735	£882.00
QSEC-120-055/IF	1281	550	chrome	300	17.4	£788	£945.60
QSEC-150-045/IF	1537	450	chrome	300	17.3	£845	£1,014.00
QSEC-150-055/IF	1537	550	chrome	300	20.2	£890	£1,068.00
QSEC-180-055/IF	1857	550	chrome	500	24.3	£975	£1,170.00

Colour finish: Standard colours from the Zehnder colour chart including matt white finish: white RAL 9016 + 25%. Colour finish and non-stock products delivery: 20-30 working days.

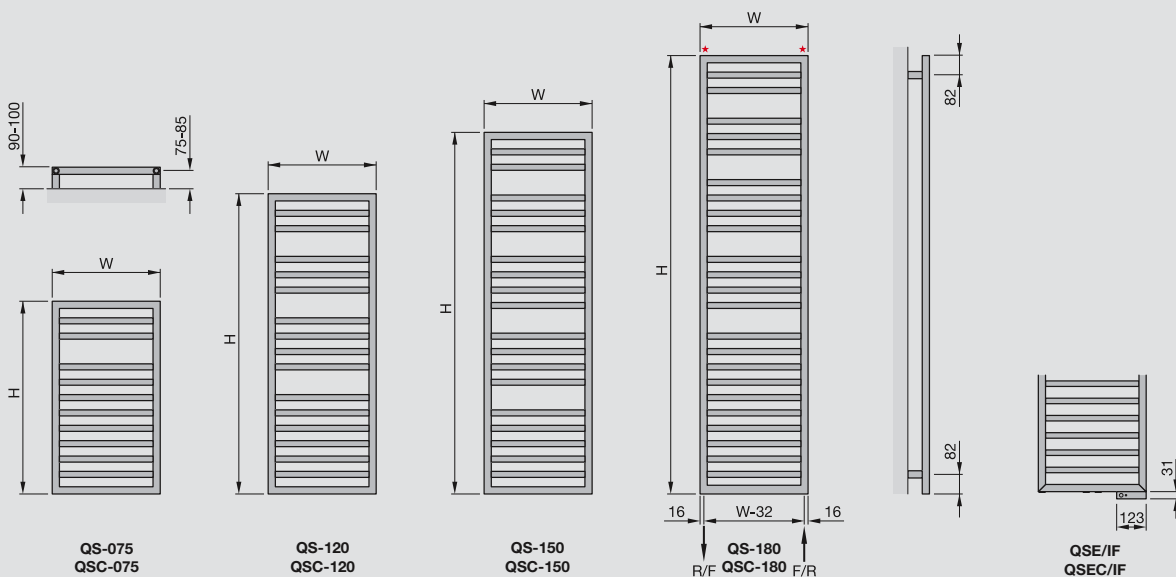

For full compliant technical specifications, refer to page 132
To make an approximate conversion from T=50K to T=60K multiply outputs by 1.2

Zehnder Vitalo Bar



The Zehnder Vitalo Bar has an incredibly slim 16mm profile and is manufactured from corrosion-resistant, top quality materials. Designed by King & Miranda, the Vitalo Bar is quick-responding, economical and gives a pleasant radiant heat via its innovative, award-winning construction.



Violet



White Aluminium



Beige Quartz



Caramel Quartz



Central Heating Model STOCK listed in black	Height mm	Width mm	Finish	Output $\Delta T=50K$ Watts/Btu All outputs certified to EN 442	Weight kg	RRP (ex VAT)	RRP (inc 20% VAT)
Zehnder Vitalo Bar							
VIP-125-040	1250	400	white	465/1586	7.0	£473	£567.60
VIP-125-050	1250	500	white	555/1893	8.7	£495	£594.00
VIP-125-060	1250	600	white	641/2186	10.5	£519	£622.80
VIP-160-040	1570	400	white	546/1862	9.3	£558	£669.60
VIP-160-050	1570	500	white	676/2305	11.4	£576	£691.20
VIP-160-060	1570	600	white	806/2748	13.6	£596	£715.20
VIP-190-040	1890	400	white	673/2295	10.9	£579	£694.80
VIP-190-050	1890	500	white	834/2844	12.7	£616	£739.20
VIP-190-060	1890	600	white	994/3390	14.6	£632	£758.40

Electric Heating Model	Height mm	Width mm	Finish	Electric Immersion Rating Watts with Safir Class II, IPX4 Zone 1 bath, Zone 2 shower	Weight kg	RRP (ex VAT)	RRP (inc 20% VAT)
Zehnder Vitalo Bar Electric							
VIPE-125-040/FF	1250	400	white	350	7.5	£604	£724.80
VIPE-160-040/FF	1570	400	white	500	10.0	£683	£819.60
VIPE-160-050/FF	1570	500	white	500	12.0	£698	£837.60
VIPE-190-040/FF	1890	400	white	500	12.0	£690	£828.00
VIPE-190-050/FF	1890	500	white	750	14.0	£734	£880.80
VIPE-190-060/FF	1890	600	white	1000	16.0	£778	£933.60

Colour finish: Standard colours from the Zehnder colour chart including matt white finish: white RAL 9016 + 25%. Colour finish and non-stock products delivery: 20-30 working days.
Suitable for all low temperature systems, heat pumps and condensing boilers, open and closed systems (<80°C)

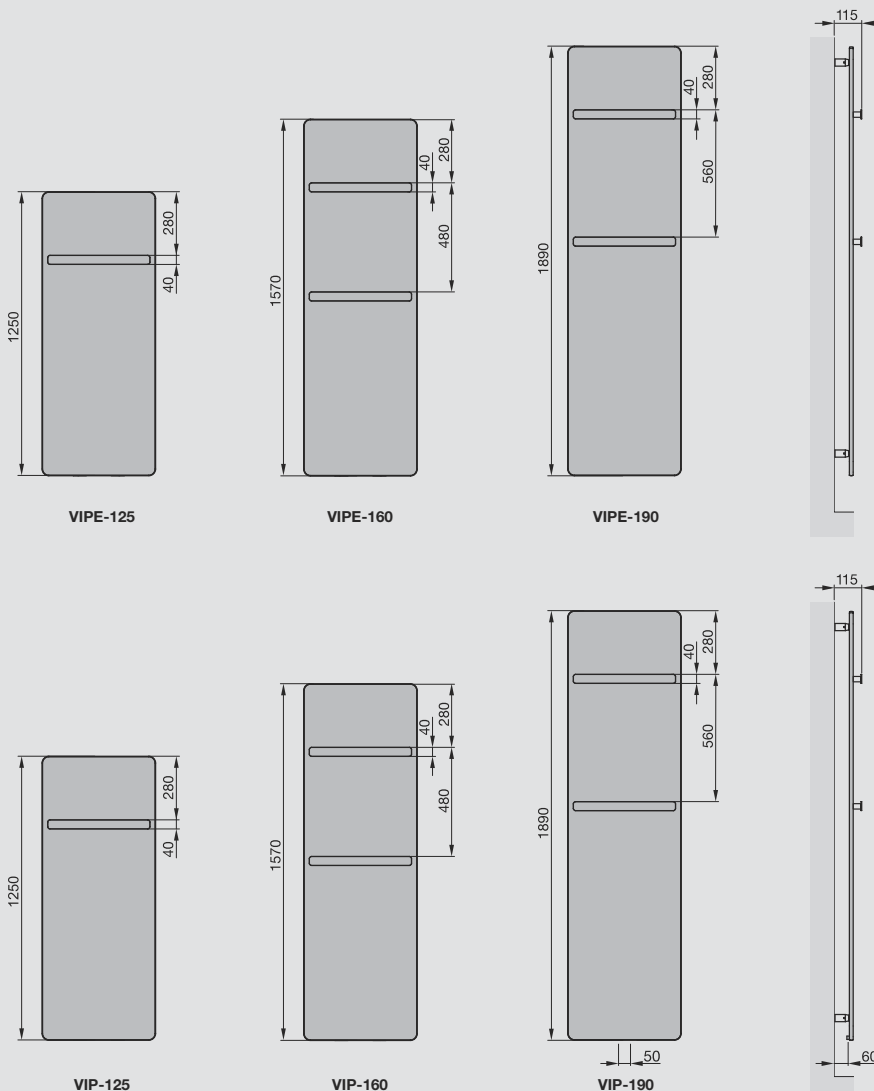

The aluminium honeycomb structure, with its meandering copper pipe, is filled with graphite, enabling heat to be distributed throughout the entire front of the radiator quickly and evenly. Suitable for all low temperature systems, heat pumps, condensing boilers, open or closed heating systems.

*1/2" air vent
Height includes air vent
F = flow
R = return
H = height
W = width
All dimensions in mm

For full compliant technical specifications, refer to page 132
To make an approximate conversion from T=50K to T=60K multiply outputs by 1.2

Zehnder Klaro



Affordable style combined with simplicity, suitable for central heating systems or with an immersion heater for summer use when the central heating is turned off.



Chrome



Valves: see page 122



Volcanic

Central Heating Model STOCK listed in black	Height mm	Width mm	Finish	Output $\Delta T=50K$ Watts/btu All outputs certified to EN 442	Electric Immersion Rating Watts	Weight kg	RRP (ex VAT)	RRP (inc 20% VAT)
Zehnder Klaro								
ZSL-080-045	748	450	white	354/1208	200	5.4	£111	£133.20
ZSL-080-050	748	500	white	388/1324	200	5.6	£114	£136.80
ZSL-080-060	748	600	white	455/1552	300	6.7	£122	£146.40
ZSL-120-045	1148	450	white	521/1778	300	8.1	£131	£157.20
ZSL-120-050	1148	500	white	571/1948	400	8.7	£134	£160.80
ZSL-120-060	1148	600	white	670/2286	500	9.8	£146	£175.20
ZSL-150-050	1466	500	white	716/2443	500	10.9	£167	£200.40
ZSL-150-060	1466	600	white	839/2863	500	12.3	£176	£211.20
ZSL-170-045	1708	450	white	751/2562	500	11.0	£182	£218.40
ZSL-170-050	1708	500	white	824/2811	500	12.2	£187	£224.40
ZSL-170-060	1708	600	white	966/3296	600	14.2	£192	£230.40
ZSL-080-045-0336	748	450	volcanic	354/1208	200	5.4	£139	£166.80
ZSL-120-050-0336	1148	500	volcanic	571/1948	400	8.7	£168	£201.60
ZSL-120-060-0336	1148	600	volcanic	670/2286	500	9.8	£183	£219.60
ZSL-150-050-0336	1466	500	volcanic	716/2443	500	10.9	£209	£250.80
ZSL-150-060-0336	1466	600	volcanic	839/2863	500	12.3	£220	£264.00
ZSL-170-050-0336	1708	500	volcanic	824/2811	500	12.2	£234	£280.80
ZSL-170-060-0336	1708	600	volcanic	966/3296	600	14.2	£240	£288.00
ZSL-080-045-0523	748	450	beige quartz	354/1208	200	5.4	£139	£166.80
ZSL-120-050-0523	1148	500	beige quartz	571/1948	400	8.7	£168	£201.60
ZSL-120-060-0523	1148	600	beige quartz	670/2286	500	9.8	£183	£219.60
ZSL-150-050-0523	1466	500	beige quartz	716/2443	500	10.9	£209	£250.80
ZSL-150-060-0523	1466	600	beige quartz	839/2863	500	12.3	£220	£264.00
ZSL-170-050-0523	1708	500	beige quartz	824/2811	500	12.2	£234	£280.80
ZSL-170-060-0523	1708	600	beige quartz	966/3296	600	14.2	£240	£288.00
ZSL-080-045-0529	748	450	brown quartz	354/1208	200	5.4	£139	£166.80
ZSL-120-050-0529	1148	500	brown quartz	571/1948	400	8.7	£168	£201.60
ZSL-120-060-0529	1148	600	brown quartz	670/2286	500	9.8	£183	£219.60
ZSL-150-050-0529	1466	500	brown quartz	716/2443	500	10.9	£209	£250.80
ZSL-150-060-0529	1466	600	brown quartz	839/2863	500	12.3	£220	£264.00
ZSL-170-050-0529	1708	500	brown quartz	824/2811	500	12.2	£234	£280.80
ZSL-170-060-0529	1708	600	brown quartz	966/3296	600	14.2	£240	£288.00
ZSLC-080-050	748	500	chrome	283/966	200	5.8	£246	£295.20
ZSLC-080-060	748	600	chrome	332/1133	200	6.7	£267	£320.40
ZSLC-120-050	1148	500	chrome	417/1423	300	8.7	£315	£378.00
ZSLC-120-060	1148	600	chrome	489/1668	300	9.8	£341	£409.20
ZSLC-150-050	1466	500	chrome	475/1621	300	10.5	£404	£484.80
ZSLC-150-060	1466	600	chrome	560/1911	400	12.1	£437	£524.40
ZSLC-170-050	1708	500	chrome	601/2050	400	12.2	£466	£559.20
ZSLC-170-060	1708	600	chrome	705/2405	500	14.2	£505	£606.00

Dual Energy: Self Fit - Additional cost to Central Heating model prices see page 128 for details

Colour finish: Standard colours from the Zehnder colour chart including matt white finish: white RAL 9016 + 25%. Colour finish and non-stock products delivery: 20-30 working days.

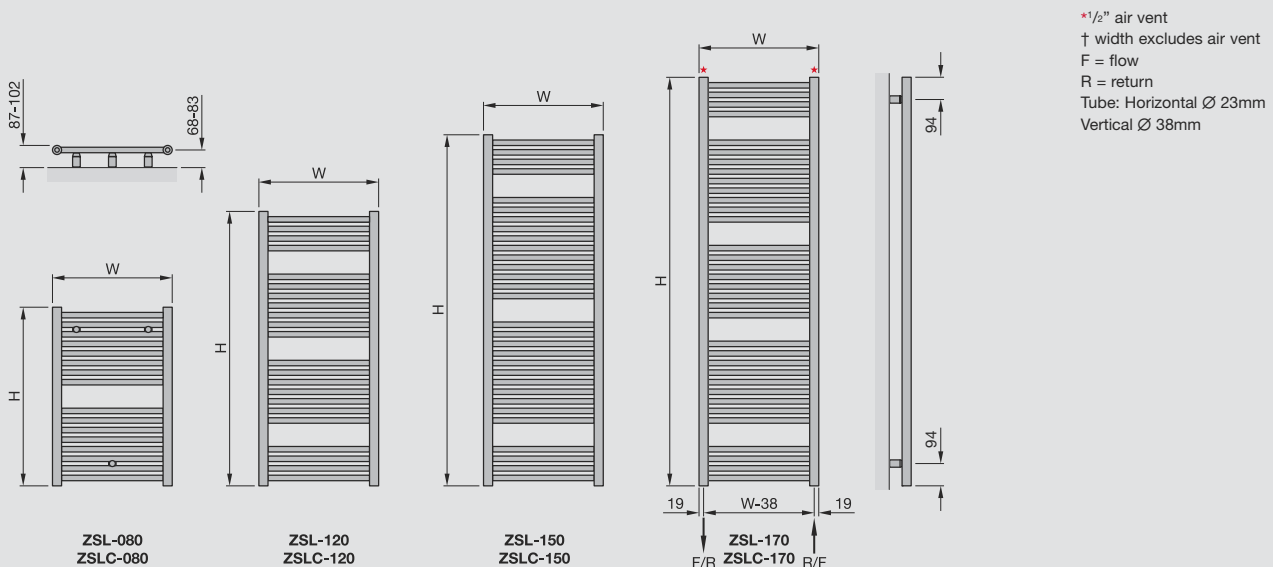

For full compliant technical specifications, refer to page 132
To make an approximate conversion from T=50K to T=60K multiply outputs by 1.2

Zehnder Klaro



The Zehnder Klaro electric range with its choice of immersion heaters and availability of colours offers a flexible solution to your bathroom heating requirements.



Volcanic



CE

Height mm	Width mm	Finish	Weight kg	Simple electric immersion heater Class II IPX4 Zones 1 and 2				DBM immersion heater Class II IPX4 Zones 1 and 2			
				Model STOCK listed in black	Electric rating	RRP (ex VAT)	RRP (inc 20% VAT)	Model STOCK listed in black	Electric rating	RRP (ex VAT)	RRP (inc 20% VAT)
⚡ Zehnder Klaro electric only models (with a choice of either a simple immersion heater (no controls) or the DBM immersion heater)											
748	450	white	9.00	ZSLE-080-045/F	200	£224	£268.80	ZSLE-080-045/DF	300	£275	£330.00
748	500	white	9.66	ZSLE-080-050/F	400	£227	£272.40	ZSLE-080-050/DF	300	£279	£334.80
748	600	white	11.00	ZSLE-080-060/F	400	£235	£282.00	ZSLE-080-060/DF	300	£290	£348.00
1148	500	white	14.53	ZSLE-120-050/F	400	£248	£297.60	ZSLE-120-050/DF	500	£301	£361.20
1148	600	white	16.43	ZSLE-120-060/F	500	£260	£312.00	ZSLE-120-060/DF	600	£314	£376.80
1466	500	white	17.8	ZSLE-150-050/F	500	£280	£336.00	ZSLE-150-050/DF	600	£333	£399.60
1466	600	white	20.5	ZSLE-150-060/F	600	£290	£348.00	ZSLE-150-060/DF	750	£343	£411.60
1708	500	white	20.67	ZSLE-170-050/F	600	£301	£361.20	ZSLE-170-050/DF	750	£355	£426.00
1708	600	white	23.80	ZSLE-170-060/F	600	£307	£368.40	ZSLE-170-060/DF	900	£360	£432.00
748	450	volcanic	9.00	ZSLE-080-045/F-0336	200	£280	£336.00	n/a	n/a	n/a	n/a
748	500	volcanic	9.66	ZSLE-080-050/F-0336	400	£284	£340.80	n/a	n/a	n/a	n/a
748	600	volcanic	11.00	ZSLE-080-060/F-0336	400	£294	£352.80	n/a	n/a	n/a	n/a
1148	500	volcanic	14.53	ZSLE-120-050/F-0336	400	£310	£372.00	n/a	n/a	n/a	n/a
1148	600	volcanic	16.43	ZSLE-120-060/F-0336	500	£325	£390.00	n/a	n/a	n/a	n/a
1708	500	volcanic	17.8	ZSLE-170-050/F-0336	600	£376	£451.20	n/a	n/a	n/a	n/a
1708	600	volcanic	20.5	ZSLE-170-060/F-0336	600	£384	£460.80	n/a	n/a	n/a	n/a
748	500	chrome	9.66	ZSLEC-080-050/F	200	£379	£454.80	ZSLEC-080-050/DF	200	£458	£549.60
748	600	chrome	11.00	ZSLEC-080-060/F	200	£402	£482.40	ZSLEC-080-060/DF	300	£479	£574.80
1148	500	chrome	14.53	ZSLEC-120-050/F	400	£449	£538.80	ZSLEC-120-050/DF	300	£540	£648.00
1148	600	chrome	16.43	ZSLEC-120-060/F	400	£474	£568.80	ZSLEC-120-060/DF	300	£565	£678.00
1466	500	chrome	17.8	ZSLEC-150-050/F	400	£538	£645.60	ZSLEC-150-050/DF	300	£627	£752.40
1466	600	chrome	20.5	ZSLEC-150-060/F	400	£571	£685.20	ZSLEC-150-060/DF	500	£661	£793.20
1708	500	chrome	20.67	ZSLEC-170-050/F	400	£600	£720.00	ZSLEC-170-050/DF	500	£691	£829.20
1708	600	chrome	23.80	ZSLEC-170-060/F	500	£639	£766.80	ZSLEC-170-060/DF	600	£728	£873.60

The immersion heater is fitted to the right hand header.

Note: Height does not include the immersion heater. (See diagrams below)

🎨 **Colour finish:** Standard colours from the Zehnder colour chart including matt white finish: white RAL 9016 + 25%. Colour finish and non-stock products delivery: 20-30 working days.

H = height
W = width
Tube: Horizontal Ø 23mm
Tube: Vertical Ø 38mm
All dimensions in mm

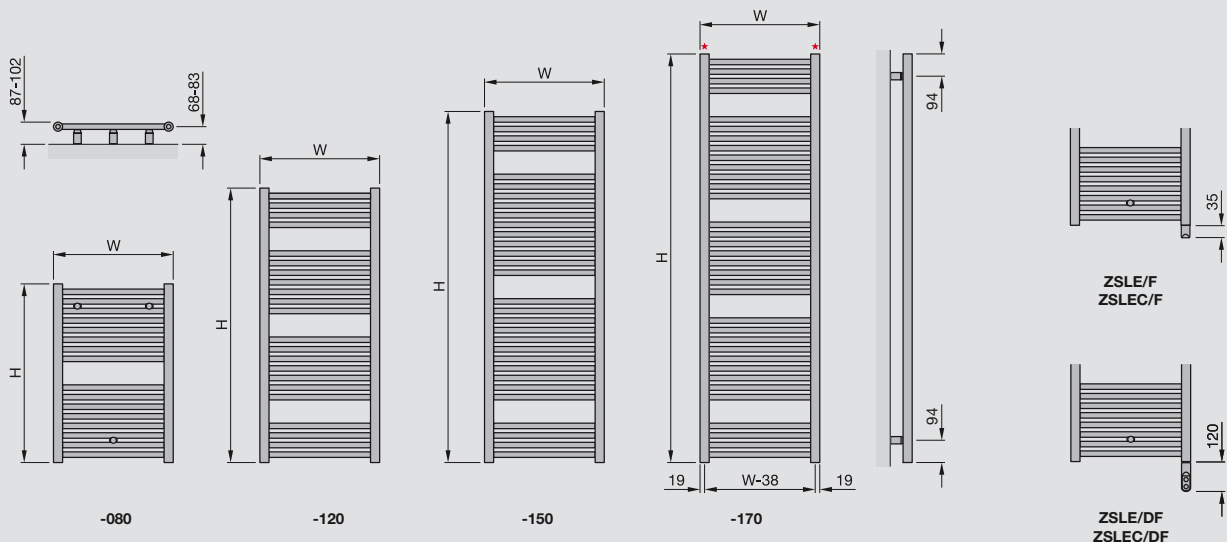

Zehnder Subway



The elegance and simplicity of the white and chrome Zehnder Subway are popular choices for modern bathrooms.



Volcanic



Stainless Steel: see page 64



Valves: see page 122



Central Heating Model STOCK listed in black	Height mm	Width mm	Finish	Output $\Delta T=50K$ Watts/btu All outputs certified to EN 442	Electric Immersion Rating Watts	Weight kg	RRP (ex VAT)	RRP (inc 20% VAT)
Zehnder Subway								
SUB-060-045	613	450	white	310/1058	200	5.2	£160	£192.00
SUB-100-045	973	450	white	401/1368	300	6.7	£172	£206.40
SUB-100-060	973	600	white	499/1703	300	8.3	£187	£224.40
SUB-130-045	1261	450	white	509/1737	300	8.6	£190	£228.00
SUB-130-060	1261	600	white	639/2180	400	10.5	£212	£254.40
SUB-150-045	1549	450	white	615/2098	400	10.6	£222	£266.40
SUB-150-060	1549	600	white	772/2634	500	12.5	£247	£296.40
SUB-180-045	1837	450	white	715/2440	500	12.2	£251	£301.20
SUB-180-060	1837	600	white	898/3064	600	14.7	£278	£333.60
SUBC-060-045	613	450	chrome	205/699	100	5.0	£347	£416.40
SUBC-100-045	973	450	chrome	265/904	200	6.5	£445	£534.00
SUBC-100-060	973	600	chrome	329/1123	200	8.1	£504	£604.80
SUBC-130-045	1261	450	chrome	335/1143	200	8.4	£505	£606.00
SUBC-130-060	1261	600	chrome	406/1385	300	10.2	£560	£672.00
SUBC-150-045	1549	450	chrome	420/1433	300	10.1	£595	£714.00
SUBC-150-060	1549	600	chrome	508/1733	300	12.3	£662	£794.40
SUBC-180-045	1837	450	chrome	485/1655	300	11.8	£665	£798.00
SUBC-180-060	1837	600	chrome	592/2020	400	14.3	£741	£889.20

Dual Energy: Self Fit - Additional cost to Central Heating model prices. See page 128 for details

Colour finish: Standard colours from the Zehnder colour chart including matt white finish: white RAL 9016 + 25%. Colour finish and non-stock products delivery: 20-30 working days.

Optional wall brackets: Increases space behind rail by 20mm

Model		RRP (ex VAT)	RRP (inc 20% VAT)
952111	Subway SUB extended bracket kit. White finish.	£37	£44.40
952118	Subway SUBC extended bracket kit. Chrome finish.	£37	£44.40
952119	Subway SUB extended bracket kit. Colour finish.	£37	£44.40

*1/2" air vent
Height excludes air vent
F = flow
R = return
H = height
W = width
Tube: Horizontal \varnothing 23mm
Tube: Vertical 30x30mm
All dimensions in mm

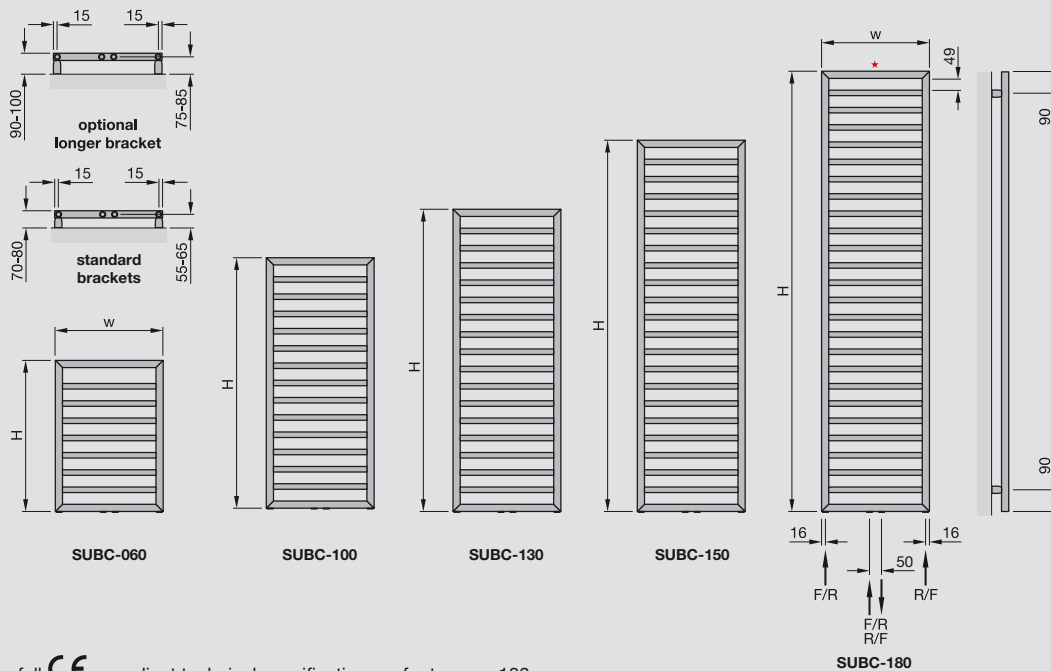

For full compliant technical specifications, refer to page 133
To make an approximate conversion from T=50K to T=60K multiply outputs by 1.2

Zehnder Subway



With its classic lines and broad appeal, the contemporary Zehnder Subway towel rail offers comfort and superb design in colour finishes, chrome and stainless steel.



Chrome



Stainless Steel: see page 62



Valves: see page 122



Central Heating Model STOCK listed in black	Height mm	Width mm	Finish	Output $\Delta T=50K$ Watts/btu All outputs certified to EN 442	Electric Immersion Rating Watts	Weight kg	RRP (ex VAT)	RRP (inc 20% VAT)
Zehnder Subway								
SUB-060-045-0336	613	450	volcanic	310/1058	200	5.2	£200	£240.00
SUB-100-045-0336	973	450	volcanic	401/1368	300	6.7	£215	£258.00
SUB-100-060-0336	973	600	volcanic	499/1703	300	8.3	£234	£280.80
SUB-130-045-0336	1261	450	volcanic	509/1737	300	8.6	£238	£285.60
SUB-130-060-0336	1261	600	volcanic	639/2180	400	10.5	£265	£318.00
SUB-150-060-0336	1549	600	volcanic	772/2634	500	12.5	£309	£370.80
SUB-180-045-0336	1837	450	volcanic	715/2440	500	14.7	£314	£376.80
SUB-060-045-0523	613	450	beige quartz	310/1058	200	5.2	£200	£240.00
SUB-100-045-0523	973	450	beige quartz	401/1368	300	6.7	£215	£258.00
SUB-100-060-0523	973	600	beige quartz	499/1703	300	8.3	£234	£280.80
SUB-130-045-0523	1261	450	beige quartz	509/1737	300	8.6	£238	£285.60
SUB-130-060-0523	1261	600	beige quartz	639/2180	400	10.5	£265	£318.00
SUB-150-060-0523	1549	600	beige quartz	772/2634	500	12.5	£309	£370.80
SUB-180-045-0523	1837	450	beige quartz	715/2440	500	14.7	£314	£376.80
SUB-060-045-0529	613	450	brown quartz	310/1058	200	5.2	£200	£240.00
SUB-100-045-0529	973	450	brown quartz	401/1368	300	6.7	£215	£258.00
SUB-100-060-0529	973	600	brown quartz	499/1703	300	8.3	£234	£280.80
SUB-130-045-0529	1261	450	brown quartz	509/1737	300	8.6	£238	£285.60
SUB-130-060-0529	1261	600	brown quartz	639/2180	400	10.5	£265	£318.00
SUB-150-060-0529	1549	600	brown quartz	772/2634	500	12.5	£309	£370.80
SUB-180-045-0529	1837	450	brown quartz	715/2440	500	14.7	£314	£376.80
SUB-060-045-0335	613	450	titane	310/1058	200	5.2	£200	£240.00
SUB-100-045-0335	973	450	titane	401/1368	300	6.7	£215	£258.00
SUB-100-060-0335	973	600	titane	499/1703	300	8.3	£234	£280.80
SUB-130-045-0335	1261	450	titane	509/1737	300	8.6	£238	£285.60
SUB-130-060-0335	1261	600	titane	639/2180	400	10.5	£265	£318.00
SUB-150-060-0335	1549	600	titane	772/2634	500	12.5	£309	£370.80
SUB-180-045-0335	1837	450	titane	715/2440	500	14.7	£314	£376.80

Dual Energy: Self Fit - Additional cost to Central Heating model prices. See page 128 for details

Colour finish: Standard colours from the Zehnder colour chart including matt white finish: white RAL 9016 + 25%. Colour finish and non-stock products delivery: 20-30 working days.

Optional wall brackets: Increases space behind rail by 20mm

Model	RRP (ex VAT)	RRP (inc 20% VAT)	
952119	Subway SUB extended bracket kit. Colour finish.	£37	£44.40

*1/2" air vent
Height excludes air vent
F = flow
R = return
H = height
W = width
Tube: Horizontal \varnothing 23mm
Tube: Vertical 30x30mm
All dimensions in mm

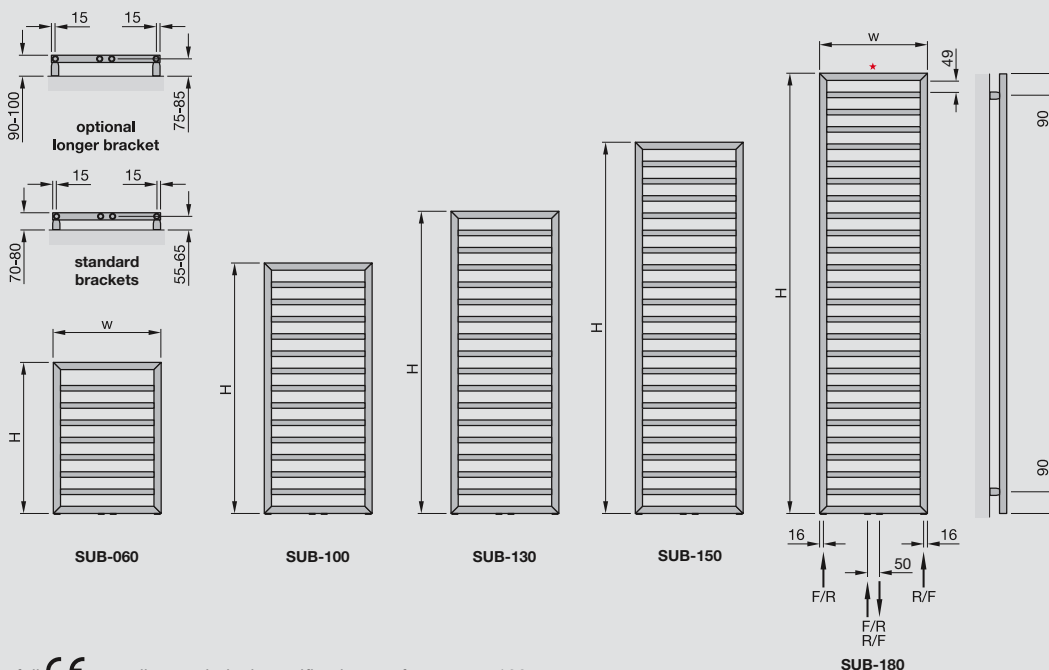

For full **CE** compliant technical specifications, refer to page 133
To make an approximate conversion from T=50K to T=60K multiply outputs by 1.2

Zehnder Subway



The simple elegance of the Subway in its electric form is maintained with either the infra-red receiver or a simple immersion heater.



Beige Quartz



Brown Quartz



Stainless Steel: see page 62



Safir Infra-red electric immersion heater control unit see page 129



Electric Heating Model STOCK listed in black	Height mm	Width mm	Finish	Simple Electric Immersion heater Rating Watts Class II IPX4 Zones 1 and 2	Weight kg	RRP (ex VAT)	RRP (inc 20% VAT)
⚡ Zehnder Subway Electric							
SUBE-130-045/F	1261	450	white	500	13.1	£259	£310.80
SUBE-150-045/F	1549	450	white	600	16.0	£300	£360.00
SUBE-150-060/F	1549	600	white	750	19.7	£327	£392.40
SUBE-180-060/F	1837	600	white	900	22.4	£363	£435.60
SUBEC-130-045/F	1261	450	chrome	300	12.9	£592	£710.40
SUBEC-150-045/F	1549	450	chrome	300	15.5	£691	£829.20
SUBEC-150-060/F	1549	600	chrome	500	19.5	£765	£918.00
SUBEC-180-060/F	1837	600	chrome	600	22.0	£851	£1,021.20

Electric Heating Model	Height mm	Width mm	Finish	Electric Immersion Rating Watts with Safir Class II, IPX4 Zone 1 bath, Zone 2 shower	Weight kg	RRP (ex VAT)	RRP (inc 20% VAT)
⚡ Zehnder Subway Electric							
SUBE-130-045/IF	1261	450	white	500	12.6	£467	£560.40
SUBE-150-045/IF	1549	450	white	600	15.3	£511	£613.20
SUBE-150-060/IF	1549	600	white	750	18.3	£562	£674.40
SUBE-180-060/IF	1837	600	white	900	21.3	£612	£734.40
SUBEC-130-045/IF	1351	450	chrome	300	12.6	£826	£991.20
SUBEC-150-045/IF	1549	450	chrome	300	15.3	£960	£1,152.00
SUBEC-150-060/IF	1549	600	chrome	500	18.3	£1,056	£1,267.20
SUBEC-180-060/IF	1837	600	chrome	600	21.3	£1,151	£1,381.20

Simple Electric Immersion heating has Safir casing without infra red control included.

The immersion heater is fitted to the right hand header.

Note: Height does not include the immersion heater. (See diagrams below)

⚙️ Colour finish: Standard colours from the Zehnder colour chart including matt white finish: white RAL 9016 + 25%. Colour finish and non-stock products delivery: 20-30 working days.

H = height
W = width
Tube: Horizontal Ø 23mm
Tube: Vertical 30x30mm
All dimensions in mm

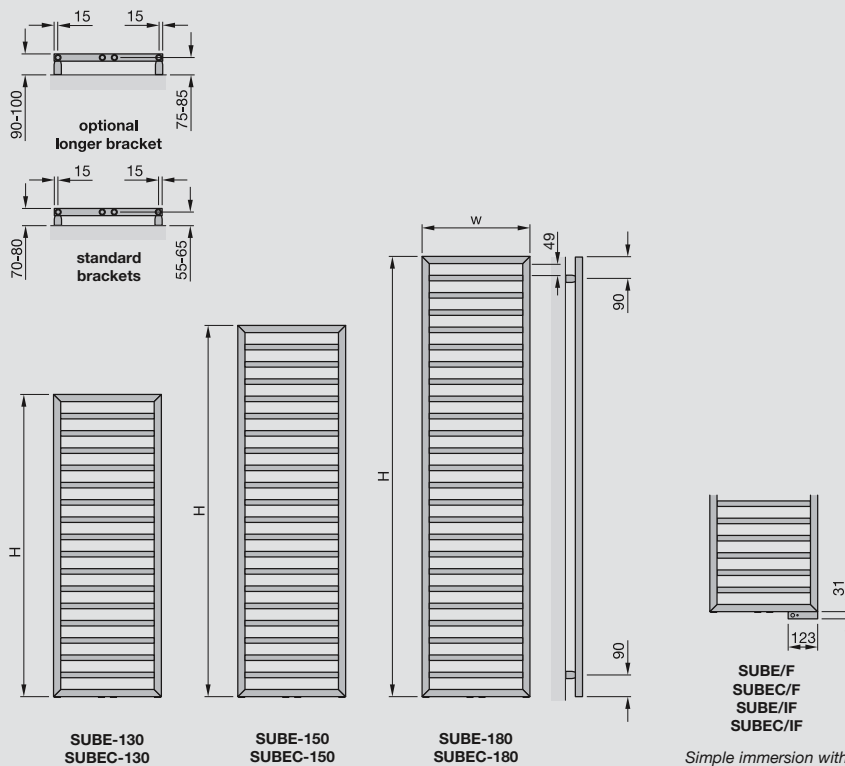

Zehnder Sfera Bow



The sophisticated elegance and gently curved, slender tubes of the Zehnder Sfera Bow combines aesthetic appeal with efficient drying space.



Towel ring not included: see page 121 for accessories



Valves: see page 122



Safir Infra-red electric immersion heater control unit see page 129



Central Heating Model STOCK listed in black	Height mm	Width mm	Finish	Output $\Delta T=50K$ Watts/btu All outputs certified to EN 442	Electric Immersion Rating Watts	Weight kg	RRP (ex VAT)	RRP (inc 20% VAT)
🔥 Zehnder Sfera Bow NEW anthracite and beige quartz finish now stocked								
SH-086-050	859	498	white	460/1569	300	8.0	£162	£194.40
SH-086-060	859	593	white	554/1890	300	9.2	£183	£219.60
SH-126-050	1255	498	white	710/2423	500	12.5	£187	£224.40
SH-126-060	1255	593	white	850/2900	600	14.4	£207	£248.40
SH-175-050	1750	498	white	946/3228	600	17.3	£248	£297.60
SH-175-060	1750	593	white	1126/3841	750	19.8	£271	£325.20
SH-086-050-0346	859	498	anthracite	460/1569	300	8.0	£203	£243.60
SH-086-060-0346	859	593	anthracite	554/1890	300	9.2	£229	£274.80
SH-126-050-0346	1255	498	anthracite	710/2423	500	12.5	£234	£280.80
SH-126-060-0346	1255	593	anthracite	850/2900	600	14.4	£259	£310.80
SH-175-050-0346	1750	498	anthracite	946/3228	600	17.3	£310	£372.00
SH-175-060-0346	1750	593	anthracite	1126/3841	750	19.8	£339	£406.80
SH-086-050-0523	859	498	beige quartz	460/1569	300	8.0	£203	£243.60
SH-086-060-0523	859	593	beige quartz	554/1890	300	9.2	£229	£274.80
SH-126-050-0523	1255	498	beige quartz	710/2423	500	12.5	£234	£280.80
SH-126-060-0523	1255	593	beige quartz	850/2900	600	14.4	£259	£310.80
SH-175-050-0523	1750	498	beige quartz	946/3228	600	17.3	£310	£372.00
SH-175-060-0523	1750	593	beige quartz	1126/3841	750	19.8	£339	£406.80
SHC-086-050	859	498	chrome	316/1078	200	8.0	£305	£366.00
SHC-086-060	859	593	chrome	350/1194	200	9.2	£344	£412.80
SHC-126-050	1255	498	chrome	476/1624	300	12.5	£369	£442.80
SHC-126-060	1255	593	chrome	573/1955	300	14.4	£413	£495.60
SHC-175-050	1750	498	chrome	650/2218	500	17.3	£530	£636.00
SHC-175-060	1750	593	chrome	775/2644	500	19.8	£593	£711.60

⚡ Dual Energy: Self Fit - Additional cost to Central Heating model: see page 128 for details

Height mm	Width mm	Finish	Weight kg	Simple electric immersion heater Class II IPX4 Zones 1 and 2				Electric Immersion Rating Watts with Safir Class II, IPX4 Zone 1 bath, Zone 2 shower			
				Model	Electric rating	RRP (ex VAT)	RRP (inc 20% VAT)	Model	Electric rating	RRP (ex VAT)	RRP (inc 20% VAT)

⚡ Zehnder Sfera Bow electric only models with a choice of either a simple immersion heater (no controls) or the Safir remote thermostatic controller.

859	498	white	13	SHE-086-050/F	300	£199	£238.80	SHE-086-050/IF2	300	£248	£297.60
859	593	white	15	SHE-086-060/F	300	£219	£262.80	SHE-086-060/IF2	300	£269	£322.80
1255	498	white	18.5	SHE-126-050/F	500	£225	£270.00	SHE-126-050/IF2	500	£288	£345.60
1255	593	white	22	SHE-126-060/F	600	£246	£295.20	SHE-126-060/IF2	600	£298	£357.60
1750	498	white	26	SHE-175-050/F	750	£286	£343.20	SHE-175-050/IF2	750	£338	£405.60
1750	593	white	29.7	SHE-175-060/F	900	£310	£372.00	SHE-175-060/IF2	900	£370	£444.00
1255	498	chrome	19.5	SHEC-126-050/F	300	£412	£494.40	SHEC-126-050/IF2	300	£501	£601.20
1255	593	chrome	23	SHEC-126-060/F	300	£457	£548.40	SHEC-126-060/IF2	300	£545	£654.00
1750	498	chrome	26	SHEC-175-050/F	500	£575	£690.00	SHEC-175-050/IF2	500	£650	£780.00
1750	593	chrome	29.5	SHEC-175-060/F	600	£638	£765.60	SHEC-175-060/IF2	600	£713	£855.60

Simple Electric Immersion heating has Safir casing without infra red control included.

The immersion heater is fitted to the right hand header.

Note: Height does not include the immersion heater. (See diagrams below)

🎨 Colour finish: Standard colours from the Zehnder colour chart including matt white finish: white RAL 9016 + 25%. Colour finish and non-stock products delivery: 20-30 working days.

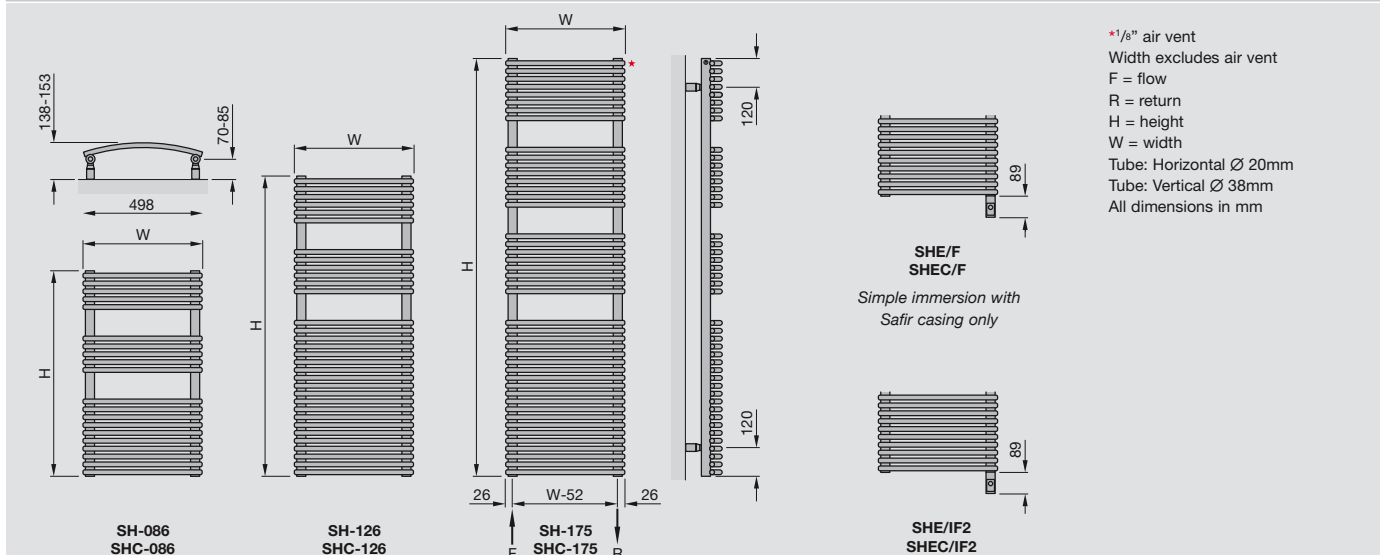

For full **CE** compliant technical specifications, refer to page 133

Zehnder Yucca Asym



Beautiful, practical and available single or double tubed, in white, colour or chrome, the Zehnder Yucca Asym can also be installed perpendicular to the wall to create a partition.



Zehnder Yucca as a room divider



Short cover plate for Yucca valve see page 123



Valves: see page 122



Central Heating Model STOCK listed in black	Height mm	Width mm	Finish	Output $\Delta T=50K$ Watts/btu All outputs certified to EN 442	Electric Immersion Rating Watts	Weight kg	RRP (ex VAT)	RRP (inc 20% VAT)
🔥 Zehnder Yucca Asym Single (Horizontal tubes on left or right)								
YA-090-050	872	478	white	351/1197	200	9.2	£323	£387.60
YA-130-040	1304	378	white	430/1466	300	11.3	£428	£513.60
YA-130-050	1304	478	white	517/1763	300	13.6	£435	£522.00
YA-130-060	1304	578	white	599/2043	400	15.9	£446	£535.20
YA-170-040	1736	378	white	571/1947	400	15.0	£434	£520.80
YA-170-050	1736	478	white	686/2339	500	18.1	£470	£564.00
YA-170-060	1736	578	white	795/2711	500	21.1	£479	£574.80
YAC-090-050	872	478	chrome	254/866	150	9.2	£908	£1,089.60
YAC-130-040	1304	378	chrome	308/1050	200	11.3	£962	£1,154.40
YAC-130-050	1304	478	chrome	371/1265	200	13.6	£991	£1,189.20
YAC-130-060	1304	578	chrome	432/1473	300	15.9	£999	£1,198.80
YAC-170-040	1736	378	chrome	408/1391	300	15.0	£1,069	£1,282.80
YAC-170-050	1736	478	chrome	492/1678	300	18.1	£1,091	£1,309.20
YAC-170-060	1736	578	chrome	572/1951	300	21.1	£1,108	£1,329.60

🔥 Zehnder Yucca Asym Double (Not available in chrome. Horizontal tubes on left or right)								
YAD-130-040	1304	378	white	628/2141	400	19.7	£521	£625.20
YAD-130-060	1304	578	white	893/3045	600	28.9	£535	£642.00
YAD-170-040	1736	378	white	825/2813	500	26.2	£584	£700.80
YAD-170-050	1736	478	white	1002/3417	600	32.3	£671	£805.20
YAD-170-060	1736	578	white	1173/4000	750	38.4	£715	£858.00

⚡ Dual Energy: Self Fit - (Additional cost to Central Heating model prices) See page 128 for details

Electric Heating Model	Height mm	Width mm	Finish	Electric Immersion Rating (Watts) with factory fitted Ivvar Class I, IPX5, VDE, CE (Suitable for zone 1)	Weight kg	RRP (ex VAT)	RRP (inc 20% VAT)
------------------------	-----------	----------	--------	---	-----------	--------------	-------------------

⚡ Zehnder Yucca Asym Single Electric (Horizontal tubes on right)							
YAER-130-040/RG	1492	378	white	300	15.5	£850	£1,020.00
YAER-170-050/RG	1924	478	white	600	24.3	£1,022	£1,226.40
YAEER-130-040/RG	1492	378	chrome	300	15.5	£1,436	£1,723.20
YAEER-170-050/RG	1924	478	chrome	300	24.3	£1,660	£1,992.00

Horizontal tubes on right-hand side, element in left-hand header. If alternative is required specify at time of order.

🎨 Colour finish: Standard colours from the Zehnder colour chart including matt white finish: white RAL 9016 + 25%. Colour finish and non-stock products delivery: 20-30 working days.

Accessories			
Model		RRP (ex VAT)	RRP (inc 20% VAT)
Room divider bracket (to be ordered with radiator where required)			
936011	white	£86	£103.20
936018	chrome	£122	£146.40
936019 + colour code	colour	£108	£129.60
Special lengths brackets made to order (price on application)			

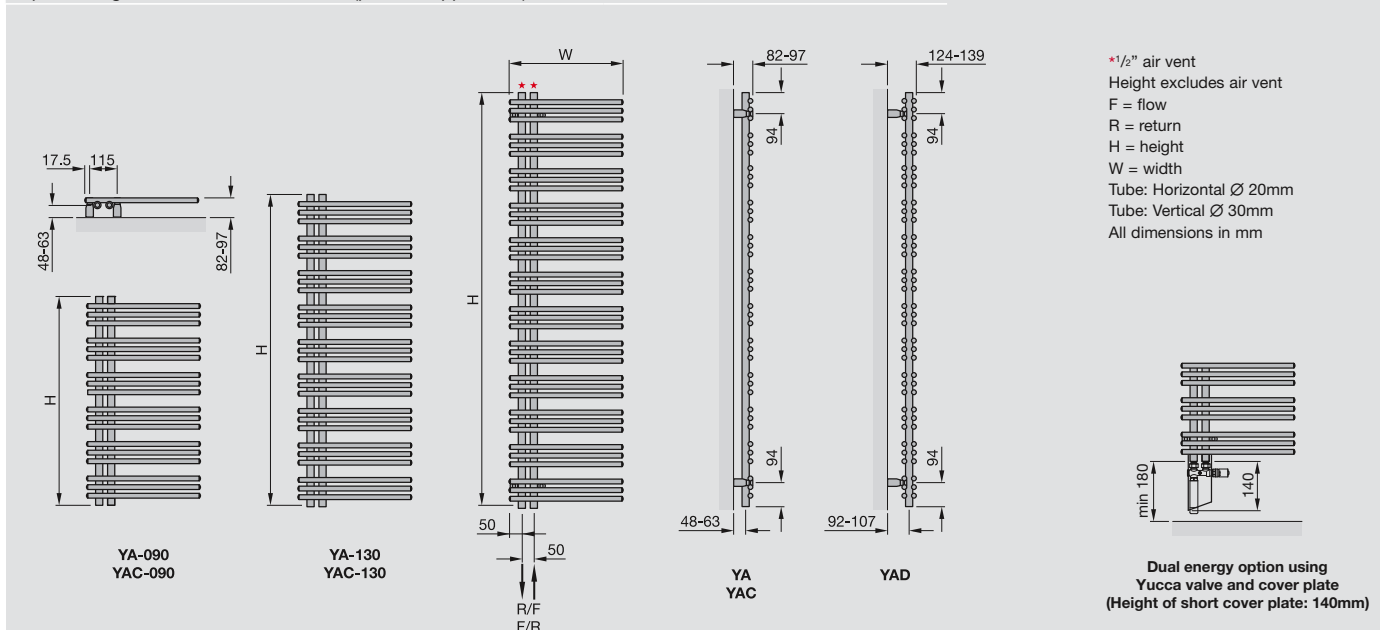

For full **CE** compliant technical specifications, refer to page 134
To make an approximate conversion from T=50K to T=60K multiply outputs by 1.2

Zehnder Yucca Sym



A celebrated patented design, the stunning Zehnder Yucca is available single or double-tubed in white and colour, and single-tubed in chrome.



Irvar electric immersion:
see page 129



Yucca valve with short
cover plate: see page 123



Valves: see page 122



Central Heating Model STOCK listed in black	Height mm	Width mm	Finish	Output $\Delta T=50K$ Watts/btu All outputs certified to EN 442	Electric Immersion Rating Watts	Weight kg	RRP (ex VAT)	RRP (inc 20% VAT)
🔥 Zehnder Yucca Sym Single								
YS-090-050	908	500	white	324/1105	200	8.4	£332	£398.40
YS-130-050	1340	500	white	477/1628	300	12.6	£420	£504.00
YS-130-060	1340	600	white	541/1846	300	14.2	£445	£534.00
YS-130-080	1340	800	white	661/2255	500	17.2	£484	£580.80
YS-180-050	1772	500	white	621/2119	400	16.8	£476	£571.20
YS-180-060	1772	600	white	706/2409	500	18.8	£491	£589.20
YS-180-080	1772	800	white	863/2945	600	22.9	£534	£640.80
YSC-090-050	908	500	chrome	229/781	150	8.4	£917	£1,100.40
YSC-130-050	1340	500	chrome	330/1125	200	12.6	£962	£1,154.40
YSC-130-060	1340	600	chrome	377/1286	300	14.2	£1,042	£1,250.40
YSC-130-080	1340	800	chrome	465/1586	300	17.2	£1,099	£1,318.80
YSC-180-050	1772	500	chrome	431/1470	300	16.8	£1,024	£1,228.80
YSC-180-060	1772	600	chrome	493/1681	300	18.8	£1,112	£1,334.40
YSC-180-080	1772	800	chrome	608/2073	400	22.9	£1,162	£1,394.40

🔥 Zehnder Yucca Sym Double (not available in chrome)								
YSD-130-050	1340	500	white	717/2446	500	22.3	£506	£607.20
YSD-130-060	1340	600	white	823/2808	500	25.3	£565	£678.00
YSD-130-080	1340	800	white	1024/3494	600	31.4	£613	£735.60
YSD-180-050	1772	500	white	926/3159	600	29.6	£591	£709.20
YSD-180-060	1772	600	white	1063/3627	600	33.7	£705	£846.00
YSD-180-080	1772	800	white	1322/4511	900	41.8	£752	£902.40

⚡ Dual Energy: Self Fit - (Additional cost to Central Heating model prices) See page 128 for details

Electric Heating Model	Height mm	Width mm	Finish	Electric Immersion Rating (Watts) with factory fitted Irvar Class I, IPX5, VDE, CE (Suitable for zone 1)	Weight kg	RRP (ex VAT)	RRP (inc 20% VAT)
⚡ Zehnder Yucca Sym Single Electric							
YSE-130-050/RG	1492	500	white	300	17.1	£921	£1,105.20
YSE-180-060/RG	1924	600	white	600	25.3	£1,102	£1,322.40
YSEC-130-050/RG	1492	500	chrome	300	17.1	£1,491	£1,789.20
YSEC-180-060/RG	1924	600	chrome	300	25.3	£1,683	£2,019.60

🎨 Colour finish: Standard colours from the Zehnder colour chart including matt white finish: white RAL 9016 + 25%. Colour finish and non-stock products delivery: 20-30 working days.

Delivery non-stock products: 7-10 working days. Electric: 15-20 working days.

*1/2" air vent
Height excludes air vent
F = flow
R = return
H = height
W = width
Tube: Horizontal \varnothing 20mm
Tube: Vertical \varnothing 30mm
All dimensions in mm

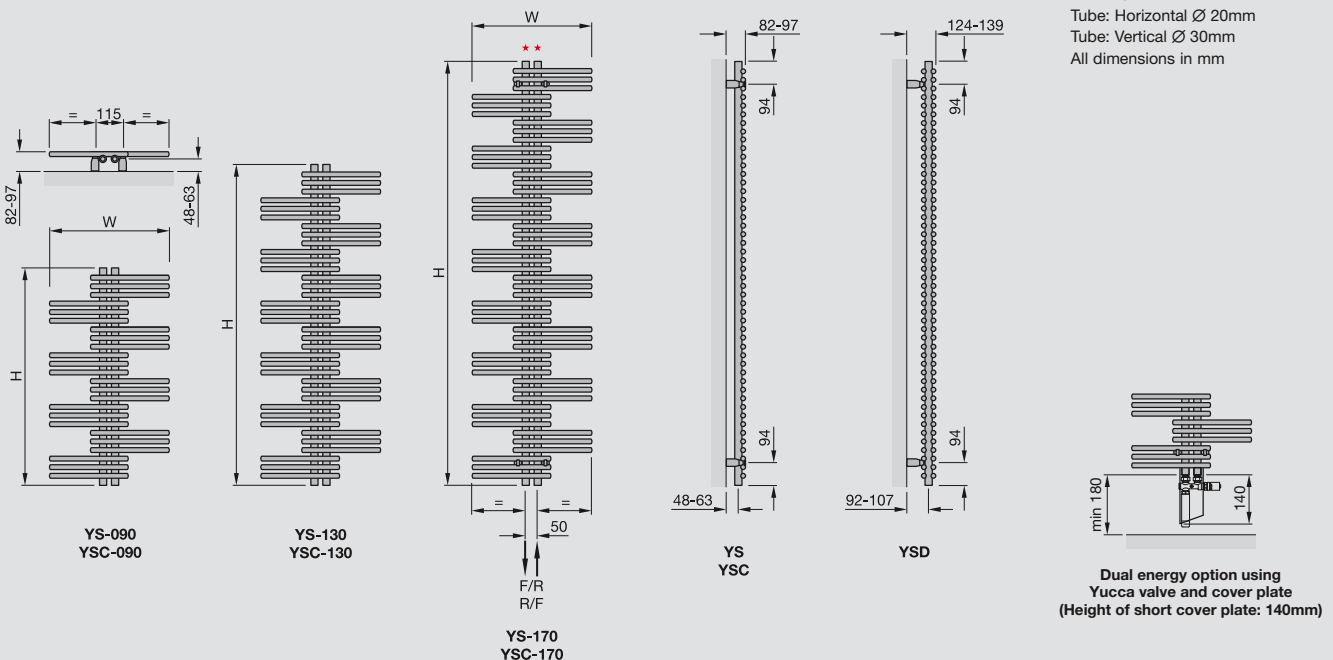

For full **CE** compliant technical specifications, refer to page 134
To make an approximate conversion from T=50K to T=60K multiply outputs by 1.2

Zehnder Metropolitan Spa



The Zehnder Metropolitan Spa towel radiator brings an elegant, spa style to modern bathrooms and kitchens. Connections and air vents are neatly hidden to maintain the formality and purity of the design. Geometric cut-outs create an attractive shape with plenty of space for towels to dry.



White Quartz



Also available as a room radiator see page 82



METE, METM Infrared immersion sensor



Orange Quartz

Central Heating Model STOCK listed in black	Height mm	Width mm	Finish	Output $\Delta T=50K$ Watts/btu All outputs certified to EN 442	Electric Immersion Rating Watts	Weight kg	RRP (ex VAT)	RRP (inc 20% VAT)
Zehnder Metropolitan Spa								
MET-080-040	805	400	white	327/1115	250	6.5	£311	£373.20
MET-080-050	805	500	white	388/1324	300	7.8	£317	£380.40
MET-080-060	805	600	white	445/1518	300	9.1	£328	£393.60
MET-120-040	1225	400	white	474/1617	300	9.8	£387	£464.40
MET-120-050	1225	500	white	561/1914	400	11.7	£396	£475.20
MET-120-060	1225	600	white	645/2201	400	13.5	£409	£490.80
MET-150-040	1540	400	white	582/1986	400	11.5	£459	£550.80
MET-150-050	1540	500	white	690/2354	500	13.5	£468	£561.60
MET-180-050	1750	500	white	775/2644	500	16.3	£523	£627.60
MET-180-060	1750	600	white	889/3033	600	19.0	£539	£646.80

Dual Energy Heating Model	Height mm	Width mm	Output $\Delta T=50K$ Watts/btu All outputs certified to EN 442	With factory-fitted Safir Class II IPX4-IPK09 (suitable for Zone 1 bath, Zone 2 shower) Electric Rating (Watts)	Weight kg	RRP (ex VAT)	RRP (inc 20% VAT)
---------------------------	-----------	----------	---	--	-----------	--------------	-------------------

Zehnder Metropolitan Spa Dual energy (factory fitted) White RAL 9016							
METM-080-040/IF	805	400	327/1115	300	7.0	£559	£670.80
METM-120-040/IF	1225	400	474/1617	500	10.3	£621	£745.20
METM-120-050/IF	1225	500	561/1914	500	12.2	£635	£762.00
METM-120-060/IF	1225	600	645/2201	600	14.0	£654	£784.80
METM-150-050/IF	1540	500	690/2354	600	14.0	£711	£853.20
METM-150-060/IF	1540	600	792/2702	750	16.1	£732	£878.40
METM-180-050/IF	1750	500	775/2644	750	16.8	£761	£913.20

Electric Heating Model	Height mm	Width mm	Finish	With factory-fitted Safir Class II IPX4-IPK09 (suitable for Zone 1 bath, Zone 2 shower) Electric Rating (Watts)	Weight kg	RRP (ex VAT)	RRP (inc 20% VAT)
------------------------	-----------	----------	--------	--	-----------	--------------	-------------------

Zehnder Metropolitan Spa Electric							
METE-080-040/IF	805	400	white	300	9.4	£577	£692.40
METE-120-040/IF	1225	400	white	500	13.8	£634	£760.80
METE-120-050/IF	1225	500	white	500	16.0	£646	£775.20
METE-120-060/IF	1225	600	white	600	18.3	£666	£799.20
METE-150-050/IF	1540	500	white	600	18.5	£725	£870.00
METE-150-060/IF	1540	600	white	750	21.1	£746	£895.20
METE-180-050/IF	1750	500	white	750	22.4	£776	£931.20

Accessories			
Model		RRP (ex VAT)	RRP (inc 20% VAT)
468038	Towel-bar for 400 mm width radiator, chrome plated	£89	£106.80
468048	Towel-bar for 500 mm width radiator, chrome plated	£91	£109.20
468058	Towel-bar for 600 mm width radiator, two fixing points, chrome plated	£94	£112.80
480438	Set of hooks (2 pcs.), to clip on, chrome plated	£40	£48.00

Colour finish: Standard colours from the Zehnder colour chart including matt white finish: white RAL 9016 + 25%. Colour finish and non-stock products delivery: 20-30 working days.

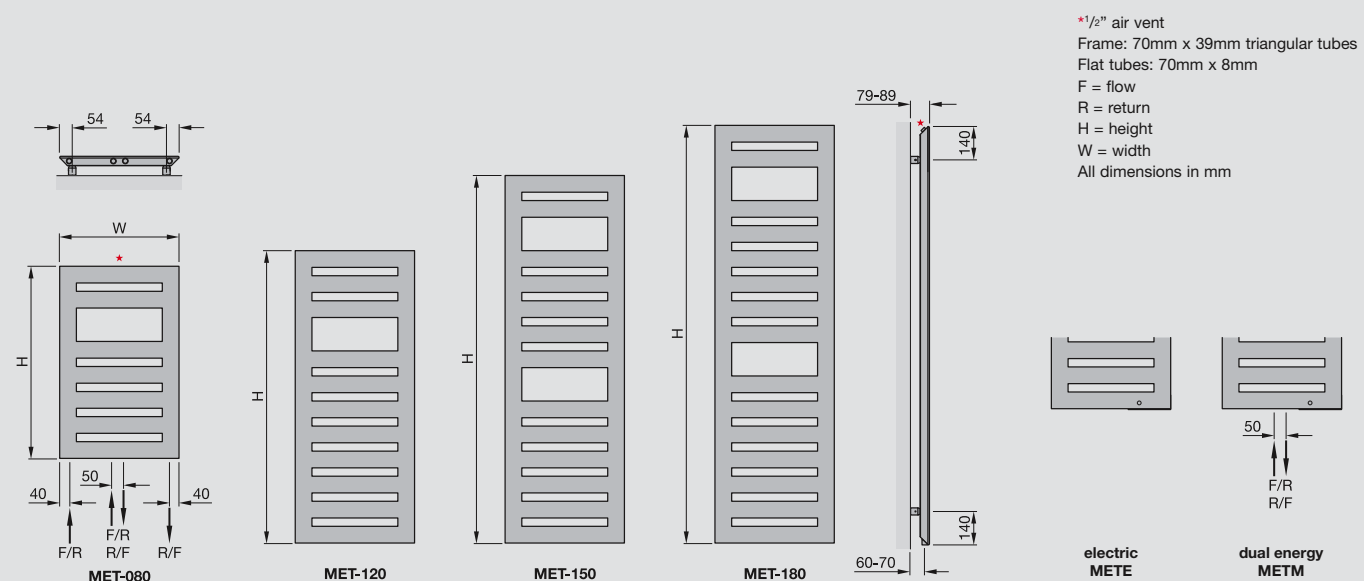

For full **CE** compliant technical specifications, refer to page 135
 To make an approximate conversion from T=50K to T=60K multiply outputs by 1.2

Zehnder Ax Spa



With its single or double tube options, the unique Zehnder Ax Spa can meet all bathroom-heating requirements. It is also available as an oil-filled electric radiator.



Ax Spa



Valves: see page 122



Volcanic

Central Heating Model STOCK listed in black	Height mm	Width mm	Finish	Output $\Delta T=50K$ Watts/btu All outputs certified to EN 442	Electric Immersion Rating Watts	Weight kg	RRP (ex VAT)	RRP (inc 20% VAT)
Zehnder Ax Spa Single tube (Cloakroom size - see pages 8/9)								
ZA-048-040	484	400	white	230/785	n/a	4.5	£162	£194.40
ZA-048-040-0336	484	400	volcanic	230/785	n/a	4.5	£202	£242.40
ZA-048-040-0523	484	400	beige quartz	230/785	n/a	4.5	£202	£242.40
ZA-048-040-0529	484	400	brown quartz	230/785	n/a	4.5	£202	£242.40

Zehnder Ax Spa Single tube								
ZA-060-080	575	800	white	458/1563	300	10.2	£345	£414.00
ZA-060-090	575	900	white	515/1757	300	11.3	£388	£465.60
ZA-060-100	575	1000	white	573/1955	300	12.4	£430	£516.00
ZA-060-120	575	1200	white	687/2344	500	14.5	£515	£618.00
ZA-080-050	836	500	white	427/1457	300	8.6	£367	£440.40
ZA-120-050	1188	500	white	586/1999	300	12.0	£444	£532.80
ZA-120-060	1188	600	white	685/2337	500	13.7	£491	£589.20
ZA-150-040	1540	400	white	614/2095	400	12.3	£496	£595.20
ZA-150-050	1540	500	white	738/2518	500	14.4	£528	£633.60
ZA-180-050	1804	500	white	884/3016	600	18.6	£634	£760.80
ZA-060-080-0336	575	800	volcanic	458/1563	300	10.2	£431	£517.20
ZA-060-090-0336	575	900	volcanic	515/1757	300	11.3	£485	£582.00
ZA-060-100-0336	575	1000	volcanic	573/1955	300	12.4	£538	£645.60
ZA-060-120-0336	575	1200	volcanic	687/2344	500	14.5	£644	£772.80
ZA-060-080-0523	575	800	beige quartz	458/1563	300	10.2	£431	£517.20
ZA-060-090-0523	575	900	beige quartz	515/1757	300	11.3	£485	£582.00
ZA-060-100-0523	575	1000	beige quartz	573/1955	300	12.4	£538	£645.60
ZA-060-120-0523	575	1200	beige quartz	687/2344	500	14.5	£644	£772.80
ZA-060-080-0529	575	800	brown quartz	458/1563	300	10.2	£431	£517.20
ZA-060-090-0529	575	900	brown quartz	515/1757	300	11.3	£485	£582.00
ZA-060-100-0529	575	1000	brown quartz	573/1955	300	12.4	£538	£645.60
ZA-060-120-0529	575	1200	brown quartz	687/2344	500	14.5	£644	£772.80

Zehnder Ax Spa Double tube								
ZAD-150-050	1540	500	white	1049/3579	n/a	25.3	£786	£943.20
ZAD-180-050	1804	500	white	1262/4306	n/a	30.5	£988	£1,185.60
ZAD-180-060	1804	600	white	1485/5067	n/a	35.6	£1,059	£1,270.80

Projection: 97-112mm

Dual energy: Self fit - (additional cost to central heating model prices). Not available for ZAD See page 128 for details.

Colour finish: Standard colours from the Zehnder colour chart including matt white finish: white RAL 9016 + 25%. Colour finish and non-stock products delivery: 20-30 working days.

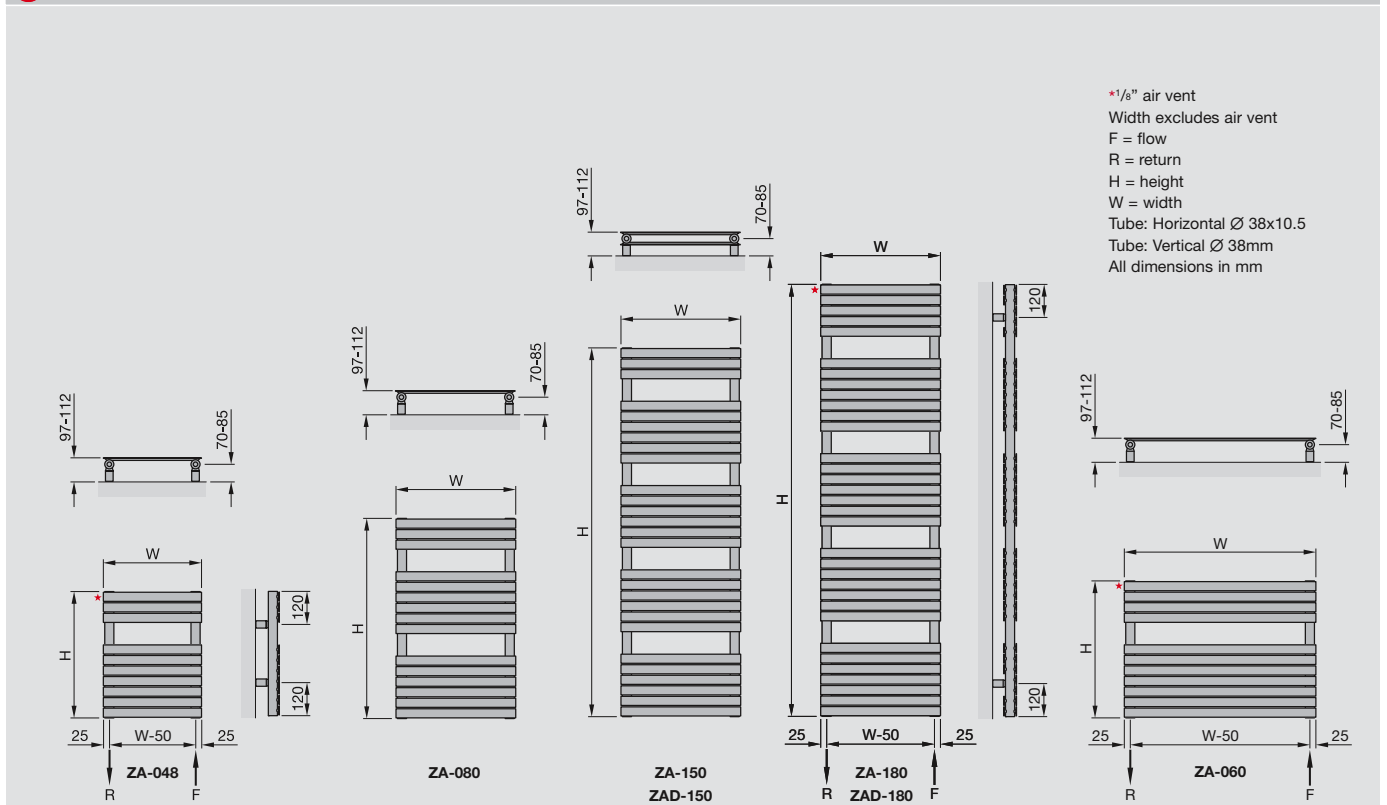

For full **CE** compliant technical specifications, refer to page 135
To make an approximate conversion from T=50K to T=60K multiply outputs by 1.2

Zehnder Ax Spa



The Ax Spa is now available in modern chrome as well as a range of contemporary colours. The electric version offers a flexible bathroom heating solution for the summer months.



Ax Spa



Safir Infra-red electric immersion heater control unit see page 129



Central Heating Model STOCK listed in black	Height mm	Width mm	Finish	Output $\Delta T=50K$ Watts/btu All outputs certified to EN 442	Electric Immersion Rating Watts	Weight kg	RRP (ex VAT)	RRP (inc 20% VAT)
Zehnder Ax Spa Single tube								
ZAC-080-050	836	500	chrome	300/1024	300	8.6	£524	£628.80
ZAC-120-050	1188	500	chrome	410/1399	300	12.0	£696	£835.20
ZAC-120-060	1188	600	chrome	480/1638	500	13.7	£756	£907.20
ZAC-150-040	1540	400	chrome	430/1467	400	12.3	£788	£945.60
ZAC-150-050	1540	500	chrome	520/1774	500	14.4	£825	£990.00
ZAC-180-050	1804	500	chrome	620/2115	600	18.6	£998	£1,197.60

Electric Heating Model 15-20 days	Height mm	Width mm	Finish	Electric Immersion Rating Watts with Safir Class II, IPX4 Zone 1 bath, Zone 2 shower	Weight kg	RRP (ex VAT)	RRP (inc 20% VAT)
-----------------------------------	-----------	----------	--------	---	-----------	--------------	-------------------

Zehnder Ax Spa Electric							
ZAE-120-050/IF	1277	500	white	500	16.2	£595	£714.00
ZAE-150-040/IF	1629	400	white	500	17.9	£665	£798.00
ZAE-150-050/IF	1629	500	white	750	20.3	£680	£816.00
ZAE-180-060/IF	1893	600	white	1000	27.0	£787	£944.40
ZAE-180-080/IF	1893	800	white	1250	32.9	£860	£1,032.00

Note: Height includes the immersion heater. (See diagrams below)

*1/8" air vent
Width excludes air vent
F = flow
R = return
H = height
W = width
Tube: Horizontal \varnothing 38x10.5
Tube: Vertical \varnothing 38mm
All dimensions in mm

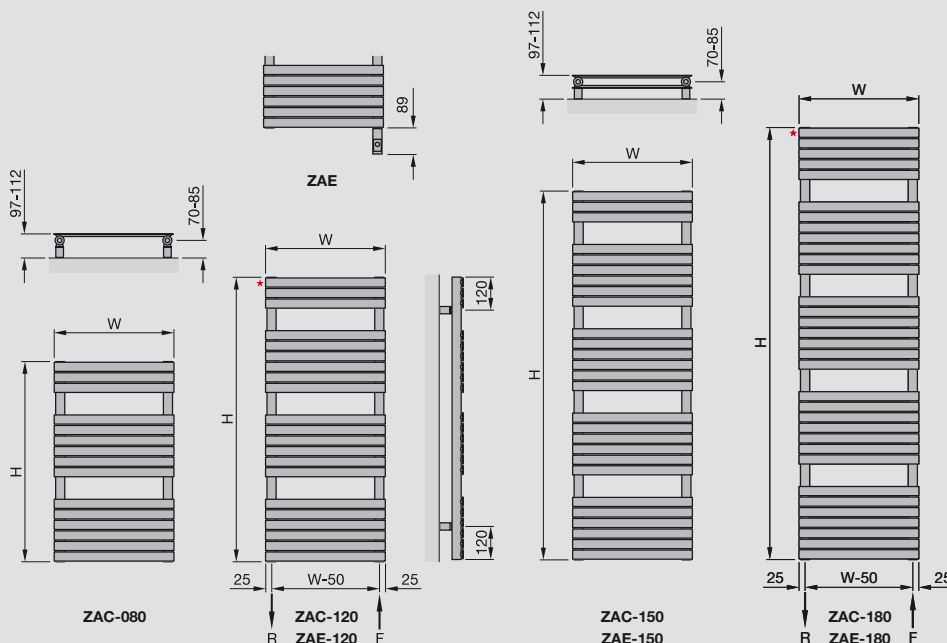

For full compliant technical specifications, refer to page 135
To make an approximate conversion from T=50K to T=60K multiply outputs by 1.2

Zehnder Roda Spa



High output and practicality in a contemporary design, the Zehnder Roda Spa is particularly suitable for modern bathrooms with angular sanitaryware.



Roda Spa



Valves: see page 122



Safir Infra-red electric immersion heater control unit see page 129



Anthracite



Central Heating Model STOCK listed in black	Height mm	Width mm	Finish	Output $\Delta T=50K$ Watts/btu All outputs certified to EN 442	Electric Immersion Rating Watts	Weight kg	RRP (ex VAT)	RRP (inc 20% VAT)
Zehnder Roda Spa								
RO-060-100	667	1000	white	656/2238	400	14.6	£408	£489.60
RO-070-050	741	500	white	377/1286	200	8.2	£296	£355.20
RO-100-050	1037	500	white	504/1720	300	12.2	£351	£421.20
RO-120-050	1259	500	white	583/1989	400	14.0	£388	£465.60
RO-150-050	1481	500	white	691/2358	500	16.5	£468	£561.60
RO-180-050	1851	500	white	817/2788	500	21.5	£569	£682.80
RO-180-060	1851	600	white	980/3344	600	23.5	£593	£711.60
RO-180-080	1851	800	white	1307/4460	900	31.5	£724	£868.80
RO-070-050-0346	741	500	anthracite	377/1286	200	8.2	£370	£444.00
RO-120-050-0346	1259	500	anthracite	583/1989	400	14.0	£485	£582.00
RO-150-050-0346	1481	500	anthracite	691/2358	500	16.5	£585	£702.00

Dual Energy: Self Fit - Additional cost to Central Heating model prices see page 128 for details

Electric Heating Model	Height mm	Width mm	Finish	Electric Immersion Rating Watts with Safir Class II, IPX4 Zone 1 bath, Zone 2 shower	Weight kg	RRP (ex VAT)	RRP (inc 20% VAT)
Zehnder Roda Spa Electric							
ROE-090-050/IF	815	500	white	500	15.1	£481	£577.20
ROE-150-050/IF	1333	500	white	750	22.3	£597	£716.40
ROE-180-050/IF	1629	500	white	1000	27.5	£655	£786.00
ROE-200-060/IF	1851	600	white	1250	34.7	£718	£861.60
ROE-200-080/IF	1851	800	white	1500	44.7	£803	£963.60

Colour finish: Standard colours from the Zehnder colour chart including matt white finish: white RAL 9016 + 25%. Colour finish and non-stock products delivery: 20-30 working days.

*1/8" air vent
Width excludes air vent
F = flow
R = return
H = height
W = width
Tube: Dimensions: 70mm x 11mm
Tube: Vertical \varnothing 38mm
All dimensions in mm

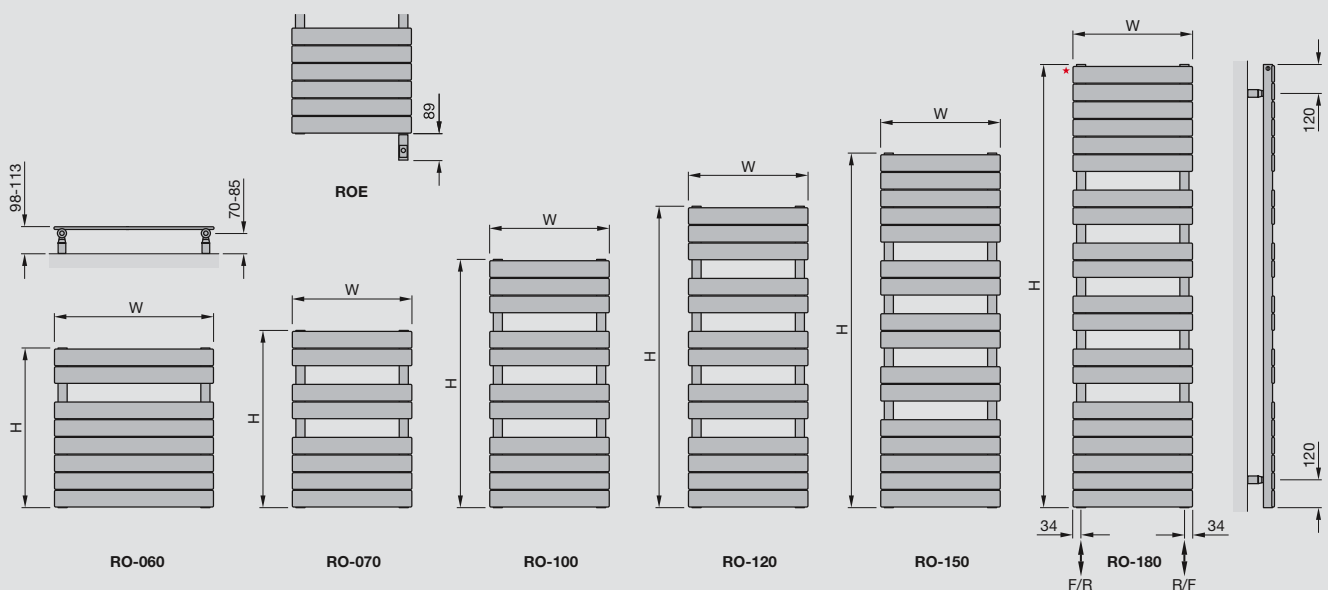

For full **CE** compliant technical specifications, refer to page 135
To make an approximate conversion from T=50K to T=60K multiply outputs by 1.2

Zehnder Roda Spa Asym



A highly functional and stylish towel rail with a practical asymmetrical design which allows easy access for hanging of towels. The Zehnder Roda Spa Asym central heating model is available with the horizontal tubes facing left or right.



Brown Quartz



Beige Quartz



Volcanic



Valves: see page 122



Strawberry

Central Heating Model STOCK listed in black	Height mm	Width mm	Finish	Output $\Delta T=50K$ Watts/btu All outputs certified to EN 442	Electric Immersion Rating Watts	Weight kg	RRP (ex VAT)	RRP (inc 20% VAT)
Zehnder Roda Spa Asym								
ROFL-080-055	805	550	white	429/1464	300	10	£313	£375.60
ROFL-120-055	1183	550	white	594/2027	400	14	£388	£465.60
ROFL-170-055	1676	550	white	809/2760	500	20	£520	£624.00
ROFR-080-055	805	550	white	429/1464	300	10	£313	£375.60
ROFR-120-055	1183	550	white	594/2027	400	14	£388	£465.60
ROFR-170-055	1676	550	white	809/2760	500	20	£520	£624.00
ROFL-080-055-0336	805	550	volcanic	429/1464	300	10	£391	£469.20
ROFL-120-055-0336	1183	550	volcanic	594/2027	400	14	£485	£582.00
ROFL-170-055-0336	1676	550	volcanic	809/2760	500	20	£650	£780.00
ROFR-080-055-0336	805	550	volcanic	429/1464	300	10	£391	£469.20
ROFR-120-055-0336	1183	550	volcanic	594/2027	400	14	£485	£582.00
ROFR-170-055-0336	1676	550	volcanic	809/2760	500	20	£650	£780.00
ROFL-080-055-0523	805	550	beige quartz	429/1464	300	10	£391	£469.20
ROFL-120-055-0523	1183	550	beige quartz	594/2027	400	14	£485	£582.00
ROFL-170-055-0523	1676	550	beige quartz	809/2760	500	20	£650	£780.00
ROFR-080-055-0523	805	550	beige quartz	429/1464	300	10	£391	£469.20
ROFR-120-055-0523	1183	550	beige quartz	594/2027	400	14	£485	£582.00
ROFR-170-055-0523	1676	550	beige quartz	809/2760	500	20	£650	£780.00
ROFL-080-055-0529	805	550	brown quartz	429/1464	300	10	£391	£469.20
ROFL-120-055-0529	1183	550	brown quartz	594/2027	400	14	£485	£582.00
ROFL-170-055-0529	1676	550	brown quartz	809/2760	500	20	£650	£780.00
ROFR-080-055-0529	805	550	brown quartz	429/1464	300	10	£391	£469.20
ROFR-120-055-0529	1183	550	brown quartz	594/2027	400	14	£485	£582.00
ROFR-170-055-0529	1676	550	brown quartz	809/2760	500	20	£650	£780.00

Dual Energy: Self Fit - Additional cost to Central Heating model prices see page 128 for details

Colour finish: Standard colours from the Zehnder colour chart including matt white finish: white RAL 9016 + 25%. Colour finish and non-stock products delivery: 20-30 working days.

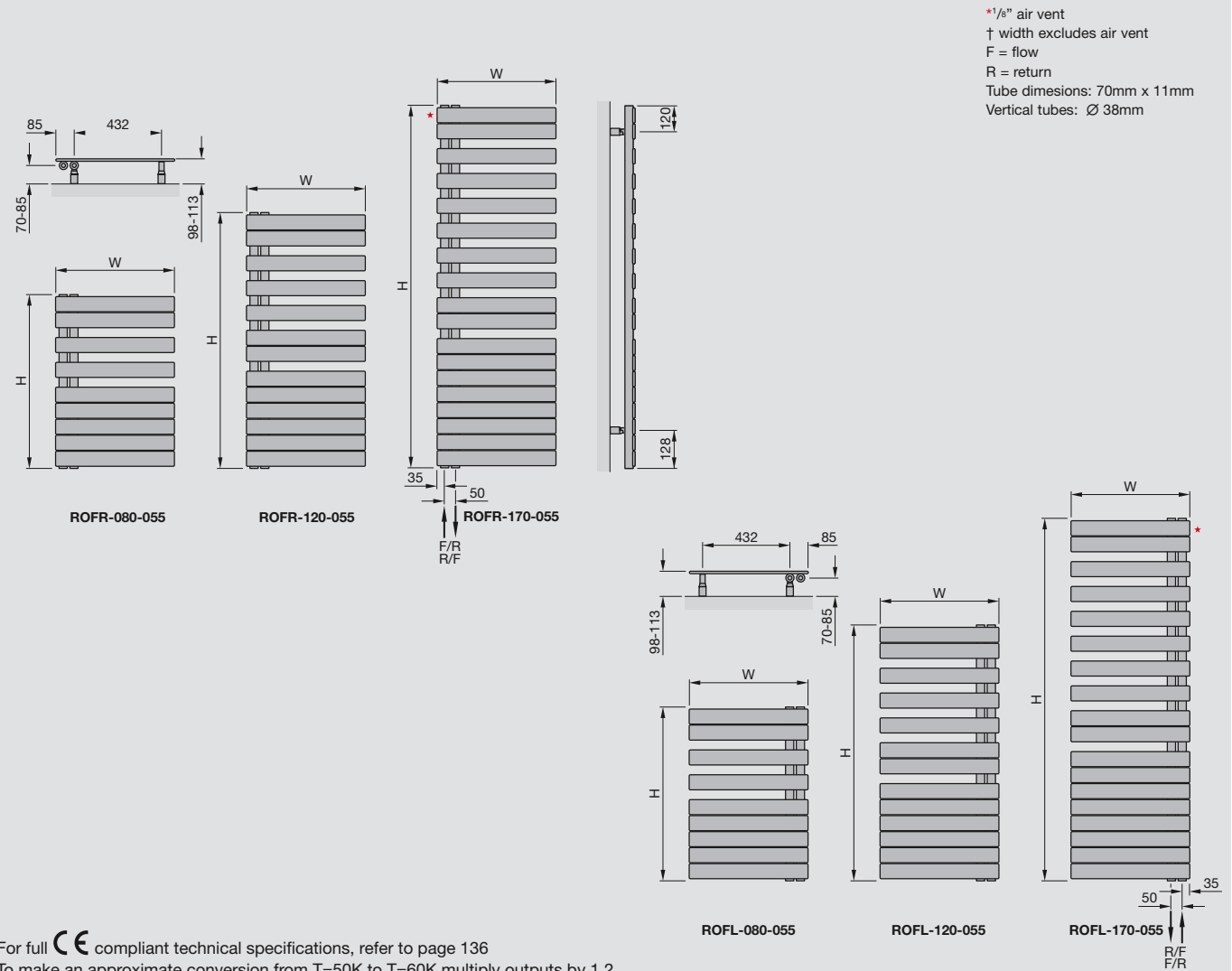

For full compliant technical specifications, refer to page 136
 To make an approximate conversion from T=50K to T=60K multiply outputs by 1.2

Zehnder Roda Spa Asym



The Roda Spa Asym with its easy to operate memoprogrammer immersion heater is a favourite for its overall functionality.



See page 129 for further information.



Electric Heating Model STOCK listed in black	Height mm	Width mm	Finish	Electric Immersion Rating (Watts) with factory fitted Memoprogram immersion Class II, IPX4, IK09, Zone 1 bath, Zone 2 shower	Weight kg	RRP (ex VAT)	RRP (inc 20% VAT)
⚡ Zehnder Roda Spa Asym Electric							
ROFEL-080-55/TF	85	550	white	500	15	£391	£469.20
ROFEL-120-55/TF	125	550	white	750	21	£491	£589.20
ROFEL-170-55/TF	1723	550	white	1000	29	£586	£703.20

Opposite handed model, fitted with an infra-red controlled immersion heater available. Details and prices on application.

🎨 **Colour finish:** Standard colours from the Zehnder colour chart including matt white finish: white RAL 9016 + 25%. Colour finish and non-stock products delivery: 20-30 working days.

H = height
W = width
Tube: Dimensions: 70mm x 11mm
Tube: Vertical tubes: Ø 38mm
All dimensions in mm

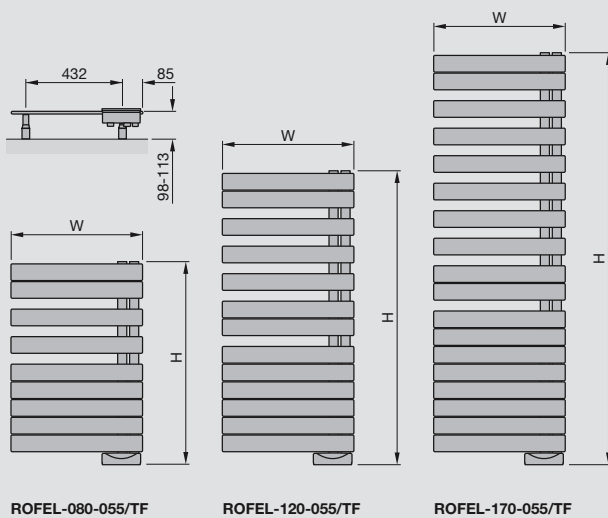

ROFEL-080-055/TF

ROFEL-120-055/TF

ROFEL-170-055/TF

Zehnder Charleston Bar



The popular multi-column with the chrome towel bar combines warmth and practicality.



Volcanic



Valves: see page 122



Lambswool brush



Central Heating Model STOCK listed in black	Height mm	Width mm	No. of sections	Finish	Output $\Delta T=50K$ Watts/btu All outputs certified to EN 442	Centre from wall	Overall projection	Weight kg	RRP (ex VAT)	RRP (inc 20% VAT)
Zehnder Charleston Bar (Cloakroom size - see pages 10/11)										
2075-6	742	306	6	white	330/1128	59	134	7.2	£234	£280.80
2075-6-0336	742	306	6	volcanic	330/1128	59	134	7.2	£261	£313.20
Zehnder Charleston Bar										
2090-9	900	444	9	white	575/1961	59	134	12.6	£313	£375.60
2120-9	1200	444	9	white	744/2358	59	134	17.1	£382	£458.40
2150-9	1500	444	9	white	936/3198	59	134	20.7	£428	£513.60
2180-9	1800	444	9	white	1116/3807	59	134	24.3	£460	£552.00
2090-9-0336	900	444	9	volcanic	575/1961	59	134	12.6	£360	£432.00
2120-9-0336	1200	444	9	volcanic	744/2358	59	134	17.1	£446	£535.20
2150-9-0336	1500	444	9	volcanic	936/3198	59	134	20.7	£504	£604.80
2180-9-0336	1800	444	9	volcanic	1116/3807	59	134	24.3	£544	£652.80

1 x 368mm chrome towel bar included. Projection including towel bar: 134mm

Accessories			
Model		RRP (ex VAT)	RRP (inc 20% VAT)
601020	Lambs wool brush	£49	£58.80
966018	Additional 368mm Towel Bar	£125	£150.00

The additional chrome bar can be cut down to fit if required

Colour finish: Standard colours from the Zehnder colour chart including matt white finish: white RAL 9016 + 25%. Colour finish and non-stock products delivery: 20-30 working days.

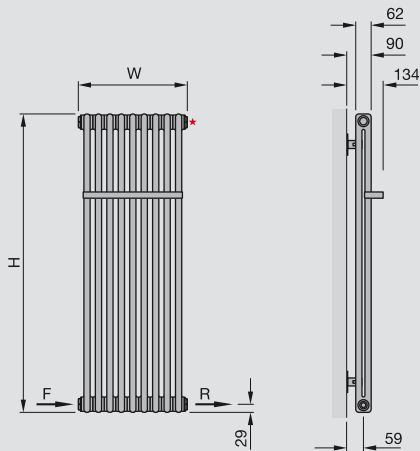

*1/2" air vent
Width excludes air vent
F = flow
R = return
H = height
W = width
Tube: \varnothing 25mm
All dimensions in mm

For full compliant technical specifications, refer to page 136
To make an approximate conversion from T=50K to T=60K multiply outputs by 1.2

Zehnder Nobis



Elegant patented chrome towel drying radiator with unique contemporary joints. The Nobis is also suitable for installation on hot water systems.



Valves: see page 122



Central Heating Model STOCK listed in black	Height mm	Width mm	Finish	Output $\Delta T=50K$ Watts/btu All outputs certified to EN 442	Electric Immersion Rating Watts	Weight kg	RRP (ex VAT)	RRP (inc 20% VAT)
 Zehnder Nobis								
NOB-100-050	965	500	chrome	210/717	n/a	9.0	£798	£957.60
NOB-150-050	1520	chrome	325/1109	n/a	14.0	£979	£1,174.80	

*1/2" air vent (rear)
F = flow
R = return
H = height
W = width
Tube: \varnothing 25mm
All dimensions in mm

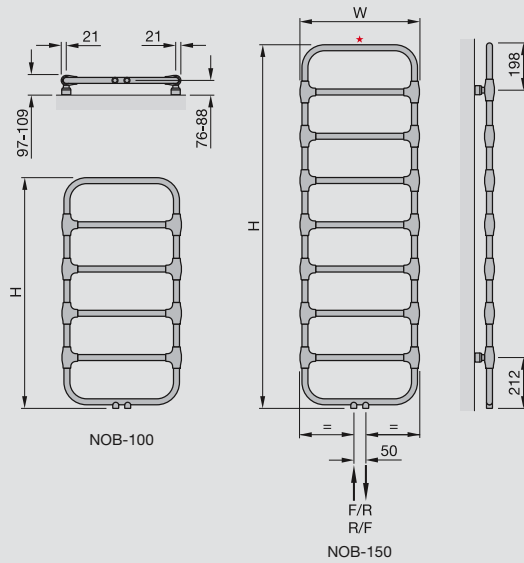

Traditional Range



Distinguished luxury available in chrome or antique gold, for central heating, domestic hot water, dual energy or electric only installations.



RAL 6034



Valves: see page 122



Traditional range Model STOCK listed in black	Code	Height mm	Width mm	Finish	Output $\Delta T=50K$ Watts/BTU All outputs certified to EN 442	Electric Immersion Rating Watts	RRP (ex VAT)	RRP (inc 20% VAT)
🔥 Central heating only models (the Zehnder Balmoral is not suitable for domestic hot water systems)								
Zehnder Balmoral	BALM CPHO	850	735	chrome	683/2330	400	£1,070	£1,284.00
	BALM AGHO			antique gold	683/2330		£1,298	£1,557.60
🔥🔌 Central heating and domestic hot water models								
Zehnder Osbourne	OSBO CPHO	850	600	chrome	246/839	150	£590	£708.00
	OSBO AGHO			antique gold	246/839		£723	£867.60
Zehnder Buckingham	BUCK CPHO	750	500	chrome	175/597	150	£590	£708.00
	BUCK AGHO			antique gold	175/597		£723	£867.60
🔌 Dual energy models (IPX5, Zone 1) with factory fitted immersion								
Zehnder Buckingham	BUCK CPDE	750	500	chrome	175/597	150	£832	£998.40
	BUCK AGDE			antique gold	175/597		£978	£1,173.60
⚡ Electric only models (IPX5, Zone 1) Immersion heater (no controls) on right-hand side as standard								
Zehnder Balmoral	BALM CPEO	850	735	chrome	n/a	400	£1,431	£1,717.20
	BALM AGEO			antique gold	n/a		£1,630	£1,956.00
Zehnder Osbourne	OSBO CPEO	850	600	chrome	n/a	150	£924	£1,108.80
	OSBO AGEO			antique gold	n/a		£1,035	£1,242.00
Zehnder Buckingham	BUCK CPEO	750	500	chrome	n/a	150	£916	£1,099.20
	BUCK AGEO			antique gold	n/a		£1,035	£1,242.00

🎨 Colour finish for Zehnder Balmoral column radiator: Only available in RAL colours: List price of central heating model +25%.

Alternative Finish Options

Colour finish and non-stock products delivery: 20-30 working days

Mixage finish (chrome rails with antique gold ball joints): List price of chrome models + 25%

Nickel finish: List price of chrome models + 25%

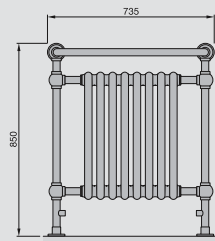

BALM
Zehnder Balmoral

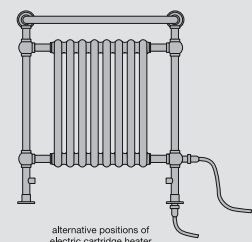
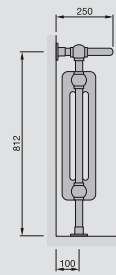
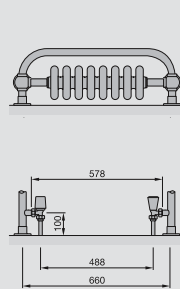

alternative positions of electric cartridge heater when specified



Zehnder Osbourne

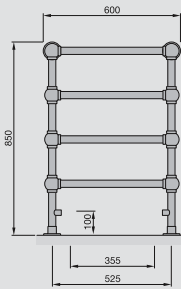

OSBO

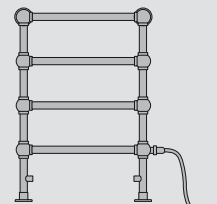
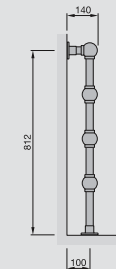

position of electric cartridge heater when fitted



Zehnder Buckingham

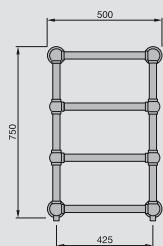

BUCK

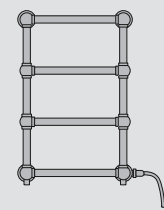
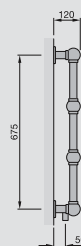

position of electric cartridge heater when fitted

All dimensions in mm

For full **CE** compliant technical specifications, refer to page 136-137

To make an approximate conversion from T=50K to T=60K multiply outputs by 1.2

Stainless steel heated towel rails and radiators

Heat at its most versatile.

The versatility of stainless steel radiators is a well established fact. Suitable for installation on a central heating or domestic hot water system, and whether highly polished, brushed or with a painted finish, its high resistance to corrosion and 10 year warranty is a notable benefit. The range of aesthetic designs suitable for bathrooms, wet rooms, kitchens or room radiators offers a complete choice to the home owner.





Zehnder Quaro Spa





The new Zehnder Quaro Spa has an elegant square profile frame and horizontal heating pipes. Beautifully designed with clarity and simplicity, even the right-angled wall brackets look cool! Generously spaced tubes give plenty of room for warming fluffy towels. Available in both central heating and electric versions, this gorgeous stainless steel towel radiator is the ideal solution for contemporary wet rooms.





Valves: see page 122

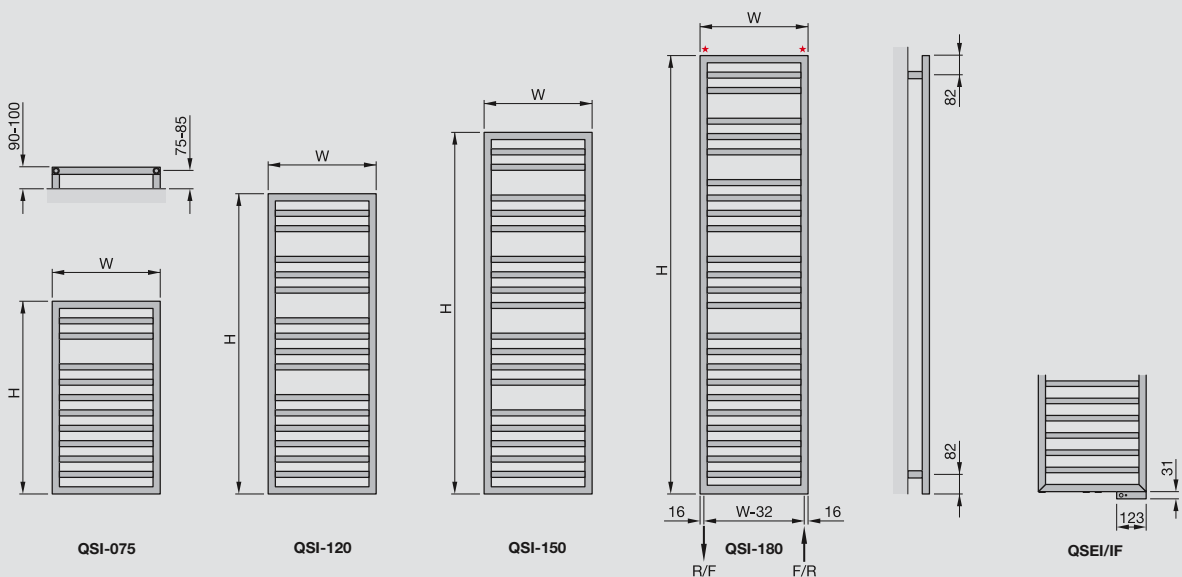

Central Heating Model STOCK listed in black	Height mm	Width mm	Finish	Output $\Delta T=50K$ Watts/Btu All outputs certified to EN 442	Weight kg	RRP (ex VAT)	RRP (inc 20% VAT)
  Zehnder Quaro Spa Stainless Steel							
QSI-075-045	803	450	stainless steel	222 /757	7.1	£410	£492.00
QSI-120-045	1251	450	stainless steel	330 /1126	9.8	£527	£632.40
QSI-120-055	1251	550	stainless steel	388 /1324	11.6	£594	£712.80
QSI-150-045	1507	450	stainless steel	393 /1341	11.3	£646	£775.20
QSI-150-055	1507	550	stainless steel	464 /1583	13.4	£698	£837.60
QSI-180-055	1827	550	stainless steel	569 /1941	16.1	£782	£938.40

Electric Heating Model	Height mm	Width mm	Finish	Electric Immersion Rating Watts with Safir Class II, IPX4 Zone 1 bath, Zone 2 shower	Weight kg	RRP (ex VAT)	RRP (inc 20% VAT)
 Zehnder Quaro Spa Electric Stainless Steel							
QSEI-120-045/IF	1281	450	stainless steel	300	14.9	£777	£932.40
QSEI-120-055/IF	1281	550	stainless steel	300	17.4	£844	£1,012.80
QSEI-150-045/IF	1537	450	stainless steel	300	17.3	£896	£1,075.20
QSEI-150-055/IF	1537	550	stainless steel	300	20.2	£948	£1,137.60
QSEI-180-055/IF	1857	550	stainless steel	500	24.3	£1,032	£1,238.40



For full  compliant technical specifications, refer to page 137
To make an approximate conversion from T=50K to T=60K multiply outputs by 1.2

Zehnder Stellar



Simple, elegant and contemporary, the stainless steel Stellar is the ideal solution for minimalist bathroom designs.



Valves: see page 122



Bracket detail



Stainless Steel STOCK listed in black	Height mm	Width mm	Finish	Output $\Delta T=50K$ Watts/btu All outputs certified to EN 442	Electric Immersion Rating Watts	Weight kg	RRP (ex VAT)	RRP (inc 20% VAT)
Zehnder Stellar Stainless Steel								
STNI-060-045	572	450	s/steel polished	159/541	100	3.3	£225	£270.00
STNI-060-100	572	1000	s/steel polished	284/970	200	5.8	£472	£566.40
STNI-080-030	788	300	s/steel polished	159/541	100	3.6	£223	£267.60
STNI-080-045	788	450	s/steel polished	206/702	150	4.5	£295	£354.00
STNI-080-060	788	600	s/steel polished	253/863	150	5.4	£366	£439.20
STNI-120-030	1220	300	s/steel polished	242/826	150	5.5	£320	£384.00
STNI-120-045	1220	450	s/steel polished	316/1078	150	6.9	£438	£525.60
STNI-120-060	1220	600	s/steel polished	391/1334	200	8.4	£564	£676.80
STNI-150-045	1508	450	s/steel polished	389/1327	300	8.5	£552	£662.40
STNI-150-060	1508	600	s/steel polished	491/1675	300	10.2	£711	£853.20
STNI-170-045	1724	450	s/steel polished	452/1542	300	10.0	£665	£798.00
STNI-170-060	1724	600	s/steel polished	545/1860	400	12.0	£857	£1,028.40
STNI-060-045-CF	572	450	s/steel painted	233/795	100	3.3	£225	£270.00
STNI-060-100-CF	572	1000	s/steel painted	430/1467	200	5.8	£472	£566.40
STNI-080-030-CF	788	300	s/steel painted	232/792	100	3.6	£223	£267.60
STNI-080-045-CF	788	450	s/steel painted	317/1082	150	4.5	£295	£354.00
STNI-080-060-CF	788	600	s/steel painted	395/1348	150	5.4	£366	£439.20
STNI-120-030-CF	1220	300	s/steel painted	353/1204	150	5.5	£320	£384.00
STNI-120-045-CF	1220	450	s/steel painted	482/1645	150	6.9	£438	£525.60
STNI-120-060-CF	1220	600	s/steel painted	600/2047	200	8.4	£564	£676.80
STNI-150-045-CF	1508	450	s/steel painted	591/2016	300	8.5	£552	£662.40
STNI-150-060-CF	1508	600	s/steel painted	736/2511	300	10.2	£711	£853.20
STNI-170-045-CF	1724	450	s/steel painted	672/2293	300	10.0	£665	£798.00
STNI-170-060-CF	1724	600	s/steel painted	838/2859	400	12.0	£857	£1,028.40

Dual Energy: Self Fit - Additional cost to Central Heating model prices see page 128 for details

Colour finish: Standard colours from the Zehnder colour chart. Delivery of colour finish and non-stock products: 20-30 working days.

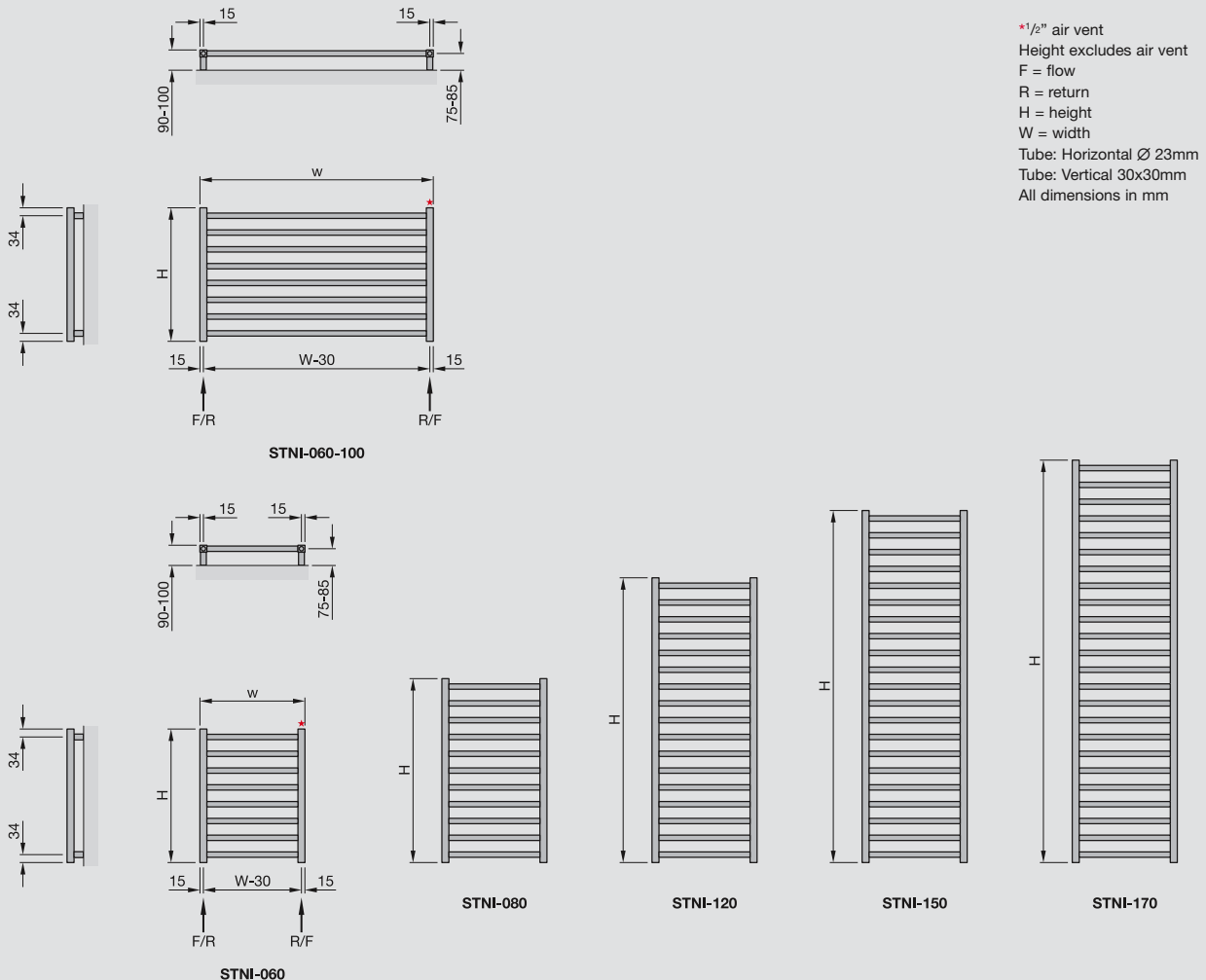

For full compliant technical specifications, refer to page 137
To make an approximate conversion from T=50K to T=60K multiply outputs by 1.2

Zehnder Stellar Spa



Contemporary in design in stainless steel to suit the latest lifestyle trends. Suitable for dual energy installation for year-long comfort.





Valves: see page 122

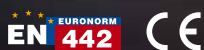

Bracket detail



Stainless Steel STOCK listed in black	Height mm	Width mm	Finish	Output $\Delta T=50K$ Watts/btu All outputs certified to EN 442	Electric Immersion Rating Watts	Weight kg	RRP (ex VAT)	RRP (inc 20% VAT)
 Zehnder Stellar Spa Stainless Steel								
STGI-060-045	572	450	s/steel polished	161/549	100	3.1	£203	£243.60
STGI-060-100	572	1000	s/steel polished	272/928	150	5.3	£427	£512.40
STGI-080-030	788	300	s/steel polished	171/583	100	3.4	£202	£242.40
STGI-080-045	788	450	s/steel polished	220/751	100	4.2	£269	£322.80
STGI-080-060	788	600	s/steel polished	243/829	150	5.0	£333	£399.60
STGI-120-030	1220	300	s/steel polished	240/819	150	5.2	£290	£348.00
STGI-120-045	1220	450	s/steel polished	309/1054	150	6.5	£396	£475.20
STGI-120-060	1220	600	s/steel polished	379/1293	200	7.7	£511	£613.20
STGI-150-045	1508	450	s/steel polished	361/1232	300	7.8	£500	£600.00
STGI-150-060	1508	600	s/steel polished	448/1529	300	9.3	£643	£771.60
STGI-170-045	1724	450	s/steel polished	434/1481	200	9.4	£603	£723.60
STGI-170-060	1724	600	s/steel polished	517/1764	300	11.2	£776	£931.20
STGI-060-045-CF	572	450	s/steel painted	219/747	100	3.1	£203	£243.60
STGI-060-100-CF	572	1000	s/steel painted	394/1344	150	5.3	£427	£512.40
STGI-080-030-CF	788	300	s/steel painted	218/744	100	3.4	£202	£242.40
STGI-080-045-CF	788	450	s/steel painted	294/1003	100	4.2	£269	£322.80
STGI-080-060-CF	788	600	s/steel painted	363/1239	150	5.0	£333	£399.60
STGI-120-030-CF	1220	300	s/steel painted	332/1133	150	5.2	£290	£348.00
STGI-120-045-CF	1220	450	s/steel painted	448/1529	150	6.5	£396	£475.20
STGI-120-060-CF	1220	600	s/steel painted	554/1890	200	7.7	£511	£613.20
STGI-150-045-CF	1508	450	s/steel painted	556/1897	300	7.8	£500	£600.00
STGI-150-060-CF	1508	600	s/steel painted	687/2344	300	9.3	£643	£771.60
STGI-170-045-CF	1724	450	s/steel painted	640/2184	200	9.4	£603	£723.60
STGI-170-060-CF	1724	600	s/steel painted	791/2699	300	11.2	£776	£931.20

 Dual Energy: Self Fit - Additional cost to Central Heating model prices see page 128 for details

 Colour finish: Standard colours from the Zehnder colour chart. Delivery of colour finish and non-stock products: 20-30 working days.

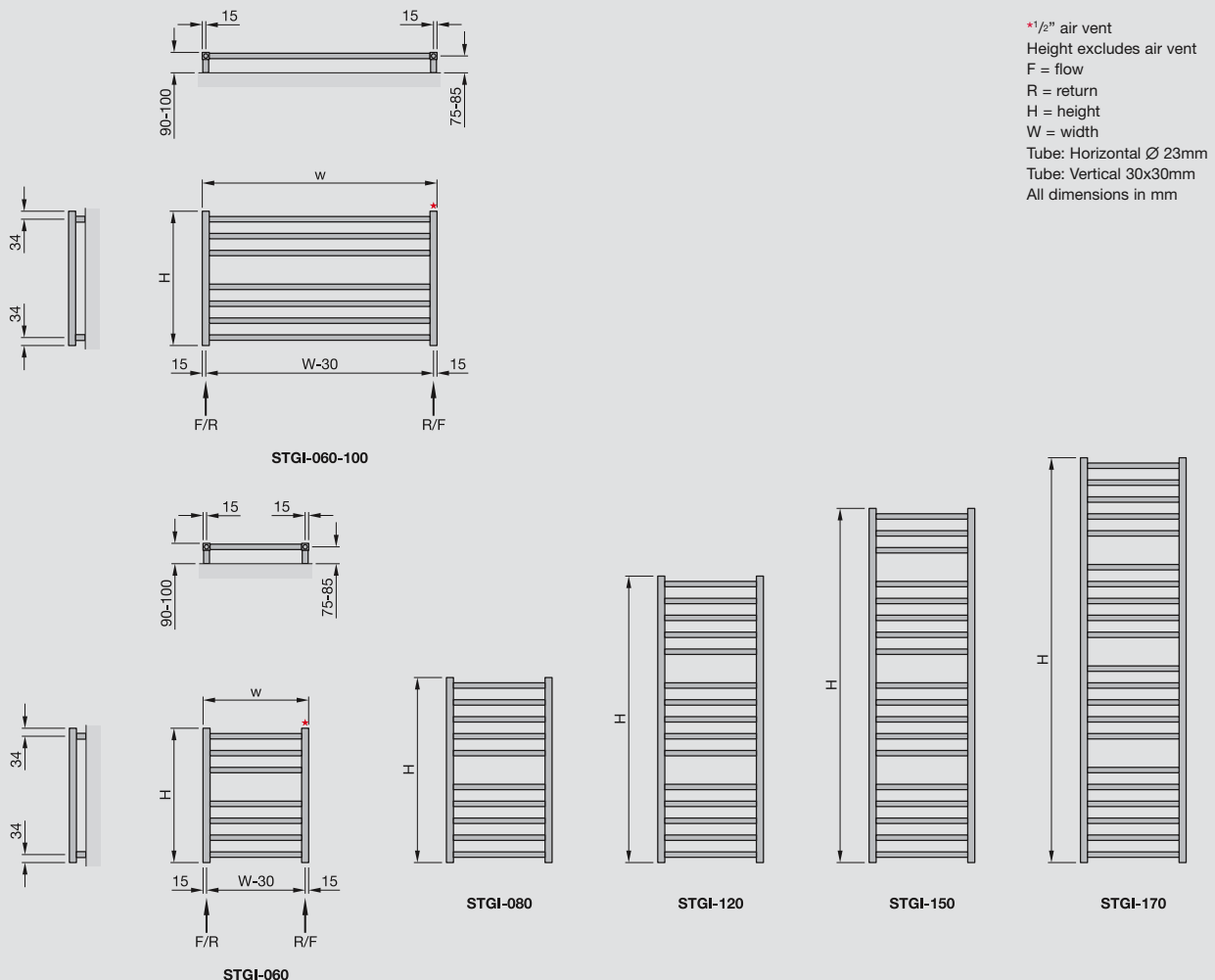

For full  compliant technical specifications, refer to page 138
To make an approximate conversion from T=50K to T=60K multiply outputs by 1.2

Zehnder Subway



With its classic lines and broad appeal, the stainless steel Zehnder Subway towel rail offers versatility comfort and superb design.



Valves: see page 122



Stainless Steel Model STOCK listed in black	Height mm	Width mm	Finish	Output $\Delta T=50K$ Watts/btu All outputs certified to EN 442	Electric Immersion Rating Watts	Weight kg	RRP (ex VAT)	RRP (inc 20% VAT)
Zehnder Subway Stainless Steel (brushed)								
SUBI-060-045	613	450	stainless steel	221/754	150	5.1	£392	£470.40
SUBI-130-045	1261	450	stainless steel	370/1262	200	8.7	£549	£658.80
SUBI-130-060	1261	600	stainless steel	447/1525	300	10.4	£609	£730.80
SUBI-150-045	1549	450	stainless steel	445/1518	300	10.4	£646	£775.20
SUBI-150-060	1549	600	stainless steel	538/1836	300	12.4	£719	£862.80
SUBI-180-060	1837	600	stainless steel	633/2160	400	14.4	£805	£966.00

Dual Energy: Self Fit - Additional cost to Central Heating model prices. See page 128 for details

Height mm	Width mm	Finish	Weight kg	Simple electric immersion heater Class II IPX4, Zones 1 and 2				Electric immersion heater with Safir Class II IPX4, Zones 1 and 2			
				Model	Electric rating	RRP (ex VAT)	RRP (inc 20% VAT)	Model	Electric rating	RRP (ex VAT)	RRP (inc 20% VAT)
Zehnder Subway electric only models (with a choice of either a simple immersion heater (no controls) or the Safir immersion heater)											
1261	450	s/steel	13.2	SUBEI-130-045/F	300	£637	£764.40	SUBEI-130-045/IF	300	£894	£1,072.80
1549	450	s/steel	15.9	SUBEI-150-045/F	300	£746	£895.20	SUBEI-150-045/IF	300	£1,058	£1,269.60
1549	600	s/steel	19.6	SUBEI-150-060/F	500	£825	£990.00	SUBEI-150-060/IF	500	£1,190	£1,428.00
1837	600	s/steel	21.8	SUBEI-180-060/F	600	£919	£1,102.80	SUBEI-180-060/IF	600	£1,304	£1,564.80

Simple Electric Immersion heating has Safir casing without infra red control included.

Note: Height does not include the immersion heater. (See diagrams below)

Optional wall brackets: Increases space behind rail by 20mm

Model		RRP (ex VAT)	RRP (inc 20% VAT)
952119	Subway SUB extended bracket kit. Painted finish	£37	£44.40

All brackets for stainless steel radiators are supplied with an Inox painted stainless steel finish.

Delivery of non-stock products: 20-30 working days.

*1/2" air vent
Height excludes air vent
F = flow
R = return
H = height
W = width
Tube: Horizontal \varnothing 23mm
Tube: Vertical 30x30mm
All dimensions in mm

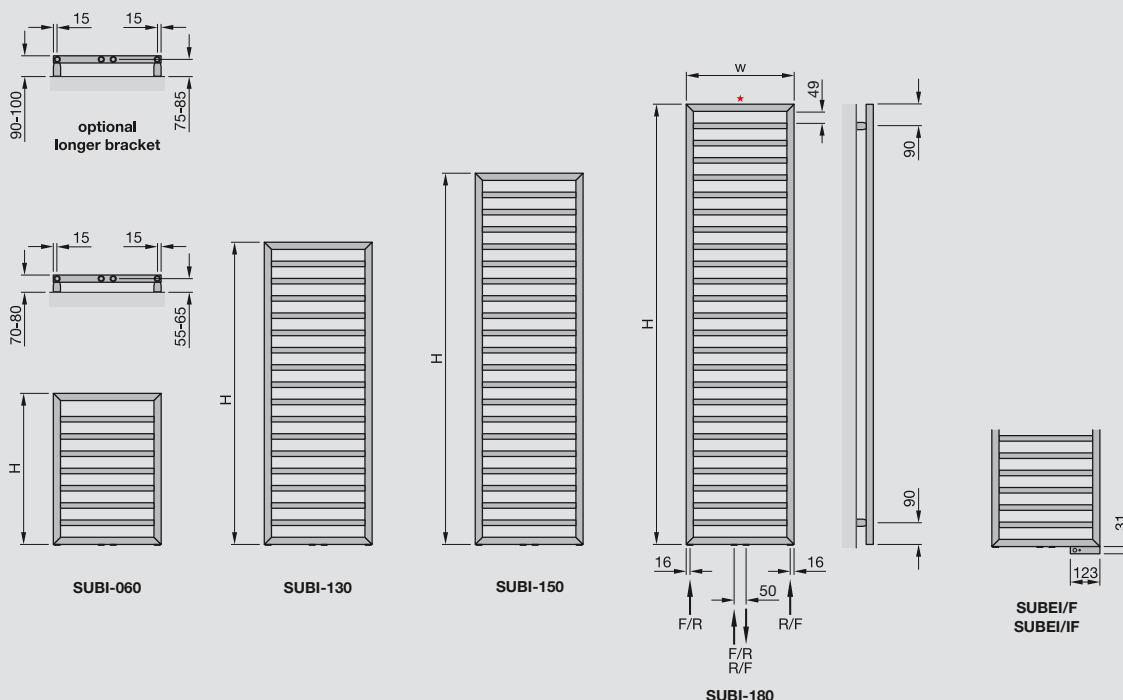

For full compliant technical specifications, refer to page 138
To make an approximate conversion from T=50K to T=60K multiply outputs by 1.2

Zehnder Cove



Distinctive elegance combining brushed stainless steel with perfectly proportioned polished steel sections to enhance any bathroom design. 10 year warranty.



Valves: see page 122



Stainless Steel STOCK listed in black	Height mm	Width mm	Finish	Output $\Delta T=50K$ Watts/btu All outputs certified to EN 442	Electric Immersion Rating Watts	Weight kg	RRP (ex VAT)	RRP (inc 20% VAT)
Zehnder Cove Stainless Steel								
COVE-120-050	1180	500	stainless steel	304/1037	200	10.3	£769	£922.80
COVE-120-060	1180	600	stainless steel	351/1198	200	12.0	£796	£955.20
COVE-140-050	1360	500	stainless steel	345/1177	200	11.6	£1,075	£1,290.00
COVE-140-060	1360	600	stainless steel	402/1372	200	13.6	£1,104	£1,324.80

Dual Energy: Self Fit - Additional cost to Central Heating model prices see page 128 for details

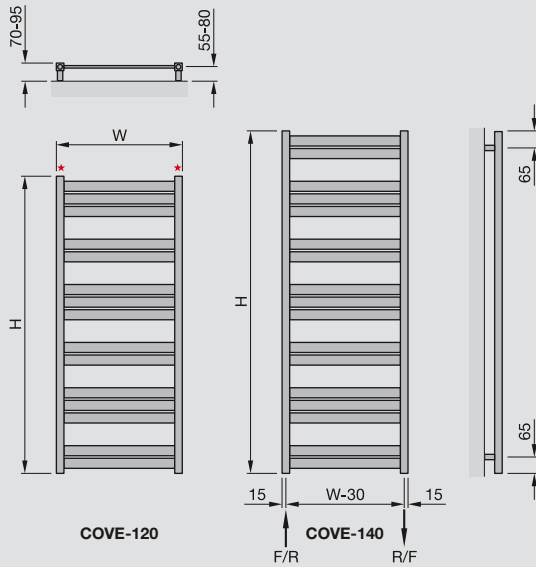

*1/2" air vent
 Height excludes air vent
 F = flow
 R = return
 H = height
 W = width
 Tube: Horizontal 30x15mm
 Tube: Vertical 30x30mm
 All dimensions in mm

For full compliant technical specifications, refer to page 138
 To make an approximate conversion from T=50K to T=60K multiply outputs by 1.2

Zehnder Keel Asym



Now available in both polished and brushed stainless steel, a stylishly practical radiator giving easy access for hanging towels, enhanced with a polished band of steel between the vertical tubes. 10 year warranty.



Valves: see page 122



Stainless Steel STOCK listed in black	Height mm	Width mm	Finish	Output $\Delta T=50K$ Watts/btu All outputs certified to EN 442	Electric Immersion Rating Watts	Weight kg	RRP (ex VAT)	RRP (inc 20% VAT)
Zehnder Keel Asym stainless steel								
KEA-120-050-9517	1190	500	s/steel brushed	307/1047	200	12.4	£709	£850.80
KEA-140-050-9517	1400	500	s/steel brushed	357/1218	200	14.5	£807	£968.40
KEA-120-050-9516	1190	500	s/steel polished	307/1047	200	12.4	£779	£934.80
KEA-140-050-9516	1400	500	s/steel polished	357/1218	200	14.5	£887	£1,064.40

Dual Energy: Self Fit - Additional cost to Central Heating model prices see page 128 for details

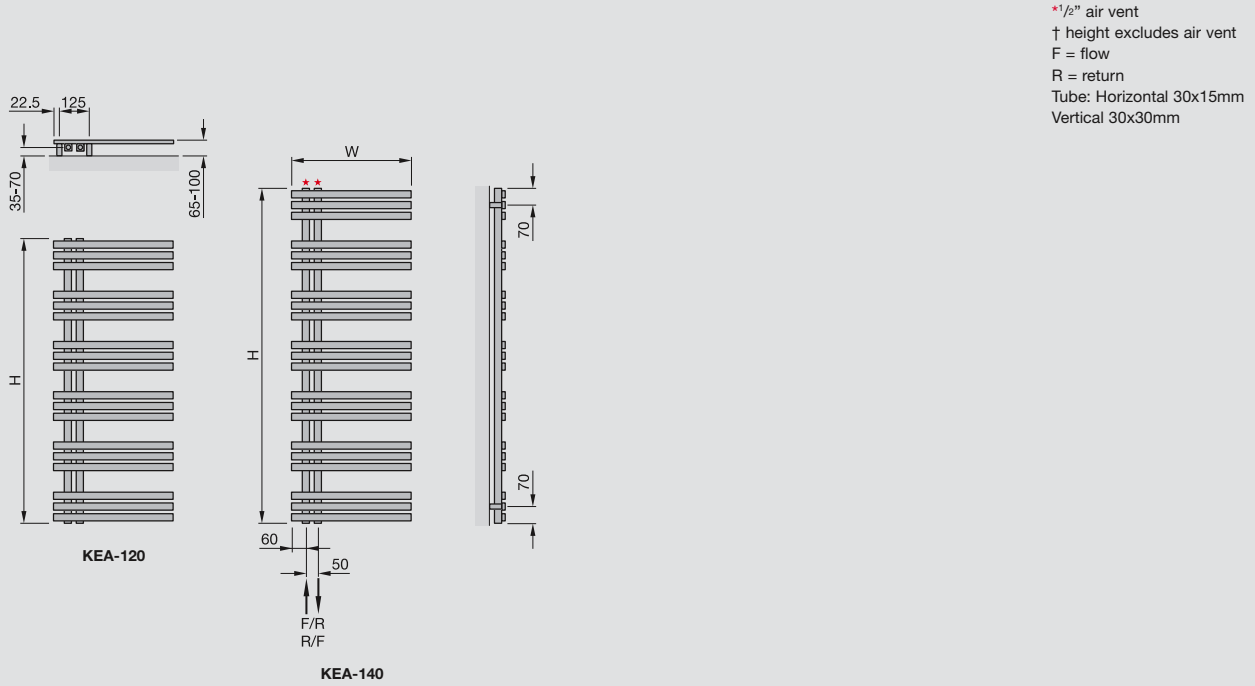

The Keel Asym can be installed with the horizontal tubes on the left or right hand side.

For full compliant technical specifications, refer to page 139
To make an approximate conversion from T=50K to T=60K multiply outputs by 1.2

Zehnder Keel Sym



Unique, polished stainless steel radiator finished with a highly polished centre piece to complement chrome bathroom fittings. 10 year warranty.



Valves: see page 122



Stainless Steel STOCK listed in black	Height mm	Width mm	Finish	Output $\Delta T=50K$ Watts/btu All outputs certified to EN 442	Electric Immersion Rating Watts	Weight kg	RRP (ex VAT)	RRP (inc 20% VAT)
Zehnder Keel Sym Stainless Steel								
KES-120-060-9516	1190	600	s/steel polished	254/867	150	10.3	£788	£945.60
KES-140-060-9516	1400	600	s/steel polished	299/1020	200	12.0	£897	£1,076.40

Dual Energy: Self Fit - Additional cost to Central Heating model prices see page 128 for details

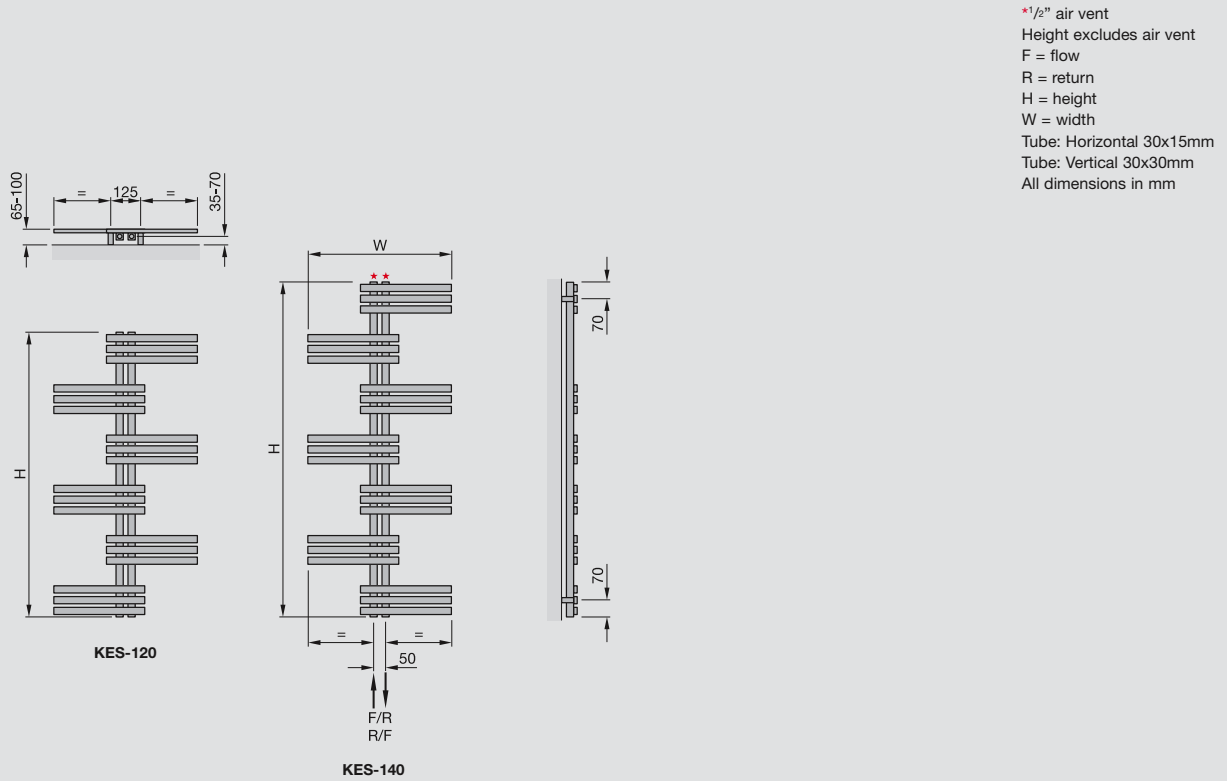

For full compliant technical specifications, refer to page 139
To make an approximate conversion from T=50K to T=60K multiply outputs by 1.2

Zehnder Bay



Stainless steel radiator with a brushed finish. Attractively proportioned with 8 connection possibilities for total flexibility, to suit any installation requirement. Includes option with convector fin (BAYF) for even greater heat output



Accessories: see page 71



Valves: see page 122



Towel bars: see page 71



Stainless Steel STOCK listed in black	Height mm	Width mm	Finish	Number of elements	Output $\Delta T=50K$ Watts/btu All outputs certified to EN 442	Weight kg	RRP (ex VAT)	RRP (inc 20% VAT)
Zehnder Bay Vertical stainless steel (brushed)								
BAY-100-053	1000	530	stainless steel	9	421/1436	15.3	£598	£717.60
BAY-120-047	1200	470	stainless steel	8	458/1563	16.0	£628	£753.60
BAY-120-053	1200	530	stainless steel	9	516/1761	18.0	£699	£838.80
BAY-150-029	1500	290	stainless steel	5	365/1245	12.5	£499	£598.80
BAY-170-029	1700	290	stainless steel	5	412/1406	14.0	£575	£690.00
BAY-170-047	1700	470	stainless steel	8	659/2249	22.4	£899	£1,078.80
BAY-170-053	1700	530	stainless steel	9	742/2532	25.2	£994	£1,192.80
BAYF-170-029	1700	290	stainless steel	5	520/1774	17.2	£649	£778.80
BAYF-170-047	1700	470	stainless steel	8	832/2839	30.4	£1,095	£1,314.00
BAYF-170-053	1700	530	stainless steel	9	936/3194	34.2	£1,223	£1,467.60

Stainless Steel STOCK listed in black	Height mm	Width mm	Finish	Number of elements	Output $\Delta T=50K$ Watts/btu All outputs certified to EN 442	Weight kg	RRP (ex VAT)	RRP (inc 20% VAT)
Zehnder Bay Horizontal stainless steel (brushed)								
BAY-100-053	530	1000	stainless steel	9	421/1436	15.3	£598	£717.60
BAY-120-047	470	1200	stainless steel	8	458/1563	16.0	£628	£753.60
BAY-120-053	530	1200	stainless steel	9	516/1761	18.0	£699	£838.80
BAY-150-029	290	1500	stainless steel	5	365/1245	12.5	£499	£598.80
BAY-170-029	290	1700	stainless steel	5	412/1406	14.0	£575	£690.00
BAY-170-047	470	1700	stainless steel	8	659/2249	22.4	£899	£1,078.80
BAY-170-053	530	1700	stainless steel	9	742/2532	25.2	£994	£1,192.80

Accessories

Model		RRP (ex VAT)	RRP (inc 20% VAT)
TPEG-0008	Bay Peg Chrome finish	£34	£40.80
TBAR-9517	Bay Towel Bar 290mm Brushed stainless steel finish	£71	£85.20
TBAR-9516	Bay Towel Bar 290mm Polished stainless steel finish	£97	£116.40

Bay Towel Bar not suitable for use with BAYF models.

*1/2" air vent
Height excludes air vent
F = flow
R = return
H = height
W = width
Tube: 30x50mm
All dimensions in mm

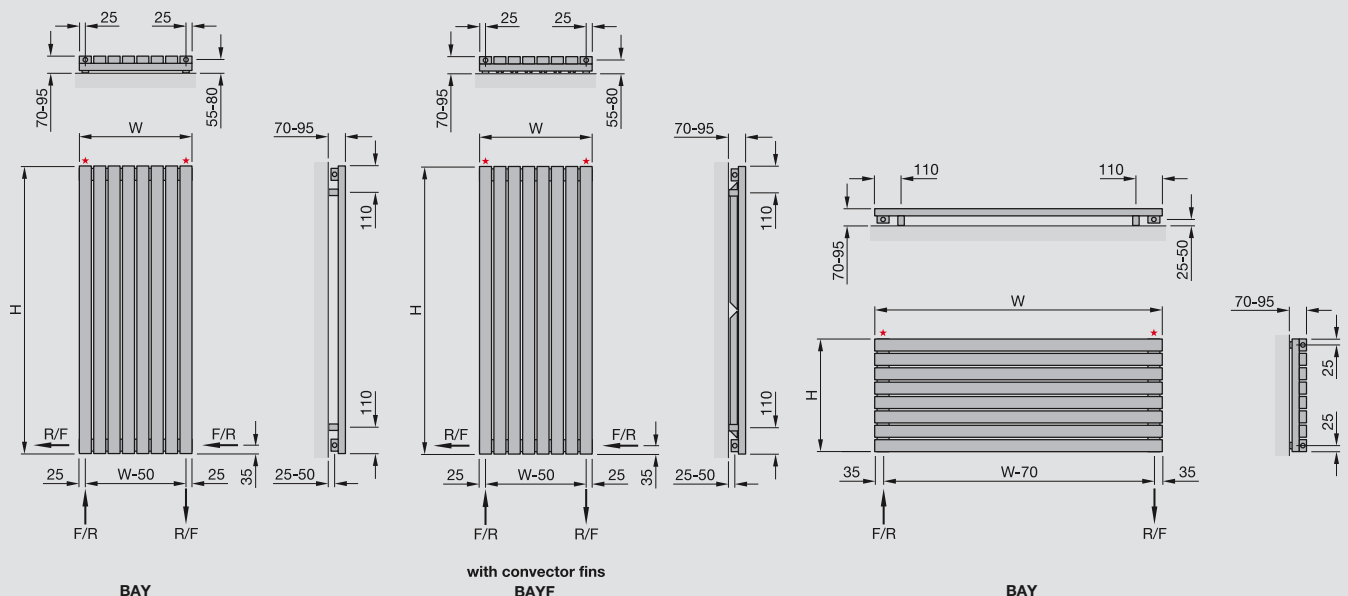

For full compliant technical specifications, refer to page 139
To make an approximate conversion from T=50K to T=60K multiply outputs by 1.2

General purpose radiators

Heating solutions for individuals.

Anyone furnishing a house or an apartment is guided not only by practical considerations but also by his or her own taste. Zehnder's radiators show how individual heating solutions for living areas can be achieved. Their wealth of shapes, colours, dimensions and functions provides inspiration for interior design which is bursting with personality.





Zehnder Charleston



The Zehnder Charleston multi-column design is equally at home in modern environments, and is available in a wide range of stocked horizontal and vertical models, or made-to-measure, including angled and curved.



Technoline 0325



Black-silver hammered 0422



Adjustable foot



Cast iron foot



Copper-black hammered finish 0421

Central Heating Model STOCK listed in black	Height mm	Width mm	Overall Projection	No. of sections	Output $\Delta T=50K$ Watts/btu All outputs certified to EN 442	Weight kg	RRP (ex VAT)	RRP (inc 20%) VAT
Zehnder Charleston Horizontal white RAL 9016								
2050-10	500	490	90	10	384/1310	7.9	£151	£181.20
2050-14	500	674	90	14	538/1836	11.0	£211	£253.20
2050-18	500	858	90	18	691/2358	14.2	£272	£326.40
2050-22	500	1042	90	22	845/2883	17.4	£332	£398.40
2050-26	500	1226	90	26	998/3405	20.5	£393	£471.60
2060-10	600	490	90	10	453/1546	9.5	£156	£187.20
2060-14	600	674	90	14	634/2163	13.3	£218	£261.60
2060-18	600	858	90	18	815/2781	17.1	£281	£337.20
2060-22	600	1042	90	22	997/3402	20.9	£343	£411.60
2060-24	600	1134	90	24	1080/3685	22.8	£374	£448.80
2060-28	600	1318	90	28	1260/4284	26.6	£437	£524.40
3050-14	500	674	128	14	722/2463	16.6	£251	£301.20
3050-18	500	858	128	18	929/3170	21.4	£322	£386.40
3050-22	500	1042	128	22	1135/3873	26.2	£394	£472.80
3050-26	500	1226	128	26	1342/4579	30.9	£465	£558.00
3050-30	500	1410	128	30	1548/5282	35.7	£537	£644.40
3060-10	600	490	128	10	609/2078	13.9	£189	£226.80
3060-14	600	674	128	14	853/2910	19.4	£265	£318.00
3060-18	600	858	128	18	1096/3740	24.9	£340	£408.00
3060-20	600	950	128	20	1220/4163	27.7	£378	£453.60
3060-24	600	1134	128	24	1464/4995	33.2	£454	£544.80
3060-27	600	1272	128	27	1645/5613	37.3	£510	£612.00
3060-30	600	1410	128	30	1827/6234	41.6	£567	£680.40
3060-34	600	1594	128	34	2071/7066	47.0	£643	£771.60
3075-14	750	674	128	14	1040/3548	24.3	£297	£356.40
3075-22	750	1042	128	22	1635/5579	38.2	£466	£559.20
3075-26	750	1226	128	26	1932/6592	45.1	£551	£661.20
4030-20	300	950	164	20	840/2866	21.3	£380	£456.00
4030-30	300	1410	164	30	1260/4299	32.0	£570	£684.00
4060-14	600	674	164	14	1117/3811	27.3	£279	£334.80
4060-18	600	858	164	18	1436/4900	35.1	£358	£429.60
4060-20	600	950	164	20	1600/5459	39.0	£398	£477.60
4060-24	600	1134	164	24	1920/6551	46.8	£478	£573.60
4075-14	750	674	164	14	1364/4654	33.6	£336	£403.20
4075-18	750	858	164	18	1753/5981	43.2	£432	£518.40
4075-22	750	1042	164	22	2143/7312	52.8	£528	£633.60
4075-26	750	1226	164	26	2532/8639	62.5	£624	£748.80

Zehnder Charleston Horizontal anthracite								
3060-10-0346	600	490	128	10	609/2078	13.9	£217	£260.40
3060-14-0346	600	674	128	14	853/2910	19.4	£305	£366.00
3060-18-0346	600	858	128	18	1096/3740	24.9	£391	£469.20
3060-20-0346	600	950	128	20	1220/4163	27.7	£435	£522.00
3060-24-0346	600	1134	128	24	1464/4995	33.2	£522	£626.40
3060-27-0346	600	1272	128	27	1645/5613	37.3	£587	£704.40
3060-30-0346	600	1410	128	30	1827/6234	41.6	£652	£782.40
3060-34-0346	600	1594	128	34	2071/7066	47.0	£739	£886.80

See next page for Accessories

Colour finish: Standard colours from the Zehnder colour chart including matt white finish: white RAL 9016 + 25%. Colour finish and non-stock products delivery: 20-30 working days.

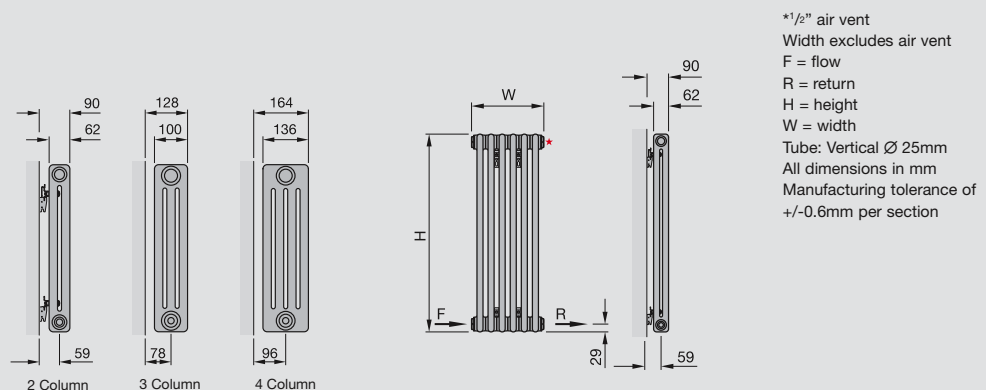

For further technical drawings please see page 79

For full **CE** compliant technical specifications, refer to page 140
To make an approximate conversion from T=50K to T=60K multiply outputs by 1.2

Zehnder Charleston



The Zehnder Charleston multi-column design is equally at home in modern environments, and is available in a wide range of stocked horizontal and vertical models, or made-to-measure, including angled and curved.



Valves: see page 122



Technoline 0325



See page 79



Technoline 0325



Technoline finish

Central Heating Model STOCK listed in black	Height mm	Width mm	Overall Projection	No. of sections	Output $\Delta T=50K$ Watts/btu All outputs certified to EN 442	Weight kg	RRP (ex VAT)	RRP (inc 20% VAT)
Zehnder Charleston Vertical white RAL 9016								
2180-6	1800	306	90	6	744/2539	16.4	£223	£267.60
2180-8	1800	398	90	8	992/3385	21.9	£298	£357.60
2180-10	1800	490	90	10	1240/4231	27.3	£372	£446.40
2180-12	1800	582	90	12	1488/5077	32.8	£446	£535.20
3180-6	1800	306	128	6	996/3398	24.6	£306	£367.20
3180-8	1800	398	128	8	1328/4531	32.8	£408	£489.60
3180-10	1800	490	128	10	1660/5664	41.0	£510	£612.00

Colour finish: Standard colours from the Zehnder colour chart including matt white finish: white RAL 9016 + 25%. Colour finish and non-stock products delivery: 20-30 working days.

Accessories			
Model		RRP (ex VAT)	RRP (inc 20% VAT)
601020	Lambswool cleaning brush	£49	£58.80
Adjustable feet (height 100 to 150mm)			
976131	white	£29	£34.80
976139	colour	£36	£43.20
Cast iron foot for Charleston radiator (height 100mm)			
ZPGG-9016	white	£20	£24.00
Additional Towel Rails			
966018	Charleston chrome towel bar 368mm	£125	£150.00
966028	Charleston chrome towel bar 918mm	£139	£166.80

EasyFix brackets: see page 78. Welded-on-feet: see page 79.

Towel bars can be cut down to size

*1/2" air vent
Width excludes air vent
F = flow
R = return
H = height
W = width
Tube: Vertical \varnothing 25mm
All dimensions in mm
Manufacturing tolerance of ± 0.6 mm per section

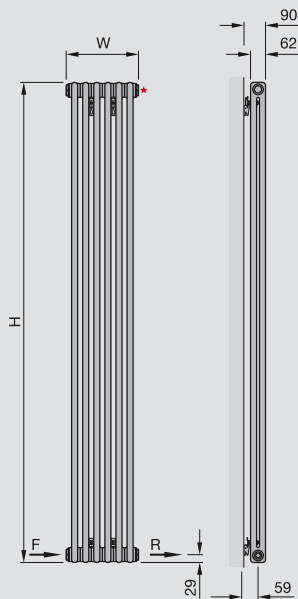

For further technical drawings please see next page

For full compliant technical specifications, refer to page 140
To make an approximate conversion from T=50K to T=60K multiply outputs by 1.2

Zehnder Charleston



The Zehnder Charleston multi-column is available made-to-measure as vertical and horizontal models including angled and curved.

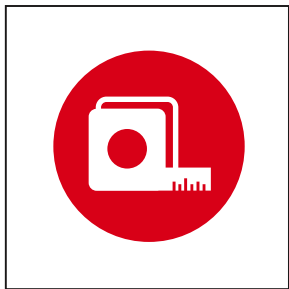

Made-to-measure



Standard CVD brackets supplied with Charleston radiators - colour to match the radiator



EasyFix bracket for radiators 300mm to 1000mm in height



EasyFix bracket for radiators below 260mm and above 1100mm in height



Nominal Height mm	Model code	Output 50ΔT Watts/BTU	RRP white (ex VAT)	RRP colour (ex VAT)	Model code	Output 50ΔT Watts/BTU	RRP white (ex VAT)	RRP colour (ex VAT)	Model code	Output 50ΔT Watts/BTU	RRP white (ex VAT)	RRP colour (ex VAT)
Zehnder Charleston - 2 column					3 column				4 column			
200	2019	15/49	£14.70	£18.38	3019	20/69	£17.30	£21.63	4019	28/97	£18.90	£23.63
300	2030	24/81	£14.80	£18.50	3030	32/109	£17.40	£21.75	4030	42/143	£19.00	£23.75
400	2040	31/106	£14.90	£18.63	3040	42/143	£17.60	£22.00	4040	55/187	£19.20	£24.00
450	2045	35/119	£15.00	£18.75	3045	47/160	£17.70	£22.13	4045	61/209	£19.30	£24.13
500	2050	38/131	£15.10	£18.88	3050	52/176	£17.90	£22.38	4050	68/232	£19.40	£24.25
550	2055	42/143	£15.30	£19.13	3055	56/192	£18.60	£23.25	4055	74/251	£19.60	£24.50
600	2060	45/155	£15.60	£19.50	3060	61/208	£18.90	£23.63	4060	80/272	£19.90	£24.88
750	2075	55/188	£18.10	£22.63	3075	74/254	£21.20	£26.50	4075	97/332	£24.00	£30.00
900	2090	64/218	£20.90	£26.13	3090	87/297	£24.00	£30.00	4090	114/389	£28.10	£35.13
1000	2100	70/239	£23.00	£28.75	3100	95/324	£26.00	£32.50	4100	125/427	£31.60	£39.50
1200	2120	83/282	£28.60	£35.75	3120	115/392	£34.70	£43.38	4120	147/502	£43.90	£54.88
1500	2150	104/355	£33.70	£42.13	3150	140/478	£40.80	£51.00	4150	180/614	£56.10	£70.13
1800	2180	124/423	£37.20	£46.50	3180	166/566	£51.00	£63.75	4180	213/727	£60.20	£75.25
2000	2200	138/471	£39.80	£49.75	3200	183/624	£57.10	£71.38	4200	234/798	£65.30	£81.63

Nominal Height mm	Model code	Output 50ΔT Watts/BTU	RRP white (ex VAT)	RRP colour (ex VAT)
Zehnder Charleston - 5 column				
200	5019	35/119	£24.50	£30.63
300	5030	52/177	£25.00	£31.25
400	5040	68/232	£26.00	£32.50
450	5045	76/259	£27.00	£33.75
500	5050	84/285	£27.50	£34.38
550	5055	91/310	£28.60	£35.75
600	5060	99/336	£29.60	£37.00
750	5075	120/409	£30.60	£38.25
900	5090	141/481	£34.70	£43.38
1000	5100	154/525	£39.80	£49.75
1200	5120	179/611	£52.00	£65.00
1500	5150	219/747	£69.40	£86.75

Model code	Output 50ΔT Watts/BTU	RRP white (ex VAT)	RRP colour (ex VAT)
6 column			
6019	42/142	£30.60	£38.25
6030	61/209	£31.10	£38.88
6040	81/275	£32.60	£40.75
6045	90/306	£33.40	£41.75
6050	99/338	£34.20	£42.75
6055	108/369	£35.20	£44.00
6060	117/399	£36.20	£45.25
6075	143/488	£37.70	£47.13
6090	167/570	£43.90	£54.88
6100	183/624	£50.00	£62.50
6120	210/717	£65.30	£81.63
6150	256/873	£81.60	£102.00

All data and prices per 46mm section





Dimensions:

Nominal overall radiator length = (No. of sections x 46mm) + 30mm
(Manufacturing tolerance of ± 0.6 mm per section).

Selection example:

Output required: approximately 1000 watts
Dimensions required:
approximately 600mm H x 900mm L
Formula: (No. of sections x 46mm) + 30mm
Calculation of sections:
900mm - 30mm divided by 46 = 19 sections
1000w divided by 19 section =
approximately 52 watts/section required
Radiator selection: 3050 = 52 watts/section
52w x 19 section = 988 watts (50Δt)
Price calculation:
19 sections x £17.90 = £340.10 plus vat

Colour finish: Standard colours from the Zehnder colour chart including matt white finish: white RAL 9016 + 25%. Colour finish and non-stock products delivery: 20-30 working days.

Foot support options (wall brackets included as standard)				
Model	No of Feet	RRP white (ex VAT)	RRP colour (ex VAT)	
Welded-on fixed (150mm) or adjustable (120-170mm). Price per radiator				
	1 - 20 sections	2	£59.00	£73.75
	21 - 40 sections	3	£88.50	£110.63
	41 - 60 sections	4	£118.00	£147.50
Welded-on traditional foot (100mm or 150mm). Price per radiator				
	1 - 20 sections	2 pairs	£82.00	£102.50
	21 - 40 sections	3 pairs	£123.00	£153.75
	41 - 60 sections	4 pairs	£164.00	£205.00
Adjustable foot (100-150mm). Price per foot				
	976131 white	1	£29.00	
	976139 colour	1		£36.00
Must always be used with wall brackets				
Cast iron foot (100mm high). Price per foot				
	ZPGG-9016	1	£20.00	

EasyFix brackets available to order on application

Please note: We only supply complete radiators.
Additional sections cannot be joined to our stock range of radiators.
Prices for curved or angled radiators on application.
The number of sections/length is virtually unlimited. Practicality regarding weights, handling and accessibility should be taken into consideration.
Large radiators may be supplied in modules to be assembled on site.

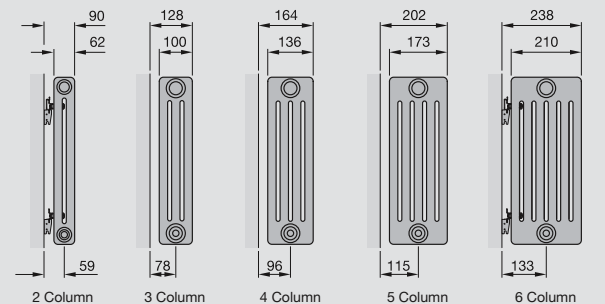

Accessories			
Additional Charleston Towel Rails		RRP (ex VAT)	RRP (inc VAT)
	966018 chrome 368mm bar	£125	£150.00
	966028 chrome 918mm bar	£139	£166.80

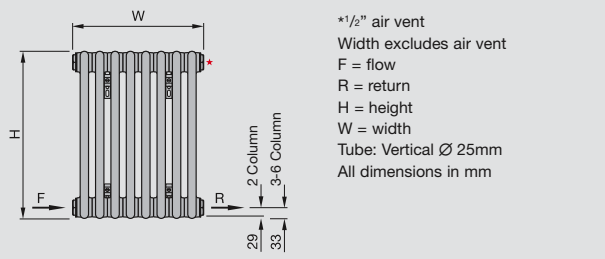

For full CE compliant technical specifications, refer to page 141
To make an approximate conversion from T=50K to T=60K multiply outputs by 1.2

Zehnder Charleston Mirror



Warmth and comfort with a full-length mirror to enhance its elegance.



Valves: see page 122



Zehnder Charleston Relax



Practical and clever for modern life styles, especially ideal for hallways and conservatories.



Valves: see page 122



Central Heating Model STOCK listed in black	Height mm	Width mm	Finish	Depth mm	Output $\Delta T=50K$ Watts/btu All outputs certified to EN 442	Centre from wall	Overall projection	Weight kg	RRP (ex VAT)	RRP (inc 20% VAT)
Zehnder Charleston Mirror										
CM2180-12	1792	552	white	83	1401/4780	74	126	33.6	£537	£644.40
CM2180-16	1792	736	white	83	1792/6114	74	126	44.8	£629	£754.80

Colour finish: Standard colours from the Zehnder colour chart including matt white finish: white RAL 9016 + 25%. Colour finish and non-stock products delivery: 20-30 working days.

Accessories

Model		RRP (ex VAT)	RRP (inc 20% VAT)
601020	Lambswool cleaning brush	£49	£58.80
Adjustable feet (height 100 to 150mm)			
976131	white	£29	£34.80
976139 + colour	colour	£36	£43.20
Cast iron foot (height 100mm)			
ZPGG-9016	white	£20	£24.00

*1/2" air vent
F = flow
R = return
H = height
W = width
Tube: \varnothing 25mm
All dimensions in mm

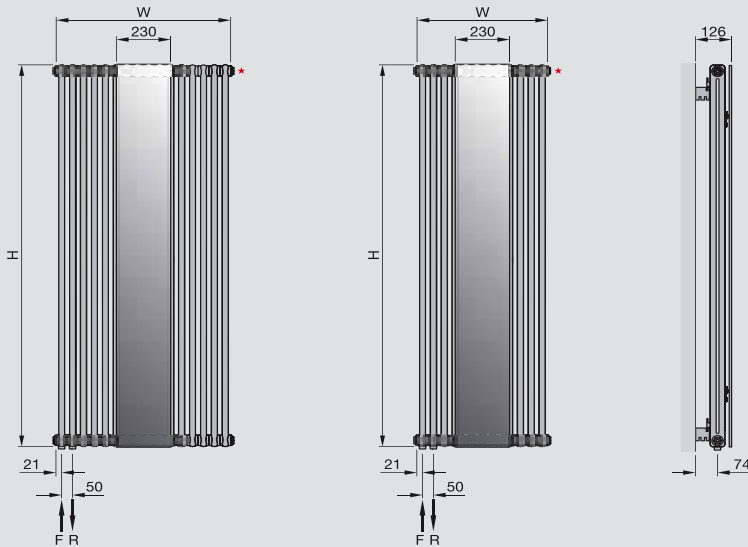

Central Heating Model STOCK listed in black	Height mm	Width mm	Finish	Depth mm	Output $\Delta T=50K$ Watts/btu All outputs certified to EN 442	Centre from wall	Overall projection	Weight kg	RRP (ex VAT)	RRP (inc 20% VAT)
Zehnder Charleston Relax										
CR5026-13	455	800	white	250	543/1852	195	320	18.6	£612	£734.40
CR5026-18	455	1000	white	250	747/2549	195	320	25.1	£679	£814.80

Bench seat: multiplex wood with beech finish

Colour finish: Standard colours from the Zehnder colour chart including matt white finish: white RAL 9016 + 25%. Colour finish and non-stock products delivery: 20-30 working days.

Accessories

Model		RRP (ex VAT)	RRP (inc 20% VAT)
819058	Chrome TRV Head (M30 x 1.5) note: TRV Head not supplied with the radiator	£35	£42.00
601020	Lambswool cleaning brush	£49	£58.80

*1/2" air vent
F = flow
R = return
H = height
W = width
Tube: \varnothing 25mm
All dimensions in mm

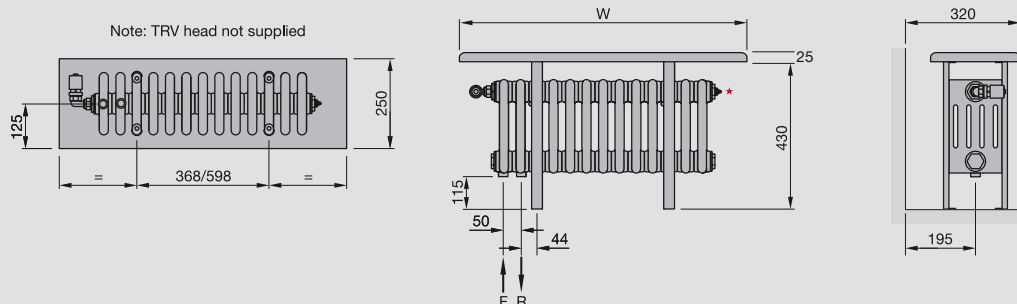

For full **CE** compliant technical specifications, refer to page 142
To make an approximate conversion from T=50K to T=60K multiply outputs by 1.2

Zehnder Metropolitan



The Zehnder Metropolitan has a contemporary, minimalist appearance. Designed in Italy by the award-winning King and Miranda, the Metropolitan has beautiful clean cut lines to give a geometric shape with stylish sloping edges.



Amethyst Quartz



Valves: see page 122



White Aluminium

Central Heating Model STOCK listed in black	Height mm	Width mm	No. of sections	Finish	Output $\Delta T=50K$ Watts/btu All outputs certified to EN 442	Weight kg	RRP (ex VAT)	RRP (inc 20%) VAT
 Zehnder Metropolitan vertical tubes								
MEV-180-030	1800	280	3	white	490/1672	11.3	£353	£423.60
MEV-180-040	1800	385	4	white	643/2194	14.6	£408	£489.60
MEV-180-050	1800	490	5	white	791/2699	17.9	£468	£561.60
MEV-180-060	1800	595	6	white	934/3187	21.3	£532	£638.40
MEV-200-040	2000	385	4	white	714/2436	16.1	£448	£537.60
MEV-200-050	2000	490	5	white	878/2996	19.8	£518	£621.60
MEV-200-060	2000	595	6	white	1037/3538	23.5	£590	£708.00
MEV-180-030-0336	1800	280	3	volcanic	490/1672	11.3	£441	£529.20
MEV-180-040-0336	1800	385	4	volcanic	643/2194	14.6	£510	£612.00
MEV-180-050-0336	1800	490	5	volcanic	791/2699	17.9	£585	£702.00

 **Colour finish:** Standard colours from the Zehnder colour chart including matt white finish: white RAL 9016 + 25%. Colour finish and non-stock products delivery: 20-30 working days.

*1/2" air vent
 Frame: 70mm x 39mm triangular tubes
 Flat tubes: 70mm x 8mm
 F = flow
 R = return
 H = height
 W = width
 All dimensions in mm

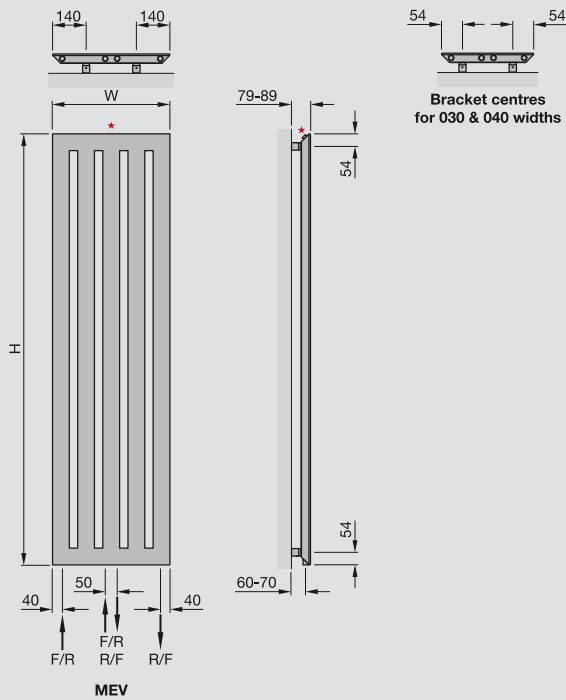

Zehnder Metropolitan



The Zehnder Metropolitan has clean lines and a contemporary, modern appeal. The Metropolitan is available in both landscape and portrait formats, with an optional bar as a useful yet attractive accessory.

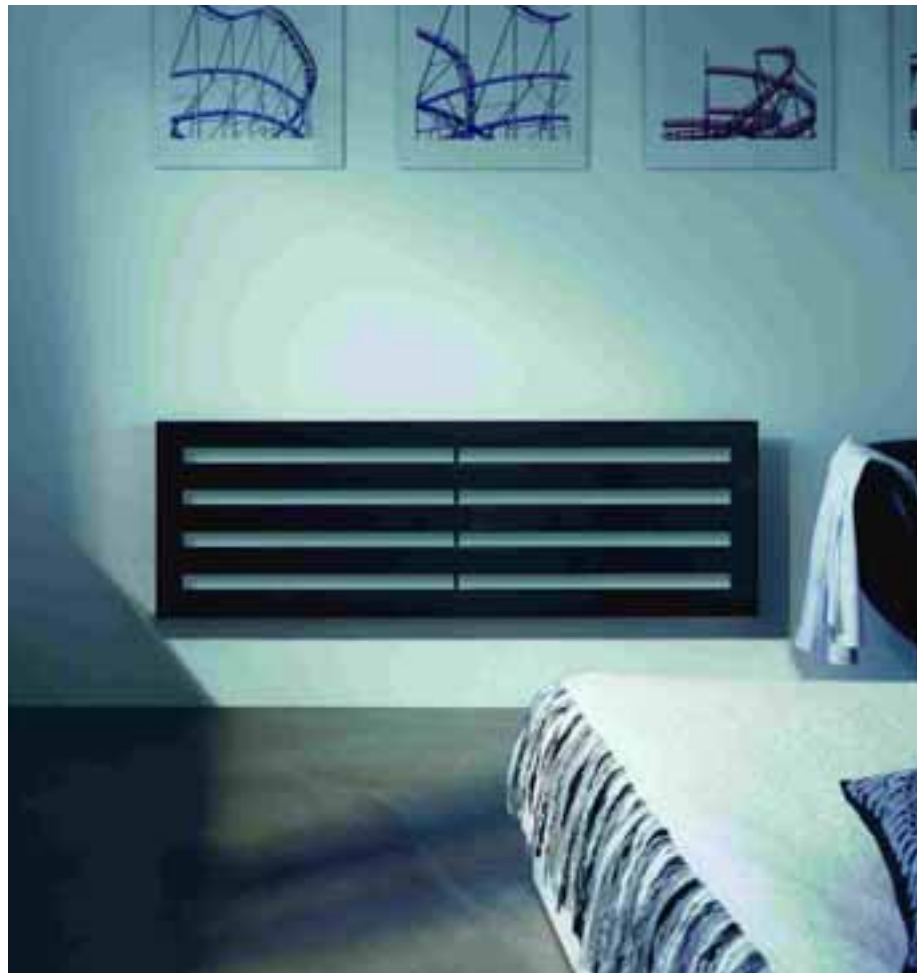

Volcanic

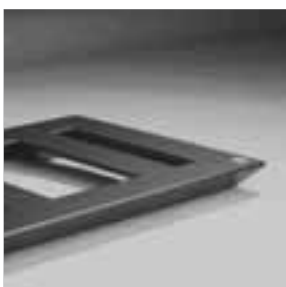

Volcanic



Gold Look

Central Heating Model STOCK listed in black	Height mm	Width mm	No. of sections	Finish	Output $\Delta T=50K$ Watts/btu All outputs certified to EN 442	Weight kg	RRP (ex VAT)	RRP (inc 20% VAT)
 Zehnder Metropolitan horizontal tubes								
MEH-030-140	280	1400	3	white	376/1283	8.31	£357	£428.40
MEH-040-140	385	1400	4	white	474/1617	10.3	£408	£489.60
MEH-040-160	385	1600	4	white	542/1849	11.7	£422	£506.40
MEH-050-140	490	1400	5	white	585/1996	12.8	£445	£534.00
MEH-050-160	490	1600	5	white	669/2283	14.6	£460	£552.00
MEH-050-180	490	1800	5	white	753/2569	16.3	£480	£576.00
MEH-060-090	595	900	6	white	447/1525	10.1	£445	£534.00
MEH-060-140	595	1400	6	white	695/2371	15.3	£489	£586.80
MEH-060-160	595	1600	6	white	794/2709	17.4	£509	£610.80
MEH-060-180	595	1800	6	white	894/3050	19.5	£528	£633.60
MEH-060-200	595	2000	6	white	993/3388	21.6	£550	£660.00
MEH-080-050	805	500	8	white	387/1320	8.2	£402	£482.40
MEH-080-060	805	600	8	white	449/1532	9.7	£415	£498.00
MEH-120-040	1225	400	12	white	469/1600	10.3	£439	£526.80
MEH-120-050	1225	500	12	white	563/1921	12.4	£447	£536.40
MEH-120-060	1225	600	12	white	653/2228	14.5	£464	£556.80
MEH-150-040	1540	400	15	white	582/1986	12.0	£518	£621.60
MEH-150-050	1540	500	15	white	730/2491	14.4	£527	£632.40
MEH-150-060	1540	600	15	white	871/2972	16.8	£545	£654.00
MEH-180-040	1750	400	17	white	663/2262	14.4	£579	£694.80
MEH-180-050	1750	500	18	white	795/2713	17.4	£589	£706.80

 **Colour finish:** Standard colours from the Zehnder colour chart including matt white finish: white RAL 9016 + 25%. Colour finish and non-stock products delivery: 20-30 working days.

MEH accessories

Model		RRP (ex VAT)	RRP (inc 20% VAT)
468038	Towel-bar for 400 mm width radiator, chrome plated	£89	£106.80
468048	Towel-bar for 500 mm width radiator, chrome plated	£91	£109.20
468058	Towel-bar 600 mm width radiator, two fixing points, chrome plated	£94	£112.80
480438	Set of hooks (2 pcs.), to clip on, chrome plated	£40	£48.00

*1/2" air vent
 Frame: 70mm x 39mm triangular tubes
 Flat tubes: 70mm x 8mm
 F = flow
 R = return
 H = height
 W = width
 All dimensions in mm

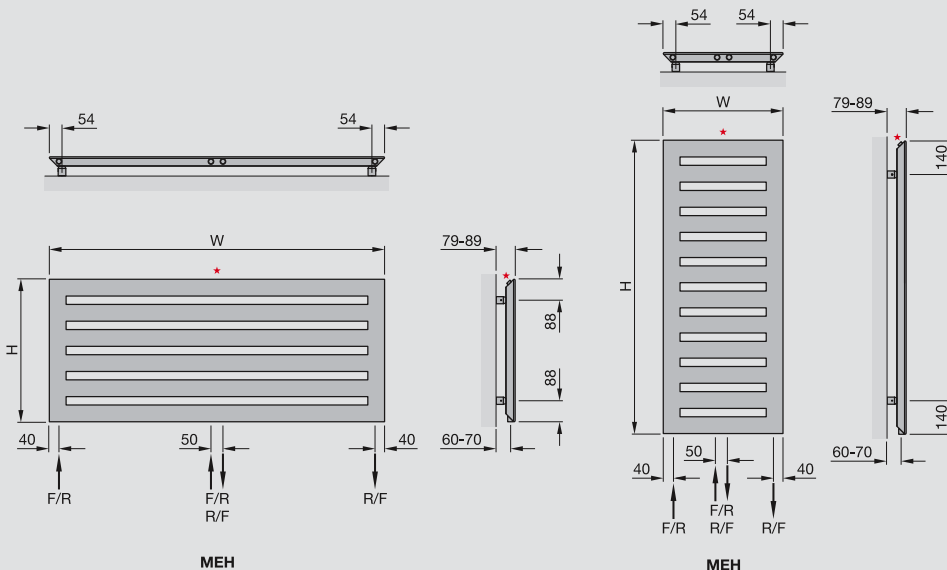

For full  compliant technical specifications, refer to page 142
 To make an approximate conversion from T=50K to T=60K multiply outputs by 1.2

Zehnder Roda



A simple, effective and efficient design radiator, the Zehnder Roda radiator is perfect for all living areas, and is also available made-to-measure.



Accessories: see page 121



Valves: see page 122



Central Heating Model STOCK listed in black	Height mm	Width mm	Overall projection	Finnish	Number of tubes	Output $\Delta T=50K$ Watts/btu All outputs certified to EN 442	Weight kg	RRP (ex VAT)	RRP (inc 20% VAT)
🔥 Zehnder Roda Vertical Single panel									
ROV-180-029	1800	296	70	white	4	568/1940	12.0	£252	£302.40
ROV-180-037	1800	370	70	white	5	710/2425	15.0	£315	£378.00
ROV-180-044	1800	444	70	white	6	852/2910	18.0	£378	£453.60
ROV-180-051	1800	518	70	white	7	994/3395	21.0	£441	£529.20
ROV-180-059	1800	592	70	white	8	1136/3880	24.0	£504	£604.80
ROV-180-066	1800	666	70	white	9	1278/4365	27.0	£567	£680.40

🔥 Zehnder Roda Vertical Double panel									
ROVD-180-029	1800	296	93	white	4	824/2812	22.4	£464	£556.80
ROVD-180-037	1800	370	93	white	5	1030/3515	28.0	£580	£696.00
ROVD-180-044	1800	444	93	white	6	1236/4218	33.6	£696	£835.20
ROVD-180-051	1800	518	93	white	7	1442/4921	39.2	£812	£974.40
ROVD-180-059	1800	592	93	white	8	1648/5624	44.8	£928	£1,113.60
ROVD-180-066	1800	666	93	white	9	1854/6327	50.4	£1,044	£1,252.80

ROV & ROVD can be installed horizontally with TBSE connections either side.

Central Heating Model STOCK listed in black	Height mm	Width mm	Overall projection	Finnish	Number of tubes	Output $\Delta T=50K$ Watts/btu All outputs certified to EN 442	Weight kg	RRP (ex VAT)	RRP (inc 20% VAT)
🔥 Zehnder Roda Horizontal Single panel									
ROH-052-100	518	1000	70	white	7	586/1999	13.4	£311	£373.20
ROH-052-120	518	1200	70	white	7	703/2399	16.1	£373	£447.60
ROH-059-100	592	1000	70	white	8	665/2269	14.1	£337	£404.40
ROH-059-120	592	1200	70	white	8	798/2723	18.1	£404	£484.80
ROH-059-140	592	1400	70	white	8	931/3177	19.7	£472	£566.40

🔥 Zehnder Roda Horizontal Single panel with single convector fin									
ROHL-059-060	592	600	92	white	8	636/2170	13.2	£293	£351.60
ROHL-059-080	592	800	92	white	8	848/2894	17.6	£391	£469.20
ROHL-059-100	592	1000	92	white	8	1060/3617	22.0	£489	£586.80
ROHL-059-120	592	1200	92	white	8	1272/4340	26.4	£587	£704.40

🔥 Zehnder Roda Horizontal Double panel									
ROHD-059-060	592	600	93	white	8	641/2187	16.5	£364	£436.80
ROHD-059-080	592	800	93	white	8	855/2916	22.0	£486	£583.20
ROHD-059-100	592	1000	93	white	8	1069/3645	27.4	£607	£728.40
ROHD-059-120	592	1200	93	white	8	1283/4374	32.9	£728	£873.60

🔥 Colour finish: Standard colours from the Zehnder colour chart including matt white finish: white RAL 9016 + 25%. Colour finish and non-stock products delivery: 20-30 working days.

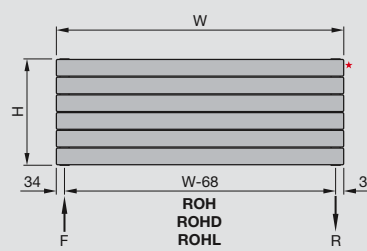
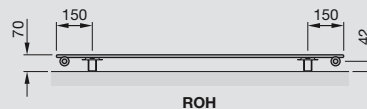
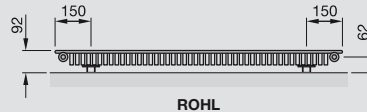
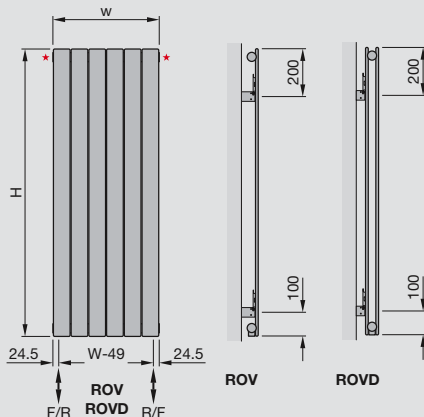
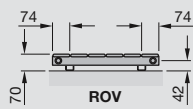
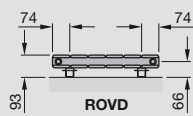

*1/8" air vent
Width excludes air vent
F = flow
R = return
H = height
W = width
Tube dimensions 70mm x 11mm
Vertical tubes: \varnothing 38mm
All dimensions in mm

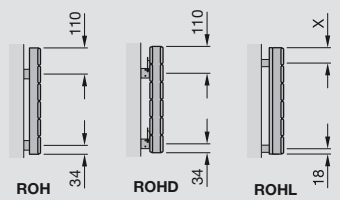

ROHL: Refer to page 89

flow & return can be manufactured reversed on request

For full **CE** compliant technical specifications, refer to page 143
To make an approximate conversion from T=50K to T=60K multiply outputs by 1.2

Zehnder Roda



Made-to-measure Zehnder Roda radiators are easy and quick to order. They are simple, effective and efficient decorative radiators, available as horizontal or vertical, and are perfect for all living areas.



Made-to-measure



Valves: see page 122



Zehnder Roda (ROV) vertical, single panel white										
Width		Height (mm)								
(mm)	No of tubes	ROV-060 600	ROV-080 800	ROV-100 1000	ROV-120 1200	ROV-140 1400	ROV-160 1600	ROV-180 1800	ROV-200 2000	ROV-220 2200
444	6	£264	£294	£312	£324	£342	£354	£378	£426	£492
518	7	£308	£343	£364	£378	£399	£413	£441	£497	£574
592	8	£352	£392	£416	£432	£456	£472	£504	£568	£656
666	9	£396	£441	£468	£486	£513	£531	£567	£639	£738
740	10	£440	£490	£520	£540	£570	£590	£630	£710	£820
814	11	£484	£539	£572	£594	£627	£649	£693	£781	£902
888	12	£528	£588	£624	£648	£684	£708	£756	£852	£984
Technical data per tube	Weight (kg)	1.3	1.6	1.9	2.1	2.4	2.7	3.0	3.3	3.6
	Output 50ΔT Watts/BTU	52/177	68/232	83/283	98/334	113/386	127/433	142/485	155/529	169/577

Output calculation example 50Δt (watts): 1800H x 592W: 142 x 8 = 1136w

Zehnder Roda (ROVD) vertical, double panel white										
Width		Height (mm)								
(mm)	No of tubes	ROVD-060 600	ROVD-080 800	ROVD-100 1000	ROVD-120 1200	ROVD-140 1400	ROVD-160 1600	ROVD-180 1800	ROVD-200 2000	ROVD-220 2200
444	6	£480	£528	£570	£582	£612	£636	£696	£798	£888
518	7	£560	£616	£665	£679	£714	£742	£812	£931	£1,036
592	8	£640	£704	£760	£776	£816	£848	£928	£1,064	£1,184
666	9	£720	£792	£855	£873	£918	£954	£1,044	£1,197	£1,332
740	10	£800	£880	£950	£970	£1,020	£1,060	£1,160	£1,330	£1,480
814	11	£880	£968	£1,045	£1,067	£1,122	£1,166	£1,276	£1,463	£1,628
888	12	£960	£1,056	£1,140	£1,164	£1,224	£1,272	£1,392	£1,596	£1,776
Technical data per tube	Weight (kg)	2.1	2.7	3.3	3.9	4.4	5.0	5.6	6.2	6.7
	Output 50ΔT (Watts/BTU)	77/263	100/341	122/416	144/491	165/563	186/635	206/703	225/768	244/833

Output calculation example 50Δt (watts): 1800H x 592W: 206 x 8 = 1648w

Zehnder Roda (ROH) horizontal, single panel white													
Model Code	Height		Technical data per metre		Width (mm)								
	(mm)	No of tubes	Weight (kg)	Output 50ΔT Watts/BTU	600	800	1000	1200	1400	1600	1800	2000	2200
ROH-030	296	4	7.2	344/1174	£140	£186	£233	£280	£326	£373	£419	£466	£513
ROH-037	370	5	9.0	425/1450	£155	£207	£259	£311	£363	£414	£466	£518	£570
ROH-044	444	6	10.7	506/1726	£171	£228	£285	£342	£399	£456	£513	£570	£627
ROH-052	518	7	12.4	586/1999	£187	£249	£311	£373	£435	£498	£560	£622	£684
ROH-059	592	8	14.1	665/2269	£202	£270	£337	£404	£472	£539	£607	£674	£741

Output calculation example 50Δt (watts): 518H x 1200L: 586 x 1.2 = 667w

Zehnder Roda (ROHD) horizontal, single panel, single fin white													
Model Code	Height		Technical data per metre		Width (mm)								
	(mm)	No of tubes	Weight (kg)	Output 50ΔT Watts/BTU	600	800	1000	1200	1400	1600	1800	2000	2200
ROHD-014	148	2	7.0	350/1194	£157	£210	£262	£314	£367	£419	£472	£524	£576
ROHD-022	222	3	10.7	511/1744	£180	£240	£300	£360	£420	£480	£540	£600	£660
ROHD-030	296	4	14.3	637/2173	£203	£270	£338	£406	£473	£541	£608	£676	£744
ROHD-037	370	5	16.1	719/2453	£226	£301	£376	£451	£526	£602	£677	£752	£827
ROHD-044	444	6	18.7	845/2883	£248	£330	£413	£496	£578	£661	£743	£826	£909
ROHD-052	518	7	19.5	927/3163	£271	£361	£451	£541	£631	£722	£812	£902	£992
ROHD-059	592	8	23.6	1060/3617	£293	£391	£489	£587	£685	£782	£880	£978	£1,076

Output calculation example 50Δt (watts): 518H x 1200L: 927 x 1.2 = 1112w

Details on intermediate sizes are available on request (1-20 tubes)

Colour finish: Standard colours from the Zehnder colour chart including matt white finish: white RAL 9016 + 25%. Colour finish and non-stock products delivery: 20-30 working days.

All prices exclude VAT

For full  compliant technical specifications, refer to page 143

To make an approximate conversion from T=50K to T=60K multiply outputs by 1.2

Zehnder Roda Mirror



Warmth and comfort with a full length mirror to enhance its elegance, the Zehnder Roda Mirror is an asset to any home.



Accessories: see page 121



Valves: see page 122



Ruby Red

Central Heating Model STOCK listed in black	Height mm	Width mm	Finish	Number of elements	Output $\Delta T=50K$ Watts/btu All outputs certified to EN 442	Weight kg	RRP (ex VAT)	RRP (inc 20% VAT)
 Zehnder Roda Mirror								
ROM-180-067	1800	666	white	3+2	680/2320	24.6	£606	£727.20
ROM-180-081	1800	814	white	5+2	952/3248	31.0	£695	£834.00
ROMD-180-067	1800	666	white	6+4	1355/4623	51.6	£1,091	£1,309.20
ROMD-180-081	1800	814	white	10+4	1527/5210	64.0	£1,251	£1,501.20

 **Colour finish:** Standard colours from the Zehnder colour chart including matt white finish: white RAL 9016 + 25%. Colour finish and non-stock products delivery: 20-30 working days.

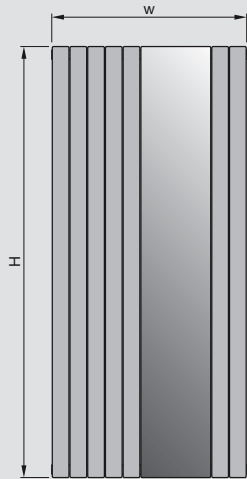
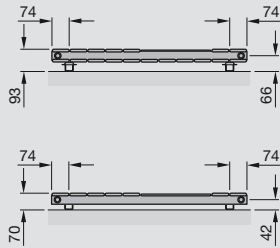

ROM-180-081
ROMD-180-081

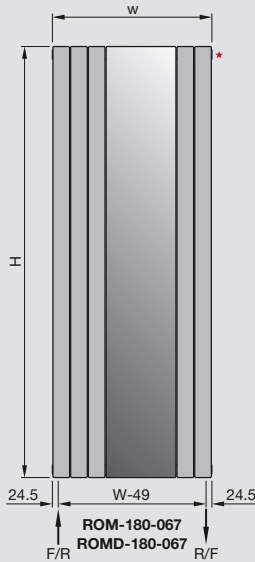

ROM-180-067
ROMD-180-067

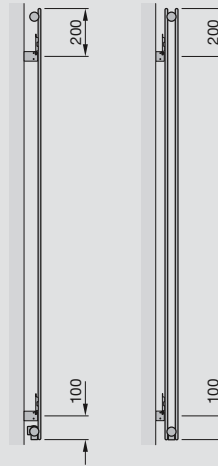

*1/8" air vent
Width excludes air vent
F = flow
R = return
H = height
W = width
Tube: Dimensions 70mm x 11mm
Tube: Horizontal tubes: \varnothing 38mm
All dimensions in mm

Zehnder Ax



Also available made-to-measure, the unique Zehnder Ax with its slim-line single or double tubes adds comfort and style to your home.



Zehnder Taurus double hook: see page 121



Valves: see page 122



Titane



White Aluminium

Central Heating Model STOCK listed in black	Height mm	Width mm	Number of tubes	Finish	Output $\Delta T=50K$ Watts/btu All outputs certified to EN 442	Pipe centres	Weight kg	RRP (ex VAT)	RRP (inc 20% VAT)
Zehnder Ax Vertical Single Panel									
ZAV-180-035	1800	352	8	white	704/2196	303	12.9	£312	£374.40
ZAV-180-044	1800	440	10	white	880/3003	391	16.1	£390	£468.00
ZAV-180-053	1800	528	12	white	1056/4468	479	19.3	£468	£561.60
ZAV-180-061	1800	616	14	white	1232/4204	567	22.5	£546	£655.20

Central Heating Model STOCK listed in black	Height mm	Width mm	Number of tubes	Finish	Output $\Delta T=50K$ Watts/btu All outputs certified to EN 442	Pipe centres	Weight kg	RRP (ex VAT)	RRP (inc 20% VAT)
Zehnder Ax Horizontal Double Panel									
ZAHD-061-080	616	800	14	white	884/3016	750	19.9	£454	£544.80
ZAHD-061-100	616	1000	14	white	1105/3770	950	24.9	£568	£681.60
ZAHD-061-120	616	1200	14	white	1326/4524	1150	29.8	£682	£818.40
ZAHD-061-140	616	1400	14	white	1547/5278	1350	34.8	£795	£954.00

Colour finish: Standard colours from the Zehnder colour chart including matt white finish: white RAL 9016 + 25%. Colour finish and non-stock products delivery: 20-30 working days.

*1/8" air vent
Width excludes air vent
F = flow
R = return
H = height
W = width
Tube: Horizontal \varnothing 38x10.5
Tube: Vertical \varnothing 38mm
All dimensions in mm

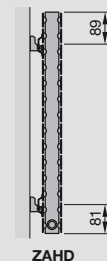
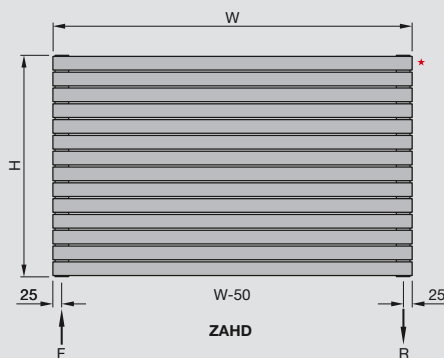
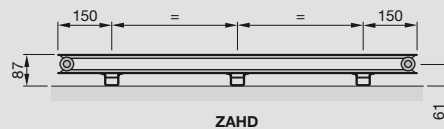
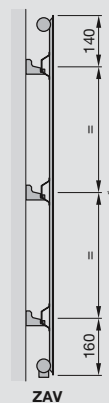
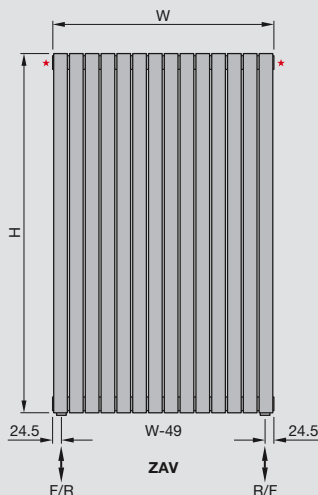
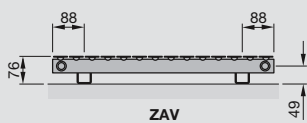

For full **CE** compliant technical specifications, refer to page 144
To make an approximate conversion from T=50K to T=60K multiply outputs by 1.2

Zehnder Ax



Purchased from stock or made-to-measure, the Zehnder Ax, with its unique slim-line single or double tubes, can meet any central heating requirement.



Made-to-measure



Valves: see page 122

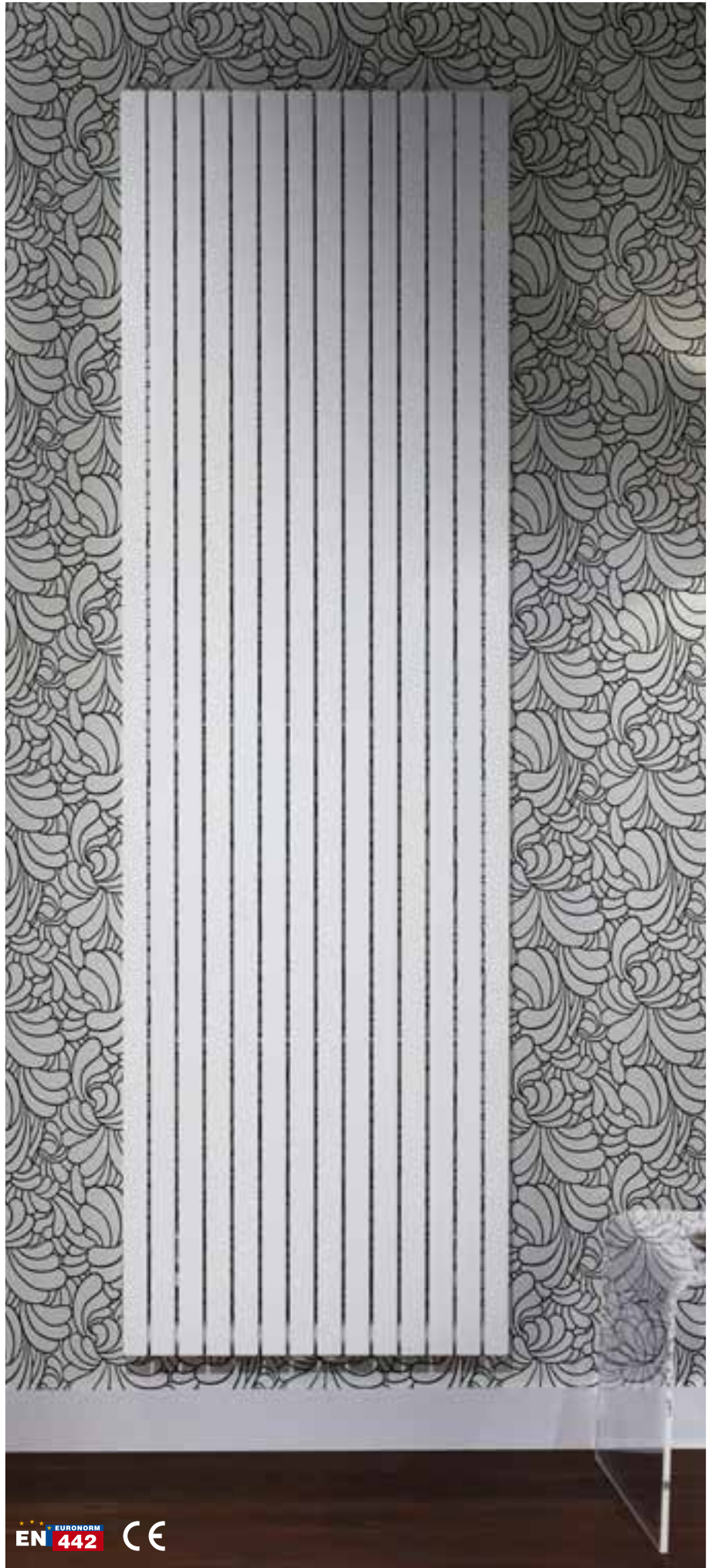

Zehnder Ax (ZAV) vertical single panel										
Width		Model Code / Height (mm)								
(mm)	No of tubes	ZAV-060 600	ZAV-080 800	ZAV-100 1000	ZAV-120 1200	ZAV-140 1400	ZAV-160 1600	ZAV-180 1800	ZAV-200 2000	ZAV-220 2200
264	6	£162	£174	£186	£198	£210	£222	£234	£252	£264
352	8	£216	£232	£248	£264	£280	£296	£312	£336	£352
440	10	£270	£290	£310	£330	£350	£370	£390	£420	£440
528	12	£324	£348	£372	£396	£420	£444	£468	£504	£528
616	14	£378	£406	£434	£462	£490	£518	£546	£588	£616
704	16	£432	£464	£496	£528	£560	£592	£624	£672	£704
792	18	£486	£522	£558	£594	£630	£666	£702	£756	£792
880	20	£540	£580	£620	£660	£700	£740	£780	£840	£880
968	22	£594	£638	£682	£726	£770	£814	£858	£924	£968
Technical data per tube	Weight (kg)	0.6	0.8	1.0	1.1	1.3	1.5	1.2	1.8	2.0
	Output 50ΔT Watts/BTU	33/113	42/144	51/175	60/206	70/237	79/269	88/300	98/333	107/365

Output calculation example 50Δt (watts): 1800H x 528L: 12 x 88 = 1056w

Zehnder Ax (ZAVD) vertical double panel										
Width		Model Code / Height (mm)								
(mm)	No of tubes	ZAVD-060 600	ZAVD-080 800	ZAVD-100 1000	ZAVD-120 1200	ZAVD-140 1400	ZAVD-160 1600	ZAVD-180 1800	ZAVD-200 2000	ZAVD-220 2200
264	6	£270	£288	£318	£348	£372	£402	£408	£444	£468
352	8	£360	£384	£424	£464	£496	£536	£544	£592	£624
440	10	£450	£480	£530	£580	£620	£670	£680	£740	£780
528	12	£540	£576	£636	£696	£744	£804	£816	£888	£936
616	14	£630	£672	£742	£812	£868	£938	£952	£1,036	£1,092
704	16	£720	£768	£848	£928	£992	£1,072	£1,088	£1,184	£1,248
792	18	£810	£864	£954	£1,044	£1,116	£1,206	£1,224	£1,332	£1,404
880	20	£900	£960	£1,060	£1,160	£1,240	£1,340	£1,360	£1,480	£1,560
968	22	£990	£1,056	£1,166	£1,276	£1,364	£1,474	£1,496	£1,628	£1,716
Technical data per tube	Weight (kg)	1.1	1.5	1.8	2.1	2.4	2.8	3.1	3.4	3.8
	Output 50ΔT Watts/BTU	51/174	66/223	80/272	94/320	108/368	122/416	136/464	150/512	164/560

Output calculation example 50Δt (watts): 1800H x 528L: 12 x 136 = 1632w

Zehnder Ax (ZAH) horizontal single panel													
Model Code	Height		Technical data per metre		Width (mm)								
	(mm)	No of tubes	Weight (kg)	Output 50ΔT Watts/BTU	600	800	1000	1200	1400	1600	1800	2000	2200
ZAH-026	264	6	6.1	308/1051	£169	£225	£281	£337	£393	£450	£506	£562	£618
ZAH-035	352	8	8.0	414/1413	£181	£242	£302	£362	£423	£483	£544	£604	£664
ZAH-044	440	10	10.0	520/1774	£201	£268	£335	£402	£469	£536	£603	£670	£737
ZAH-053	528	12	11.9	625/2133	£224	£299	£374	£449	£524	£598	£673	£748	£823
ZAH-062	616	14	13.8	730/2491	£236	£314	£393	£472	£550	£629	£707	£786	£865

Output calculation example 50Δt (watts): 616H x 1400L: 1.4 x 730 = 1022w

Zehnder Ax (ZAHD) horizontal double panel													
Model Code	Height		Technical data per metre		Width (mm)								
	(mm)	No of tubes	Weight (kg)	Output 50ΔT Watts/BTU	600	800	1000	1200	1400	1600	1800	2000	2200
ZAHD-026	264	6	11.0	529/1805	£209	£279	£349	£419	£489	£558	£628	£698	£768
ZAHD-035	352	8	14.6	680/2320	£234	£312	£390	£468	£546	£624	£702	£780	£858
ZAHD-044	440	10	18.1	825/2815	£280	£374	£467	£560	£654	£747	£841	£934	£1,027
ZAHD-053	528	12	21.7	966/3296	£317	£422	£528	£634	£739	£845	£950	£1,056	£1,162
ZAHD-062	616	14	25.3	1105/3770	£341	£454	£568	£682	£795	£909	£1,022	£1,136	£1,250

Output calculation example 50Δt (watts): 616H x 1400L: 1.4 x 1105 = 1547w

 **Colour finish:** Standard colours from the Zehnder colour chart including matt white finish: white RAL 9016 + 25%. Colour finish and non-stock products delivery: 20-30 working days.

All prices exclude VAT

For full  compliant technical specifications, refer to page 145

To make an approximate conversion from T=50K to T=60K multiply outputs by 1.2

Zehnder Kleo



Elegant single tubed vertical radiators stocked in white and chrome and available in made-to-measure options. See page 100.



Anthracite

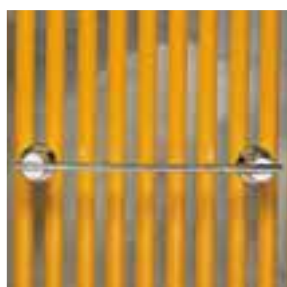

Standard towel bar:
see page 121



Valves: see page 122





Central Heating Model STOCK listed in black	Height mm	Width mm	Number of tubes	Finish	Output $\Delta T=50K$ Watts/btu All outputs certified to EN 442	Pipe centres	Weight kg	RRP (ex VAT)	RRP (inc 20% VAT)
 Zehnder Kleo vertical single panel									
KLV-180-030	1800	299	9	white	632/2156	248	10.3	£227	£272.40
KLV-180-040	1800	398	12	white	842/2874	347	13.7	£278	£333.60
KLV-180-050	1800	497	15	white	1053/3593	446	17.0	£329	£394.80
KLV-180-060	1800	596	18	white	1260/4320	545	21.6	£380	£456.00
KLVC-180-030	1800	299	9	chrome	448/1529	248	10.3	£422	£506.40
KLVC-180-040	1800	398	12	chrome	597/2040	347	13.7	£517	£620.40
KLVC-180-050	1800	497	15	chrome	747/2549	446	17.0	£612	£734.40
KLVC-180-060	1800	596	18	chrome	896/3057	545	21.6	£707	£848.40

The KLV can also be installed horizontally with TBSE connections on either side.

 **Colour finish:** Standard colours from the Zehnder colour chart including matt white finish: white RAL 9016 + 25%. Colour finish and non-stock products delivery: 20-30 working days.

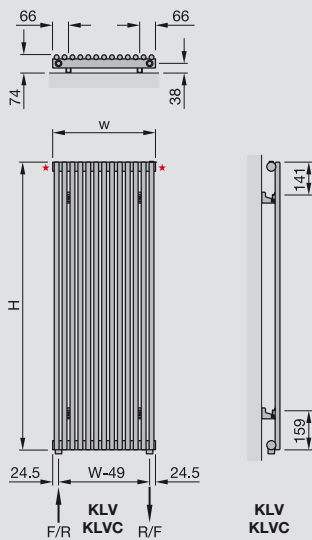
*1/8" air vent
Width excludes air vent
F = flow
R = return
H = height
W = width
Tube: Horizontal \varnothing 38mm
Tube: Vertical \varnothing 20mm
All dimensions in mm



For full  compliant technical specifications, refer to page 146
To make an approximate conversion from T=50K to T=60K multiply outputs by 1.2

Zehnder Kleo



Elegant, single or double tubed horizontal radiators with made-to-measure options. See page 100.



Valves: see page 122



Volcanic



Central Heating Model STOCK listed in black	Height mm	Width mm	Number of tubes	Finish	Output $\Delta T=50K$ Watts/btu All outputs certified to EN 442	Pipe centres	Weight kg	RRP (ex VAT)	RRP (inc 20% VAT)
Zehnder Kleo horizontal single panel									
KLH-058-100	596	1000	18	white	782/2668	962	12.4	£279	£334.80
KLH-058-120	596	1200	18	white	938/3201	1162	14.9	£305	£366.00
KLH-058-140	596	1400	18	white	1094/3735	1362	17.4	£332	£398.40
Zehnder Kleo horizontal double panel									
KLHD-058-100	596	1000	18	white	1211/4134	962	22.6	£489	£586.80
KLHD-058-120	596	1200	18	white	1453/4961	1162	27.1	£534	£640.80
KLHD-058-140	596	1400	18	white	1695/5787	1362	31.6	£580	£696.00

Made to measure sizes available (excluding chrome KLHD models)

Colour finish: Standard colours from the Zehnder colour chart including matt white finish: white RAL 9016 + 25%. Colour finish and non-stock products delivery: 20-30 working days.

*1/8" air vent
Width excludes air vent
F = flow
R = return
H = height
W = width
Tube: Horizontal \varnothing 38mm
Tube: Vertical \varnothing 20mm
All dimensions in mm

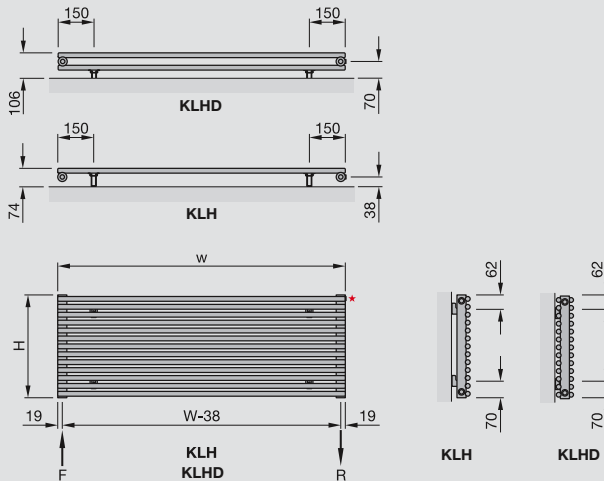

For full compliant technical specifications, refer to page 146
To make an approximate conversion from T=50K to T=60K multiply outputs by 1.2

Zehnder Kleo



Made-to-measure options with single or double tubes are available for both the horizontal or vertical Zehnder Kleo.

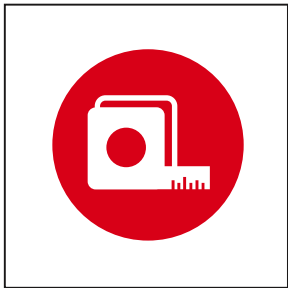

Made-to-measure



Jasmin



Standard towel bar:
see page 121



Valves: see page 122



Zehnder Kleo (KLV) vertical

Width		Model Code / Height (mm)								
(mm)	No of tubes	KLV-060 600	KLV-080 800	KLV-100 1000	KLV-120 1200	KLV-140 1400	KLV-160 1600	KLV-180 1800	KLV-200 2000	KLV-220 2200
264	8	£138	£146	£162	£170	£186	£202	£210	£218	£226
330	10	£154	£164	£184	£194	£214	£234	£244	£254	£264
396	12	£170	£182	£206	£218	£242	£266	£278	£290	£302
462	14	£186	£200	£228	£242	£270	£298	£312	£326	£340
528	16	£202	£218	£250	£266	£298	£330	£346	£362	£378
594	18	£218	£236	£272	£290	£326	£362	£380	£398	£416
660	20	£234	£254	£294	£314	£354	£394	£414	£434	£454
726	22	£250	£272	£316	£338	£382	£426	£448	£470	£492
792	24	£266	£290	£338	£362	£410	£458	£482	£506	£530
858	26	£282	£308	£360	£386	£438	£490	£516	£542	£568
924	28	£298	£326	£382	£410	£466	£522	£550	£578	£606
990	30	£314	£344	£404	£434	£494	£554	£584	£614	£644
1056	32	£330	£362	£426	£458	£522	£586	£618	£650	£682
1122	34	£346	£380	£448	£482	£550	£618	£652	£686	£720
1188	36	£362	£398	£470	£506	£578	£650	£686	£722	£758
1254	38	£378	£416	£492	£530	£606	£682	£720	£758	£796
1320	40	£394	£434	£514	£554	£634	£714	£754	£794	£834
Technical data per tube	Weight (kg)	0.5	0.6	0.7	0.8	0.9	1.0	1.2	1.3	1.4
	Output 50ΔT Watts/BTU	26/89	34/116	41/140	49/167	56/191	63/215	70/239	78/266	85/290

Output calculation example 50Δt (watts): 10 tubes x 1800 high: 10 x 70 = 700w

Zehnder Kleo (KLH) horizontal

Model Code	Height		Technical data per metre		Width (mm)								
	(mm)	No of tubes	Weight (kg)	Output 50ΔT Watts/BTU	600	800	1000	1200	1400	1600	1800	2000	2200
KLH-038	383	12	8.2	515/1757	£179	£196	£214	£231	£249	£267	£284	£302	£319
KLH-045	449	14	9.4	611/2085	£194	£214	£234	£255	£275	£295	£316	£336	£356
KLH-052	515	16	11.1	697/2378	£210	£234	£257	£280	£303	£326	£350	£373	£396
KLH-058	581	18	12.4	782/2668	£227	£253	£279	£305	£332	£358	£384	£410	£436
KLH-065	647	20	13.7	867/2958	£244	£273	£302	£331	£360	£389	£418	£447	£476
KLH-071	713	22	15.0	951/3245	£260	£292	£324	£356	£388	£420	£452	£484	£516
KLH-078	779	24	17.4	1034/3528	£277	£312	£347	£382	£417	£451	£486	£521	£556
KLH-085	845	26	18.8	1117/3811	£294	£332	£369	£407	£445	£483	£520	£558	£596
KLH-091	911	28	20.1	1200/4094	£310	£351	£392	£432	£473	£514	£554	£595	£636
KLH-098	977	30	21.4	1282/4374	£327	£371	£414	£458	£501	£545	£589	£632	£676
KLH-104	1043	32	22.8	1364/4654	£344	£390	£437	£483	£530	£576	£623	£669	£716
KLH-111	1109	34	24.1	1445/4930	£361	£410	£459	£509	£558	£607	£657	£706	£756
KLH-118	1175	36	25.4	1526/5207	£377	£430	£482	£534	£586	£639	£691	£743	£796

Output calculation example 50Δt (watts): 20 tubes x 1400 long: 1.4 x 867 = 1214w

Prices for Kleo double tubed - Double the prices above for the relevant sizes

Double panels not available in Chrome finish

Room divider kit for vertical single panel (KLV). Height adjustable 100-150mm: £75

Not available in Chrome finish

Details on intermediate sizes are available on request. Available from 7 - 90 tubes

Please refer to page 97 for vertical and page 99 for horizontal model technical diagrams

 **Colour finish:** Standard colours from the Zehnder colour chart including matt white finish: white RAL 9016 + 25%. Colour finish and non-stock products delivery: 20-30 working days.

All prices exclude VAT

For full  compliant technical specifications, refer to page 146

To make an approximate conversion from T=50K to T=60K multiply outputs by 1.2

Zehnder Stratos



The Zehnder Stratos achieves excellent heat outputs even with its compact dimensions, giving an excellent price-performance ratio.



Valves: see page 122



Central Heating Model STOCK listed in black	Height mm	Width mm	Depth	Finish	Output $\Delta T=50K$ Watts/btu All outputs certified to EN 442	Weight kg	RRP (ex VAT)	RRP (inc 20% VAT)
Zehnder Stratos with factory-fitted grille								
CS1G-015-100	153	1000	98	white	755/2578	12.6	£363	£435.60
CS1G-015-120	153	1200	98	white	906/3092	15.2	£396	£475.20
CS1G-015-140	153	1400	98	white	1057/3607	17.6	£431	£517.20
CS1G-015-150	153	1500	98	white	1134/3868	19.0	£451	£541.20
CS1G-015-160	153	1600	98	white	1209/4125	20.2	£468	£561.60
CS1G-015-200	153	2000	98	white	1511/5155	25.2	£541	£649.20
CS2G-015-100	153	1000	186	white	1331/4542	21.9	£584	£700.80
CS2G-015-120	153	1200	186	white	1598/5451	26.4	£658	£789.60
CS2G-015-140	153	1400	186	white	1864/6360	30.7	£734	£880.80
CS2G-015-150	153	1500	186	white	1997/6813	32.9	£774	£928.80
CS2G-015-160	153	1600	186	white	2130/7266	35.1	£816	£979.20
CS2G-015-200	153	2000	186	white	2663/9085	43.9	£956	£1,147.20

Zehnder Stratos without grille								
CS1-015-100	153	1000	98	white	791/2699	12.3	£343	£411.60
CS1-015-120	153	1200	98	white	949/3238	14.8	£373	£447.60
CS1-015-140	153	1400	98	white	1107/3777	17.2	£405	£486.00
CS1-015-150	153	1500	98	white	1187/4050	18.5	£421	£505.20
CS1-015-160	153	1600	98	white	1266/4319	19.7	£437	£524.40
CS1-015-200	153	2000	98	white	1582/5398	24.6	£502	£602.40
CS2-015-100	153	1000	186	white	1394/4756	21.3	£546	£655.20
CS2-015-120	153	1200	186	white	1673/5708	25.6	£612	£734.40
CS2-015-140	153	1400	186	white	1952/6660	29.8	£679	£814.80
CS2-015-150	153	1500	186	white	2091/7134	32.0	£712	£854.40
CS2-015-160	153	1600	186	white	2230/7608	34.1	£746	£895.20
CS2-015-200	153	2000	186	white	2788/9513	42.6	£878	£1,053.60

Grilles must be specified at order stage as they are not suitable for retrofit.

Colour finish: Standard colours from the Zehnder colour chart including matt white finish: white RAL 9016 + 25%. Colour finish and non-stock products delivery: 20-30 working days.

Accessories			
Model		RRP (ex VAT)	RRP (inc 20% VAT)
793102	Anti-lifting system (set of 2) for brackets	£22	£26.40

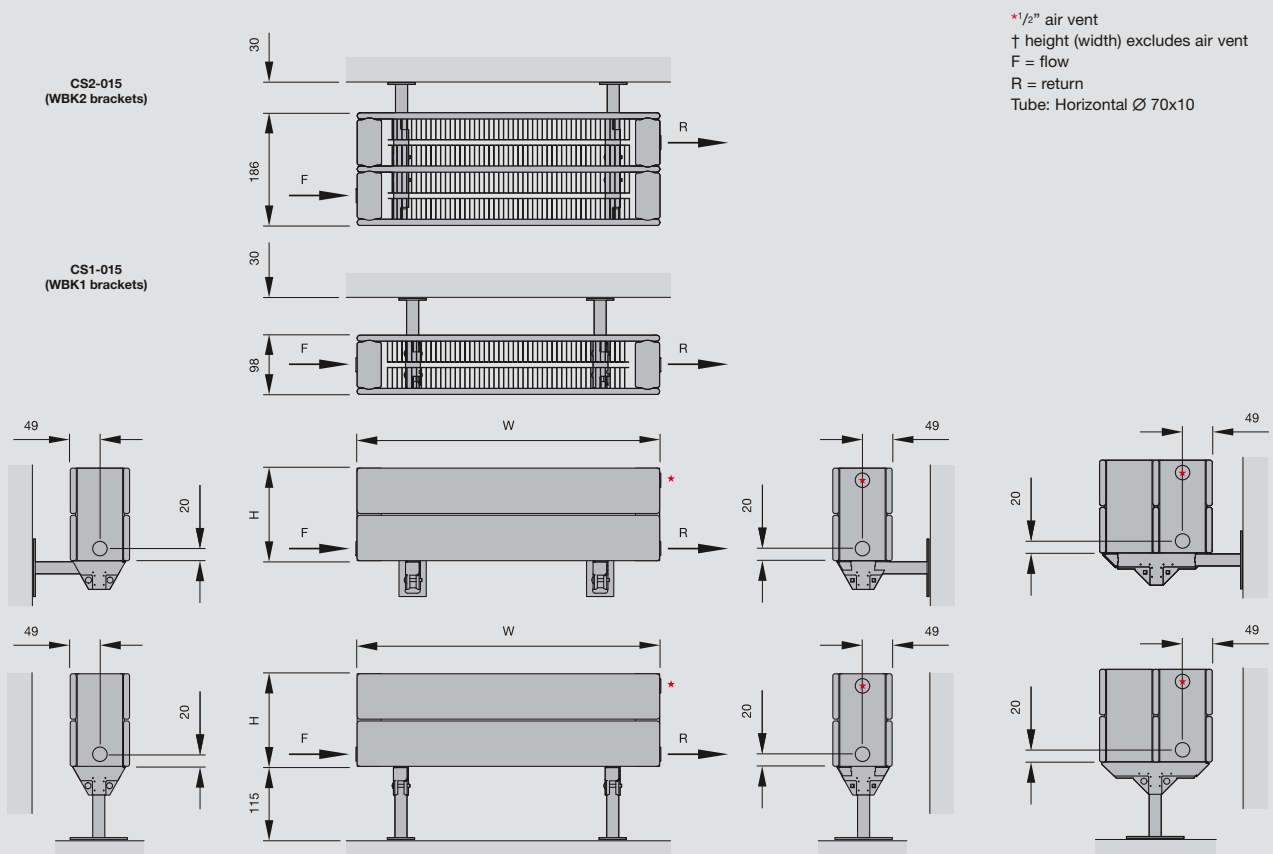

For full **CE** compliant technical specifications, refer to page 147
To make an approximate conversion from T=50K to T=60K multiply outputs by 1.2

Zehnder Lyta-S



Aluminium radiators give a fast response and comfortable heat with high thermal efficiency. Energy saving and easy to handle, resistant to corrosion and with the ability to add or remove sections according to requirements, the Lyta-S is a modern radiator in every sense. 10 year warranty



Valves: see page 122



Central Heating STOCK listed in black	Height mm	Width mm	Number of sections	Finnish	Overall Projection mm	Output $\Delta T=50K$ Watts/btu All outputs certified to EN 442	Weight kg	RRP (ex VAT)	RRP (inc 20% VAT)
 Zehnder Lyta-S horizontal									
LYSV-041-048	407	480	6	white	130	560/1911	6.6	£138	£165.60
LYSV-041-064	407	640	8	white	130	747/2549	8.8	£184	£220.80
LYSV-041-080	407	800	10	white	130	934/3187	11.0	£230	£276.00
LYSV-041-096	407	960	12	white	130	1121/3825	13.2	£276	£331.20
LYSV-041-112	407	1120	14	white	130	1308/4463	15.4	£322	£386.40
LYSV-056-048	557	480	6	white	130	746/2545	8.4	£144	£172.80
LYSV-056-064	557	640	8	white	130	995/3395	11.2	£192	£230.40
LYSV-056-080	557	800	10	white	130	1234/4210	14.0	£240	£288.00
LYSV-056-096	557	960	12	white	130	1492/5091	16.8	£288	£345.60
LYSV-056-112	557	1120	14	white	130	1740/5937	19.6	£336	£403.20
LYSV-066-048	657	480	6	white	130	855/2917	9.6	£150	£180.00
LYSV-066-064	657	640	8	white	130	1140/3890	12.8	£200	£240.00
LYSV-066-080	657	800	10	white	130	1425/4862	16.0	£250	£300.00
LYSV-066-096	657	960	12	white	130	1710/5835	19.2	£300	£360.00
LYSV-066-112	657	1120	14	white	130	1995/6807	22.4	£350	£420.00

Powder coated RAL9010 white. Colour finishes are not available.
Width excludes air vent and bushes (Additional 24mm)

The Lyta-S is a high output, low water content, die-cast aluminium radiator, sectional in manufacture, supplied with a bracket pack comprising wall fixing brackets, plugs, bushes and an air vent.

Where an intermediate sized radiator is required, additional sections can be purchased and added or removed as necessary by the installer.
Joining nipples, gaskets and an assembly tool must be purchased separately.

Lyta-S horizontal

Technical data per section

Model	Height mm	Length mm	Output 50 ΔT Watts/BTU	Weight Kg	RRP (ex VAT)	RRP (inc 20% VAT)
LYSV-041-008	407	80	93/317	1.1	£23	£27.60
LYSV-056-008	557	80	124/423	1.4	£24	£28.80
LYSV-066-008	657	80	143/488	1.6	£25	£30.00

Accessories

Model		RRP (ex VAT)	RRP (inc 20% VAT)
A36/6	Towel rail for 6 section Lyta-S. White RAL9010 (see hhh 106)	£62	£74.40
905110	Aluminium assembly tool 300	£43	£51.60
905120	Aluminium assembly tool 600	£43	£51.60
905130	Aluminium assembly tool 900	£43	£51.60
905140	Aluminium assembly tool 1200	£43	£51.60
A2/1	1 inch steel joining nipple -for use with Lyta-S	£2.20	£2.64
A10/1	Joining nipple gasket for joining the Lyta-S. White RAL 9010	£0.50	£0.60
A11/1	Gasket for end plugs for Lyta-S - Green	£1.10	£1.32
A81	Installation bush and bracket pack for Lyta-S	£20	£24.00
A80	Service assembly kit for the the Lyta-S radiator	£19	£22.80

*1/2" air vent
Width excludes air vent
F = flow
R = return
H = height
W = width
All dimensions in mm

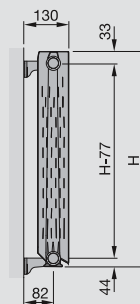
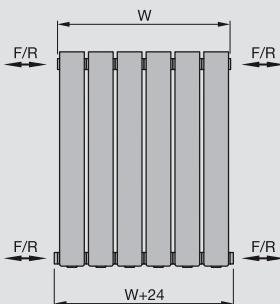

Connections: 4 x 1/2", suitable for bottom opposite ends (BOE), top bottom opposite ends (TBOE) or top bottom same end (TBSE).

For full  compliant technical specifications, refer to page 147

To make an approximate conversion from T=50K to T=60K multiply outputs by 1.2

Zehnder Lyta-T



The space-saving, fast response, economical and efficient vertical Lyta-T aluminium radiator is energy saving and easy to handle. Resistant to corrosion, sections can be added or removed to suit installation requirements. The Lyta-T has the practical option of a towel bar. 10 year warranty.



Lyta-T towel bar



Valves: see page 122



Central Heating STOCK listed in black	Height mm	Width mm	Number of sections	Finnish	Overall Projection mm	Output $\Delta T=50K$ Watts/btu All outputs certified to EN 442	Weight kg	RRP (ex VAT)	RRP (inc 20% VAT)
Zehnder Lyta-T vertical									
LYTV-097-032	966	320	4	white	127	728/2484	7.8	£196	£235.20
LYTV-097-048	966	480	6	white	127	1092/3726	11.8	£294	£352.80
LYTV-147-032	1466	320	4	white	127	1000/3412	11.2	£276	£331.20
LYTV-147-048	1466	480	6	white	127	1500/5118	16.8	£414	£496.80
LYTV-187-024	1866	240	3	white	127	900/3071	10.2	£243	£291.60
LYTV-187-032	1866	320	4	white	127	1200/4094	13.6	£324	£388.80
LYTV-187-040	1866	400	5	white	127	1500/5118	17.0	£405	£486.00
LYTV-187-048	1866	480	6	white	127	1800/6142	20.4	£486	£583.20

Powder coated RAL9010 white finish. Colour finishes are not available.
Width excludes air vent and bushes (Additional 24mm).

The Lyta-T is a high output, low water content, extruded aluminium radiator, sectional in manufacture, supplied with a bracket pack comprised of wall fixing brackets, plugs, bushes and an air vent.

Where an intermediate sized radiator is required, additional sections can be purchased and added or removed as necessary by the installer. Joining nipples, gaskets and an assembly tool must be purchased separately.

Lyta-T vertical

Technical data per section

Model	Height mm	Length mm	Output 50 ΔT Watts/BTU	Weight Kg	RRP (ex VAT)	RRP (inc 20% VAT)
LYTV-097-008	966	80	182/621	2.0	£49	£58.80
LYTV-147-008	1466	80	250/853	2.8	£69	£82.80
LYTV-187-008	1866	80	300/1024	3.4	£81	£97.20

Accessories

Model		RRP (ex VAT)	RRP (inc 20% VAT)
905110	Aluminium assembly tool 300	£43	£51.60
905120	Aluminium assembly tool 600	£43	£51.60
905130	Aluminium assembly tool 900	£43	£51.60
905140	Aluminium assembly tool 1200	£43	£51.60
A32/1	Gasket for nipples, plugs and adaptors for Lyta-T - Black	£1.10	£1.32
A33/1	1 inch steel joining nipple for Lyta-T	£2.40	£2.88
A82	Installation bush and bracket pack for Lyta-T	£20	£24.00
A36/4	Towel rail for 4 section Lyta-T. White (RAL9010)	£49	£58.80
A36/5	Towel rail for 5 section Lyta-T. White (RAL9010)	£57	£68.40
A36/6	Towel rail for 6 section Lyta-S and Lyta-T. White (RAL9010)	£62	£74.40

*1/2" air vent
Width excludes air vent
F = flow
R = return
H = height
W = width
All dimensions in mm

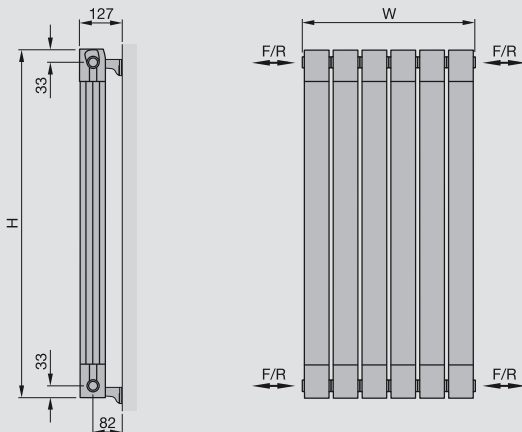

Connections: 4 x 1/2", suitable for bottom opposite ends (BOE), top bottom opposite ends (TBOE) or top bottom same end (TBSE)
Packaging includes one rubber plug/baffle (A 30/1) to be fitted in the flow position where radiators are to be installed BOE.
Valves are not included.

For full CE compliant technical specifications, refer to page 147

To make an approximate conversion from T=50K to T=60K multiply outputs by 1.2

Electric radiators

Heat at its most convenient.

Electrically heated radiators offer the ultimate in a comfortable living environment. With the multiple temperature settings of the control units, every room can be customized to requirements, maximizing efficiency, economy and comfort.

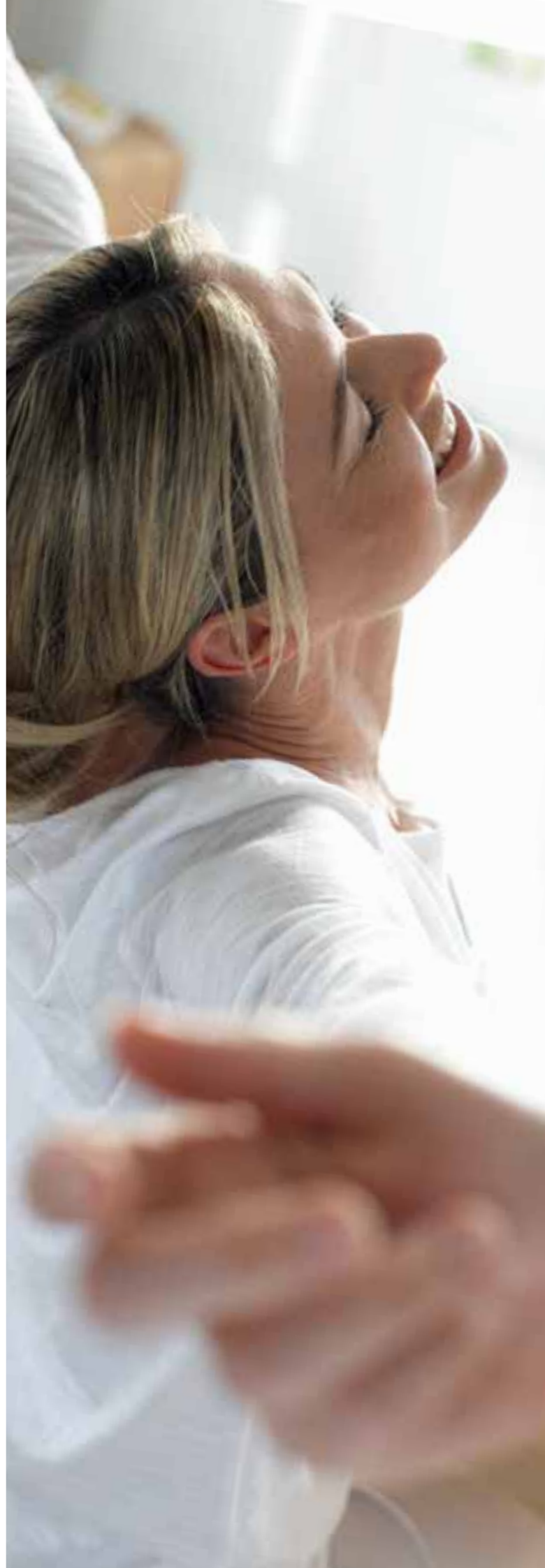



Zehnder Fare Tech



The Zehnder Fare Tech electric radiator combines beauty and brains. Manufactured from aluminium, its unique, elegantly curved shape allows comfortable radiant heat to disperse optimally throughout the room, whilst the unit's smart integrated control panel allows the room temperature to be easily set and energy consumption controlled.



CE
Volcanic

Zehnder Alura



Attractive, economical, comfortable and convenient warmth - all you could want from a radiator. The Zehnder Alura is a fast response electric radiator with a high output in relation to its small size, and is easy and economical to use. Its weight and size make it easy to install.



CE

Electric Heating Model STOCK listed in bold	Height mm	Width mm	Finish	No. of sections	With factory fitted controls, Class II IPX4 Electric Rating (Watts)	Weight kg	RRP (ex VAT)	RRP (inc 20% VAT)
⚡ Zehnder Fare Tech Electric								
TAD-057-041/F	575	407	white*	4	500	9	£301	£361.20
TAD-057-048/F	575	496	white*	5	750	11	£317	£380.40
TAD-057-064/F	575	644	white*	7	1000	14	£343	£411.60
TAD-057-080/F	575	803	white*	9	1250	17	£385	£462.00
TAD-057-088/F	575	882	white*	10	1500	18	£418	£501.60
TAD-057-128/F	575	1280	white*	15	2000	26	£506	£607.20

Projection from wall to front of radiator: 145mm max. *white (RAL 9010)

Colour finish: Standard colours from the Zehnder colour chart including matt white finish: white RAL 9010 + 25%. Colour finish and non-stock products delivery: 20-30 working days.

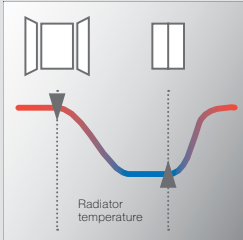

Open window detection

The integral control unit recognises if a window has been opened for an extended period and switches the radiator off. Once the window is closed, the radiator returns to normal operation.

- External temperature sensor recognises temperature changes.
- Integral thermostat reacts to sensor information.
- Radiator automatically switches off if a window is open for an extended period.
- Intelligent heating that saves energy and costs.

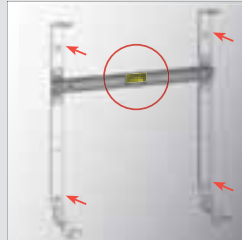

H bracket

Practical installation: The H bracket with integral spirit level makes it easy to mount the radiator level on the wall.

- Integral spirit level guarantees precise, level installation
- Designed for practical installation
- Perfect appearance: Radiator mounts close to the wall, H bracket is painted the same colour as the radiator



Smart handling

The control panel is designed as an integral part of the radiator: it is simple to operate using plus and minus keys and temperature and energy consumption are easy to read.

- Three predefined heating programs
- Control panel can be locked for security
- Operation as needed with energy consumption indicator

Electric Heating Model STOCK listed in bold	Height mm	Width mm	Finish	No. of sections	With factory fitted controls, Class II IPX4 Electric Rating (Watts)	Weight kg	RRP (ex VAT)	RRP (inc 20% VAT)
⚡ Zehnder Alura Electric								
ALE-050-036	575	356	white*	3	500	7	£246	£295.20
ALE-075-046	575	456	white*	4	750	9	£269	£322.80
ALE-100-056	575	556	white*	5	1000	11	£303	£363.60
ALE-125-076	575	756	white*	7	1250	15	£354	£424.80
ALE-150-086	575	856	white*	8	1500	17	£393	£471.60
ALE-200-116	575	1156	white*	11	2000	23	£483	£579.60

*white (RAL 9010)

Temperature Control: Electronic temperature control unit ensuring precise regulation of temperature. 6 temperature settings plus 5 mode settings. (No heat, frost protection, comfort, Eco, and auto for central programming). Suitable for IPX4 zone 1 bath and zone 2 shower.

H = height
W = width
All dimensions in mm

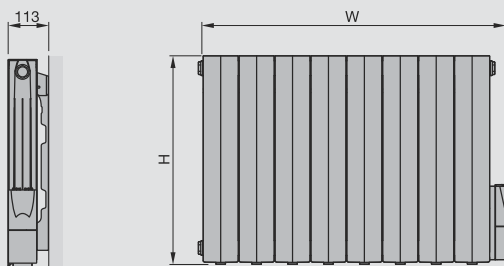

Zehnder Charleston & Charleston Plinth



The Zehnder Charleston is an electric, oil-filled multi-column radiator available in 6 sizes ideal for installation in loft conversions. The complementary Zehnder Charleston Plinth low level model is perfectly suited to conservatories and in front of low-level windows.



Zehnder Roda



Electric Zehnder Roda radiators are efficient decorative radiators, available as horizontal or vertical, perfect for all living areas.



Oyster White

Electric Heating Model STOCK listed in black	Height mm	Width mm	number of sections	Finish	Electric Immersion Rating (Watts) With factory fitted HCL Electric only Models Class II, IPX4 CE	Weight kg	RRP (ex VAT)	RRP (inc 20% VAT)
⚡ Zehnder Charleston Electric								
NZ-060-053	600	530	10	white	500	27.0	£385	£461.58
NZ-060-062	600	622	12	white	750	30.0	£456	£547.23
NZ-060-076	600	760	15	white	1000	41.0	£498	£597.77
NZ-060-089	600	898	18	white	1250	47.0	£590	£708.36
NZ-060-103	600	1036	21	white	1500	58.0	£640	£768.08
NZ-060-131	600	1312	27	white	2000	70.0	£780	£936.11
⚡ Zehnder Charleston Plinth Electric								
NZ-030-100	400	995	20	white	1000	42.4	£670	£803.42

🎨 Colour finish: Standard colours from the Zehnder colour chart including matt white finish: white RAL 9016 + 25%. Colour finish and non-stock products delivery: 20-30 working days.

Accessories			
Model		RRP (ex VAT)	RRP (inc 20% VAT)
601020	Lambswool cleaning brush	£49	£58.80
Additional Towel Rails			
966018	Charleston towel bar 368mm	£125	£150.00
966028	Charleston towel bar 918mm	£139	£166.80

H = height
W = width
All dimensions in mm

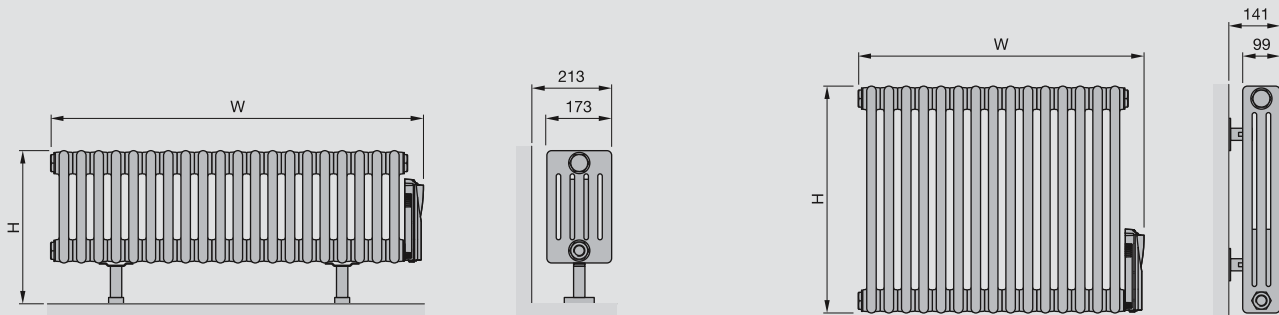

Electric Heating Model STOCK listed in black	Height mm	Width mm	Finish	With factory fitted Premium controls Class II, IPX4, IK09, NF, CE Electric Rating (Watts)	Weight kg	RRP (ex VAT)	RRP (inc 20% VAT)
⚡ Zehnder Roda Electric Vertical							
ROEV-150-040/LF	1517	375	white	750	24	£832	£998.40
ROEV-180-045/LF	1817	449	white	1000	32	£883	£1,059.60
ROEV-180-060/LF	1817	597	white	1500	40	£984	£1,180.80
⚡ Zehnder Roda Electric Horizontal							
ROEHD-040-080/LF	444	800	white	750	21.5	£703	£843.60
ROEHD-060-080/LF	592	800	white	1000	28.7	£776	£931.20
ROEHD-040-110/LF	444	1100	white	1000	28.3	£820	£984.00
ROEHD-060-110/LF	592	1100	white	1250	38.5	£891	£1,069.20
ROEHD-040-150/LF	444	1500	white	1500	37.7	£979	£1,174.80
ROEHD-060-130/LF	592	1300	white	1500	44.8	£904	£1,084.80
ROEHD-060-150/LF	592	1500	white	2000	50.4	£1,062	£1,274.40

Overall projection: 85mm Not available as dual energy

🎨 Colour finish: Standard colours from the Zehnder colour chart including matt white finish: white RAL 9016 + 25%. Colour finish and non-stock products delivery: 20-30 working days.

Accessories: Please refer to accessories section page 121.

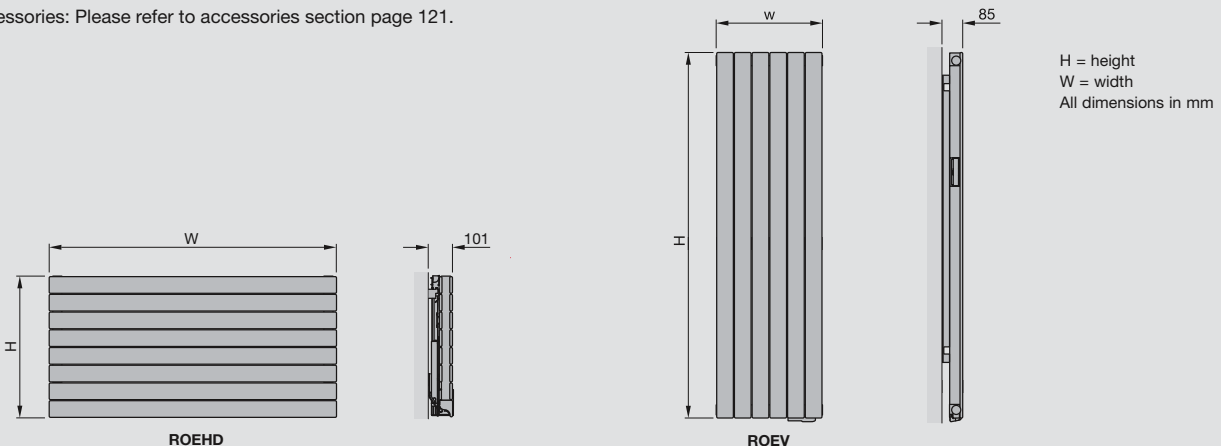

Extractor Fans

Silence, style and simplicity.

Condensation and mould are not new phenomena and the need to safeguard dwellings against them has not diminished. In fact, with improved heating systems, insulation and double glazing, homes are becoming more and more sealed, however, homes need air to 'breathe' and that air needs to be of good quality. Zehnder offers a choice of wall and ceiling extraction fans to blend with indoor decors which also incorporate uniquely quiet and low consumption options for the ultimate solution in single point ventilation.





1

Energy efficiency

The ZLE100 low energy Adaptive fan only consumes between 1.6 and 8.9 watts per hour depending on speed setting, and costing under 50p a year to operate based on 1½ hours daily use.



2

Health

Airborne particles are always floating around our homes, including those found in man-made furnishings and cleaning products plus moisture is continually created through bathing and washing. Zehnder extract fans have been designed to eliminate condensation and improve the general air quality within the home by extracting stale air from the wet rooms where many of the major pollutants can build up. Using extraction fans helps to provide a comfortable environment within the home by improving the indoor air quality.



3

Silence

A major concern for home owners is the level of noise produced from standard ventilation, particularly in the bathroom where relaxation and a sanctuary atmosphere is so important. Taking account of this, Zehnder offers a range of 'Silent' fans operating at typically 70% less noise than standard bathroom fans; the ZSR100 fan is 26 dB (A).



Leaves Rustling
10 dB (A)



Whispering
20 dB (A)



Talking
40 - 60 dB (A)



4

Style

Inspired by modern trends and a popular desire for matching accessories, Zehnder decorative fans use materials, finishes and shapes that blend stylishly with surrounding decor. The range of fans has been created to complement current bathroom and kitchen design, comprising models that incorporate lighting, high quality materials, discreet low profile designs and decorative front covers with a choice of easy to change, central inserts, transforming ventilation into a design feature.



5

Simplicity

Zehnder extraction fans are simple to fit, control and maintain, providing the perfect solution for refurbishment projects where central systems can be difficult to install. Zehnder offers a comprehensive range of accessories to suit both wall and ceiling applications.

Zehnder Silent Wall & Ceiling Fans 100Mm

The range of Zehnder Silent fans offer “whisper-quiet” operation – typically a minimum of 70% less noise than standard fans. This range has been developed in response to customers who want high performance ventilation without nuisance noise. 3 year warranty.



Zehnder Adaptive Wall & Ceiling Fans 100Mm

The economical low-energy Zehnder Adaptive fan offers the latest in intermittent technology - adaptive extraction - with 6 pre-set speeds to choose from for different installation applications, generating the required extraction rate from the room. 3 year warranty.



Operating information:

100mm fan suitable for walls and ducted ceilings with a supplied choice of 3 fascia options

Zehnder Silent Basic wall fan:

- Single speed
- Operation by light switch or remote

Zehnder Silent Timer fan:

- Single speed, 230v
- Operation by light switch or remote switch
- Adjustable over-run timer (2-30mins) factory set at 15 minutes. When wired into room light or remote switch the fan will operate whilst the light is on and, when switched off, will run on over-run timer for the pre-set over-run period.

Zehnder Silent Humidistat fan:

- Single speed, 230v
- Automatic operation by the integrated humidistat sensor with optional manual override via remote switch
- Over-run timer cuts in once desired humidity has been reached to prevent fan 'hunting' on and off. Adjustable over-run timer (2-30mins)

Model STOCK listed in black	Features	RRP (ex VAT)	RRP (inc 20% VAT)
 Fascia options 1, 2 and 3	Basic Silent fan ZSR100B10A 100mm basic silent fan. Remote operation	£59	£70.80
	Timer Silent fan ZSR100TR11A 100mm timer silent fan. Remote operation	£71	£85.20
	Humidistat Silent fan ZSR100HTR12A 100mm humidistat silent fan. Remote operation	£120	£144.00

Product	Application	Airflow m ³ /h in free air	Airflow l/s in free air (BS848 Pt 1)	Sound pressure level @ 3m dB(A)	Energy Consumption (W)	IP Rating	Operation
100mm Basic Silent wall & ceiling fan	W.C. Bathroom	95	26	26.7	13	IPX4	single speed
100mm Timer Silent wall & ceiling fan	W.C. Bathroom	95	26	26.7	16	IPX4	single speed
100mm Humidistat Silent wall & ceiling fan	Bathroom	95	26	26.7	16	IPX4	single speed

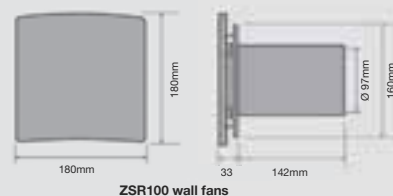

ZSR100 wall fans

Operating information:

100mm fan suitable for through wall and ducted ceiling/wall installation



The speed of the fan is set by the installer according to the size and use of the room, thus avoiding over or under ventilation.

Zehnder Adaptive fan with "smart" timer technology and pull cord option.

The length of time of the fan over-run is based on occupancy duration, up to a maximum run-time of 15 minutes, reducing heat loss and energy usage.

Zehnder Adaptive fan with "smart" humidistat and timer technology and pull cord option.

The fan knows the normal humidity level and only activates when spikes occur, providing the right amount of ventilation when required, unlike fans with a generic point that respond to high ambient humidity on a summer's day and particularly in the middle of the night.

Model STOCK listed in black	Features	RRP (ex VAT)	RRP (inc 20% VAT)
 Adaptive fan	Adaptive fan ZLE100TA 100mm low energy Adaptive fan with "smart" timer technology and pull cord.	£77	£92.40
	Adaptive fan ZLE100HTA 100mm low energy Adaptive fan with "smart" humidistat and timer technology and pull cord.	£124	£148.80

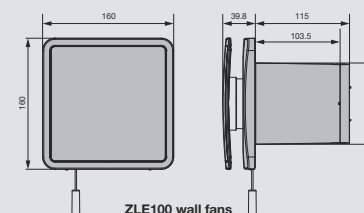

Product	Airflow m ³ /h in free air		Airflow l/s in free air (BS848 Pt 1)		Sound pressure level @ 3m dB(A)		Energy Consumption (W)		IP Rating	Operation
	Min	Max	Min	Max	Min	Max	Min	Max		
100mm Adaptive wall & ceiling fan	49	111.6	13.6	31	25	45	1.6	8.9	IPX4	6 speed





ZLE100 wall fans

Accessories	RRP (ex VAT)	RRP (inc 20% VAT)
-------------	--------------	-------------------

Wall fan accessories

 ZED1A Plastic wall inner with integral screw-fixing channels	£7	£8.40
 ZEG1WA Fixed blade louvered external wall vent in white	£4	£4.80
	ZEG1BA Fixed blade louvered external wall vent in brown	£4
 ZFF100W ZFF100B Fast fix wall duct system with external grill available in white (W) or brown (B)	£11	£13.20

Ceiling fan accessories

 ZGFP4.3A Flexiduct 3m x Ø100mm (required for ceiling fitting)	£9	£10.80
 ZGG42WA 100mm External grille with spigot in white	£5	£6.00
	ZGG42BA 100mm External grille with spigot in brown	£5

Zehnder Silent Shower Fan Kits 100Mm

Silent fans are 70% quieter than standard axial fans when operating. Supplied as shower kits with or without a light and with a 3 year warranty.



Zehnder Halo Designer Shower Fan & Light Kit 125Mm

Today's luxurious showers and bathrooms call for high performance and high design. The Zehnder Halo is a ceiling extractor fan supplied as a kit with an integrated light and a 3 year warranty.





Operating information:

Zehnder Silent Timer fan:

- Single speed, 230v
- Operation by light switch or remote switch

Zehnder Silent Timer ceiling fan with light:

- Single speed, 230v
- Operation by light switch or remote switch

Model STOCK listed in black	Features	RRP (ex VAT)	RRP (inc 20% VAT)	
100mm fan suitable for ducted ceilings				
	ZSR100TSKA	Zehnder Silent Timer shower kit Kit includes 100mm induct fan with adjustable timer, 90° bend, 3 metres of Flexiduct, 4 fixing clips, outlet grille and fixing screws.	£128	£153.60
	ZSR100LTSKA	Zehnder Silent Timer shower kit & light Kit comprising 100mm induct fan with adjustable timer, internal grille with SELV (Safety Extra Low Voltage) 12V light unit LV light transformer. 90° bend, 3 metres of Flexiduct, 4 fixing clips, outlet grille and fixing screws, white & chrome bezels.	£141	£169.20

Product	Application	Airflow m ³ h in free air	Airflow l/s in free air (BS848 Pt 1)	Sound pressure level @ 3m dB(A)	Energy Consumption (W)	IP Rating	Operation
100mm Silent Timer shower kit	Bathroom	110	31	20	16	IPX4	single speed
100mm Silent Timer shower kit & light	Bathroom	110	31	20	fan 16W, 12V lamp rated at 20W	IPX4	single speed



ZSR100TSKA

ZSR100LTSKA

Zehnder Silent 100mm Induct Fans

Operating information:

Zehnder Halo Timer ceiling fan with light:

- Single speed, 230v
- Operation by light switch or remote switch
- Adjustable over-run timer (2-30mins) factory set at 15 minutes. When wired into room light or remote switch the fan will operate whilst the light is on and, when switched off, will run on over-run timer for the pre-set over-run period.
- Suitable for internal bathrooms, WCs or for installation above showers

Model STOCK listed in black	Features	RRP (ex VAT)	RRP (inc 20% VAT)	
125mm ceiling fan suitable for ducted ceilings				
	ZHC115TBKA	Zehnder Halo timer ceiling fan shower kit with light Kit comprising 125mm induct fan with adjustable timer, internal grille with SELV (Safety Extra Low Voltage) 12V light unit LV light transformer. 90° bend, 3 metres of Flexiduct, 4 fixing clips, outlet grille and fixing screws, white & chrome bezels.	£103	£123.60

Product	Application	Airflow m ³ h in free air	Airflow l/s in free air (BS848 Pt 1)	Sound pressure level @ 3m dB(A)	Energy Consumption (W)	IP Rating	Operation
125mm Silent Timer ceiling fan with light	Bathroom	200	56	31	fan 20W, 12V lamp rated at 20W	IPX4	single speed

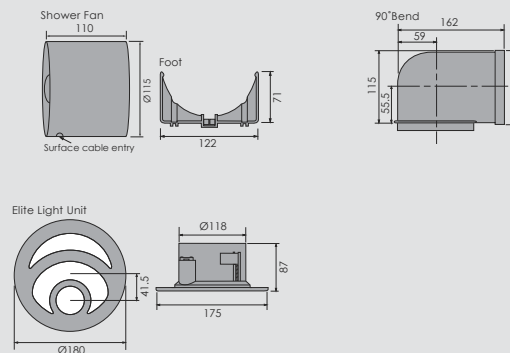

ZHC115TBKA

Accessories,
valves, dual energy
and electric
products

Maximise the potential.

Well matched valves and accessories enhance the aesthetics of radiators and towel rails, while a dual energy installation in your bathroom guarantees luxury and comfort throughout the year.



Zehnder accessories

Model	Overall length mm	Centres mm	Depth mm	Suitable for	Min. n° vertical tubes required	Fixing	RRP ex VAT	RRP inc VAT
-------	-------------------	------------	----------	--------------	---------------------------------	--------	------------	-------------

Zehnder Taurus towel bar - Chrome

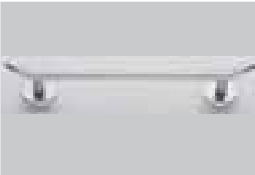
	471008	399	297	67	Kleo, Klaro, Sfera, Yucca	Kleo: 11	Non magnetic	£85	£102.00
	471018	432	330			Kleo: 12		£97	£116.40
	471028	531	429			Kleo: 15		£109	£130.80
	471108	399	297		Roda Spa, Roda, Ax Spa	Roda: 6	Magnetic	£149	£178.80
	471118	432	330			Roda: 7		£160	£192.00
	471128	531	429			Roda: 8		£171	£205.20

Standard towel bar - Chrome

	461138	300	264	67	Kleo	Kleo: 10	Non magnetic	£54	£64.80	
	462138	440	396			Kleo: 14		£56	£67.20	
	463138	540	495			Kleo: 17		£58	£69.60	
	461168	340	296		Roda (excl ROHL) & Roda Spa ranges	Roda: 6		Magnetic	£54	£64.80
	462168	410	370			Roda: 7			£56	£67.20
	463168	480	444			Roda: 8			£58	£69.60

Zehnder Taurus double hook - Chrome

	470318	100	n/a	67	Kleo, Klaro, Sfera, Yucca	n/a	Non magnetic	£50	£60.00
	470328				Roda Spa, Roda, Ax Spa		Magnetic	£54	£64.80

Towel Ring

	455138	200	n/a	65	Sfera, Kleo	n/a	Non magnetic	£110	£132.00
	455118				Ax, Ax Spa				
	455168				Roda Spa, Roda (excl ROHL)				

Bay towel bar

	Brushed st steel TBAR-9517	290	n/a	60	Bay	5	Non magnetic	£71	£85.20
	Polished st steel TBAR-9516							£97	£116.40

Charleston towel bar

	966018	368	n/a	45	Charleston Charleston Bar can be cut to length	9 max	Non magnetic	£125	£150.00
	966028	918				18 max		£139	£166.80

Metropolitan towel bar (not suitable for MEV models)

	468038	400	n/a	40	Metropolitan	n/a	Non magnetic	£89	£106.80
	468048	500						£91	£109.20
	468058	600						£94	£112.80

Metropolitan hook - chrome x 2 (not suitable for MEV models)

	480438	35	n/a	35	Metropolitan	n/a	Non magnetic	£40	£48.00
---	--------	----	-----	----	--------------	-----	--------------	-----	--------

Lambswool brush

	601020	n/a	n/a	n/a	Charleston Range	n/a	n/a	£49	£58.80
---	--------	-----	-----	-----	------------------	-----	-----	-----	--------

Pipe and base plate accessory kit 2 x 300mm Ø15mm pipe plus 2 cover plates, suitable for most models except those with 50mm pipe centres

	PIPEKIT-9016	white	£23	£27.60
	PIPEKIT-CR	chrome		
	PIPEKIT-BS	brushed steel		
	PIPEKIT-AG	antique gold		

Optional Simple immersion heater cover

	SHECZ-CR	chrome finish	£45	£54.00
---	----------	---------------	-----	--------

Pipework from the wall	Manual Valve sets							Thermostatic Valve sets		
	VAL-SET-1-CR	VAL-SET-2-CR	VAL-SET-5-BS	VAL-SET-5-CR	VAL-SET-6-BS	VAL-SET-6-CR	VAL-SET-8-CR	VAL-SET-10-CR	VAL-SET-11-CR	VAL-SET-9-CR
Ax	£38	£54	x	x	x	x	£98	£165	£165	£123
Ax Spa	£38	£54	x	£187	x	£192	£98	£165	£165	£123
Balmoral	£38	£54	x	x	x	x	£98	£165	£165	£123
Bay	£38	£54	£195	£187	£200	£192	x	£165	£165	£123
Buckingham	£38	£54	x	x	x	x	£98	£165	£165	£123
Charleston	£38	£54	x	x	x	x	£98	£165	£165	£123
Cove	£38	£54	£195	£187	£200	£192	x	£165	£165	£123
Keel range	£38	£54	£195	£187	£200	£192	x	£165	£165	£123
Kensington	£38	£54	x	x	x	x	£98	£165	£165	£123
Klaro	£38	£54	x	x	x	x	£98	£165	£165	£123
Kleo	£38	£54	x	x	x	x	x	£165*	£165*	£123
Lyta-S (horizontal)	£38	£54	x	x	x	x	£98	£165	£165	£123
Lyta-T (vertical)	£38	£54	x	x	x	x	£98	£165	£165	£123
Metropolitan	£38	£54	£195	£187	£200	£192	x	£165	£165	£123
Metropolitan Spa	£38	£54	£195	£187	£200	£192	x	£165	£165	£123
Nobis	£38	£54	x	x	x	x	x	£165	£165	£123
Osbourne	£38	£54	x	x	x	x	£98	£165	£165	£123
Quaro Spa	£38	£54	£195	£187	£200	£192	£98	£165	£165	£123
Roda	£38	£54	x	x	x	x	£98	£165*	£165*	£123
Roda Mirror	£38	£54	x	x	x	x	£98	£165	£165	£123
Roda Spa	£38	£54	x	x	x	x	£98	£165	£165	£123
Roda Spa Asym	£38	£54	x	x	x	x	£98	£165	£165	£123
Sfera Bow	£38	£54	x	x	x	x	£98	£165	£165	£123
Stellar	£38	£54	£195	£187	£200	£192	£98	£165	£165	£123
Stellar Spa	£38	£54	£195	£187	£200	£192	£98	£165	£165	£123
Stratos	£38	£54	£195	£187	£200	£192	x	£165	£165	£123
Subway	£38	£54	£195	£187	£200	£192	£98	£165	£165	£123
Vitalo Bar	£38	£54	£195	£187	£200	£192	x	£165	£165	£123
Yucca range	£38	£54	x	x	x	x	x	£165	£165	£123

*Not suitable for single panel models.

The thermostatic valves are not bi-directional and must be installed on the flow connection position.

Please note:

All valves are ex-stock

ALL prices shown here EXCLUDE VAT

Manual Valves

VAL-SET-1-CR

Modern angled radiator valve set chrome plated.

Centre of valve to point of connection: 38mm

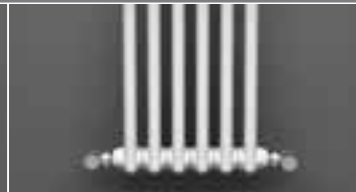
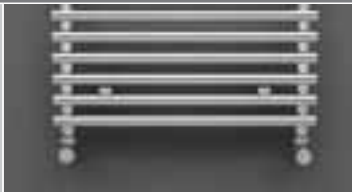

VAL-SET-2-CR

Contemporary double angled radiator valve set chrome plated.

Centre of valve to point of connection: 37mm



VAL-SET-5-BS

Square head angled valve set brushed steel.

VAL-SET-5-CR

Square head angled valve set chrome plated.

Centre of valve to point of connection: 48mm



VAL-SET-6-BS

Square head double angled valve set brushed steel.

VAL-SET-6-CR

Square head double angled valve set chrome plated.

Centre of valve to point of connection: 48mm



VAL-SET-8-CR

Traditional valve set chrome plated.

Centre of valve to point of connection: 37mm

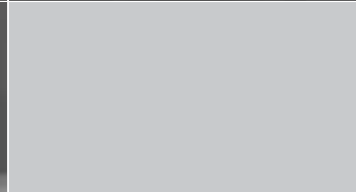

Thermostatic Valves

VAL-SET-10-CR

Thermostatic double angled valve set chrome plated.

Centre of valve to point of connection: 44mm



VAL-SET-11-CR

Thermostatic double angled valve set chrome plated.

Centre of valve to point of connection: 44mm



VAL-SET-9-CR

Thermostatic angled valve set chrome plated.

Centre of valve to point of connection: 40mm



Speciality Valves pipe work from the wall

These valves are suitable for the Yucca radiator on both central heating and dual energy installations. A TRV head, nut and olive set are also required. DE Pack also needs to be ordered separately.

All prices shown are ex vat

TRV Head		Central heating & DE		
white	chrome			
1011061	1011069			
£19	£21			
1/2" nut and olive. Set of 2.				
1016863		with short cover plate (adds 140mm to height of radiator)		
£11		white	chrome	colour
		976021	976028	976029
		£175	£244	£201

Pipework from the floor	Manual Valve sets							Thermostatic Valve sets					
	VAL-SET-3-CR	VAL-SET-1-CR	VAL-SET-7-BS	VAL-SET-7-CR	VAL-SET-5-BS	VAL-SET-5-CR	VAL-SET-8-CR	VAL-SET-12-CR	VAL-SET-9-CR	VAL-SET-16-CR	VAL-SET-16-BR	VAL-SET-17-BR	VAL-SET-17-VO
Ax	£38	x	x	x	x	x	x	£123	x	x	x	x	x
Ax Spa	£38	x	x	£187	x	x	x	£123	x	x	x	x	x
Balmoral	x	£38	x	x	x	x	£98	x	£123	£176	£176	£143	£131
Bay	£38	£38	£195	£187	£195	£187	x	£123	£123	x	x	£143	£131
Buckingham	£38	x	x	x	x	x	x	x	x	x	x	x	x
Charleston	x	£38	x	x	x	x	£98	x	£123	£176	£176	£143	£131
Cove	£38	x	£195	£187	x	x	x	£123	x	x	x	x	x
Keel range	£38	x	£195	£187	x	x	x	£123	x	x	x	x	x
Kensington	x	£38	x	x	x	x	£98	x	£123	£176	£176	£143	£131
Klaro	£38	x	x	x	x	x	x	£123	x	x	x	x	x
Kleo	£38	x	x	x	x	x	x	£123	x	x	x	x	x
Lyta-S (horizontal)	x	£38	x	x	x	x	x	x	£123	£176	£176	x	x
Lyta-T (vertical)	x	£38	x	x	x	x	x	x	£123	£176	£176	x	x
Metropolitan	£38	x	£195	£187	x	x	x	£123	x	x	x	x	x
Metropolitan Spa	£38	x	£195	£187	x	x	x	£123	x	x	x	x	x
Nobis	£38	x	x	x	x	x	x	£123	x	x	x	x	x
Osbourne	x	£38	x	x	x	x	£98	x	x	£176	£176	x	x
Quaro Spa	£38	x	£195	£187	x	x	x	£123	x	x	x	x	x
Roda	£38	x	x	x	x	x	x	£123	x	x	x	x	x
Roda Mirror	£38	x	x	x	x	x	x	£123	x	x	x	x	x
Roda Spa Asym ROFR	£38	x	x	x	x	x	x	£123	x	x	x	x	x
Roda Spa Asym ROFL	£38	x	x	x	x	x	x	£123	x	x	x	x	x
Sfera Bow	£38	x	x	x	x	x	x	£123	x	x	x	x	x
Stellar	£38	x	£195	£187	x	x	x	£123	x	x	x	x	x
Stellar Spa	£38	x	£195	£187	x	x	x	£123	x	x	x	x	x
Stratos	x	£38	x	x	£195	£195	x	x	£123	£176	£176	£143	£131
Subway	£38	x	£195	£187	x	x	x	£123	x	x	x	x	x
Vitalo Bar	£38	x	£195	£187	x	x	x	£123	x	x	x	x	x
Yucca range	£38	x	x	x	x	x	x	£123	x	x	x	x	x

The thermostatic valves are not bi-directional and must be installed on the flow connection position.

Please note:

All valves are ex-stock

ALL prices shown here EXCLUDE VAT

Manual Valves

VAL-SET-3-CR

Stylish straight radiator valve set chrome plated.

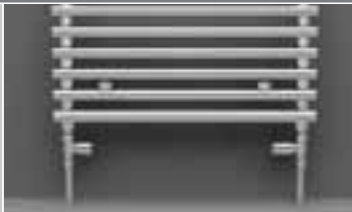

VAL-SET-1-CR

Modern angled radiator valve set chrome plated.

Centre of valve to point of connection: 38mm



VAL-SET-7-BS

Square head straight valve set brushed steel.

VAL-SET-7-CR

Square head straight valve set chrome plated.



VAL-SET-5-BS

Square head angled valve set brushed steel.

VAL-SET-5-CR

Square head angled valve set chrome plated.

Centre of valve to point of connection: 48mm

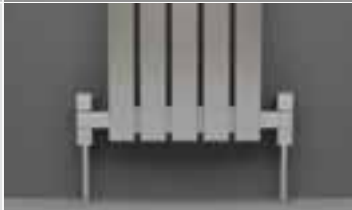

VAL-SET-8-CR

Traditional valve set chrome plated.

Centre of valve to point of connection: 37mm



Thermostatic Valves

VAL-SET-12-CR

Thermostatic straight valve set chrome plated.

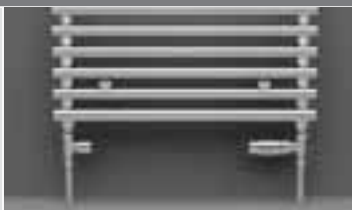

VAL-SET-9-CR

Thermostatic angled valve set chrome plated.

Centre of valve to point of connection: 40mm

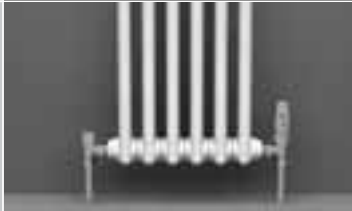

VAL-SET-16-CR

Aston angled thermostatic valve set chrome plated.

VAL-SET-16-BR

Aston angled thermostatic valve set brass plated.

Centre of valve to point of connection: 45mm

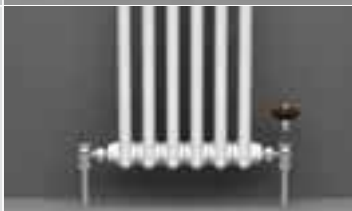

VAL-SET-17-BR

Antique design angled thermostatic valve set brass finish.







VAL-SET-17-VO

Antique design angled thermostatic valve set volcanic finish.

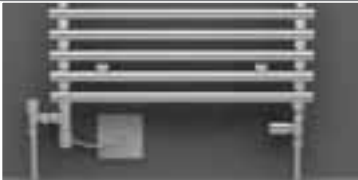
Centre of valve to point of connection: 44mm

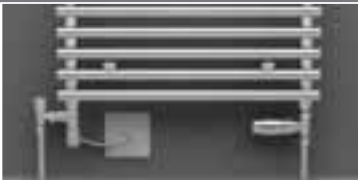

Dual energy installations The electrical element must always be fitted to the return side of the radiator Prices EXCLUDE VAT	Pipe work from the floor				Pipe work from the wall											
	Manual Valve sets		Thermostatic Valve sets		Manual Valve sets						Thermostatic Valve sets					
	VAL-SET-4-CR	VAL-SET-3-CR	VAL-SET-13-CR	VAL-SET-12-CR	VAL-SET-1-CR	VAL-SET-2-CR	VAL-SET-18-CR	VAL-SET-19-CR	VAL-SET-5-BS	VAL-SET-5-CR	VAL-SET-14-CR	VAL-SET-15-CR	VAL-SET-10-CR	VAL-SET-11-CR	VAL-SET-20-CR	VAL-SET-21-CR
Ax Spa	£38	x	£123	x	£38	x	£118	x	x	x	x	£137	x	x	£163	x
Cove	£38	x	£123	x	£38	x	£118	£118	£195	£187	£137	£137	x	x	£163	£163
Keel range	£38	x	£123	x	£38	x	£118	£118	£195	£187	£137	£137	x	x	£163	£163
Klaro	£38	x	£123	x	£38	x	£118	£118	x	x	£137	£137	x	x	£163	£163
Metropolitan Spa (METM)	x	£38	x	£123	£38	£54	£118	£118	x	£187	x	x	£165	£165	£163	£163
Quaro Spa	x	£38	x	£123	£38	£54	£118	£118	x	£187	x	x	£165	£165	£163	£163
Roda	£38	x	£123	x	£38	x	£118	£118	x	x	£137	£137	x	x	£163	£163
Roda Spa	£38	x	£123	x	£38	x	£118	£118	x	x	£137	£137	x	x	£163	£163
Roda Spa Asym ROFR	£38	x	£123	x	£38	x	£118	£118	x	x	£137	x	x	x	£163	£163
Roda Spa Asym ROFL	£38	x	£123	x	£38	x	£118	£118	x	x	x	£137	x	x	£163	£163
Sfera Bow	£38	x	£123	x	£38	x	£118	x	x	x	£137	x	x	x	£163	x
Stellar	£38	x	£123	x	£38	x	£118	£118	x	£187	£137	£137	x	x	£163	£163
Stellar Spa	£38	x	£123	x	£38	x	£118	£118	x	£187	£137	£137	x	x	£163	£163
Subway	x	£38	x	£123	£38	£54	£118	£118	x	£187	x	x	£165	£165	£163	£163
Yucca range	£38	x	£123	x	£38	x	£118	£118	x	x	£137	£137	x	x	£163	£163

Manual Valves pipe work from the floor		
<p>VAL-SET-4-CR Mixed dual energy radiator valve set chrome plated.</p>		
<p>VAL-SET-3-CR Stylish straight radiator valve set chrome plated.</p>		
Thermostatic Valves pipe work from the floor		
<p>VAL-SET-13-CR Thermostatic mixed valve set chrome plated.</p>		
<p>VAL-SET-12-CR Thermostatic straight valve set chrome plated.</p>		

Please note: All valves are ex-stock ALL prices shown here EXCLUDE VAT

VAL-SET-1-CR
Modern angled radiator valve set chrome plated.

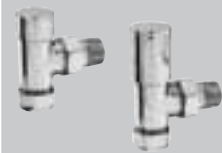

VAL-SET-2-CR
Contemporary double angled radiator valve set chrome plated.

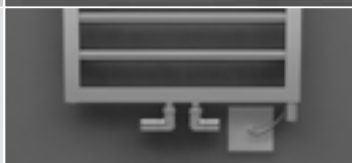

VAL-SET-18-CR
Dual fuel right hand flow valve set chrome plated.



VAL-SET-19-CR
Dual fuel left hand flow valve set chrome plated.

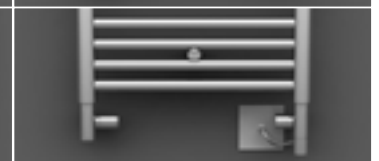

VAL-SET-5-BS
Square head angled valve set brushed steel.



VAL-SET-5-CR
Square head angled valve set chrome plated.

Thermostatic Valves pipe work from the wall

VAL-SET-14-CR
Thermostatic double angled mixed valve set chrome plated.



VAL-SET-15-CR
Thermostatic double angled mixed valve set chrome plated.

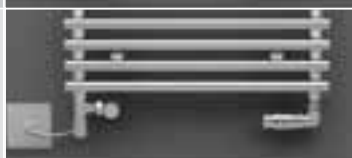

VAL-SET-10-CR
Thermostatic double angled valve set chrome plated.



VAL-SET-11-CR
Thermostatic double angled valve set chrome plated.



VAL-SET-20-CR
Thermostatic dual fuel right hand flow valve set chrome plated.



VAL-SET-21-CR
Thermostatic dual fuel left hand flow valve set chrome plated.

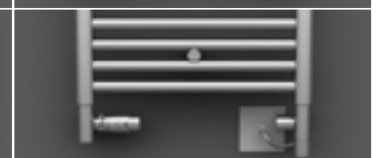

Optional Simple immersion heater cover

SHECZ-CR
chrome finish
£45.00 plus vat

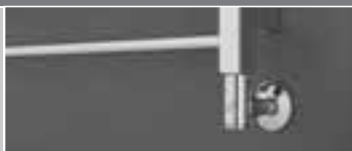

Zehnder dual energy and electric elements

Zehnder's range of electric radiators, with their factory-fitted electric elements, give economical and efficient heating wherever required.

Dual energy towel drying radiators continue to offer warmth and comfort throughout the home during summer months when the central heating system is not in use.

To switch heating operations:

For summer use:

- Switch off the central heating
- Vent the radiator to ensure there isn't any air present
- Close the flow valve (only)
- Activate the immersion heater as required

For winter use:

- De-activate the immersion heater
- Open the flow valve

The immersion heater should be fitted on the return side of the radiator

Simultaneous use of the electrical element and the central heating should be avoided as this will shorten the life of the element and invalidate the warranty.

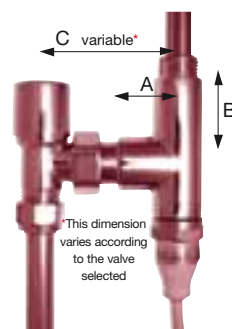

Dimensions (mm)		
A	B	C
DBM short t-piece with Chromax valve		
22	17	65
DE-Pack short t-piece with Chromax valve		
22	17	65

We recommend that all electrical work be undertaken in accordance with current I.E.E wiring regulations. If in doubt of zoning requirements, we recommend that a 30mA R.C.D is installed.

Zehnder dual energy heating options			
Model	DE pack	DBM	Safir
Ax Spa	✓	✓	
Cove	✓	✓	
Keel Range	✓		
Klaro	✓	✓	
Metropolitan Spa			✓
Roda Spa	✓	✓	
Roda Spa Asymmetrical	✓	✓	
Sfera Bow	✓	✓	
Stellar	✓	✓	
Stellar Spa	✓	✓	
Subway	✓	✓	
Yucca Range	✓	✓*	

✓ Self fit
 ✓ Factory fitted dual energy immersion heater - see page 33 for details
 * DBM not suitable for use with the Yucca Valve

DE Pack (Class I IPX5 - Zone 1 and 2) Electrical element and chromium plated t-piece for element and radiator valve connection (no controls).	Model	Watts	Length (mm)	RRP (ex VAT)	RRP (inc VAT)
	DE Pack 100	100	304	£123	£147.60
	DE Pack 150	150	304		
	DE Pack 200	200	339		
	DE Pack 300	300	377		
	DE Pack 400	400	416		
	DE Pack 500	500	496		
	DE Pack 600	600	581		
	DE Pack 700	700	753		
	DE Pack 900	900	900		

DBM Pack (Class II IPX4 - Zone 1 and 2) Manual and programmable operations, 2 temperature settings, 2 hour programmable timer. Equipped with a thermal fuse. Chromium plated t-piece included with dual energy version.	Model	Watts	Finish	RRP (ex VAT)	RRP (inc VAT)
	857531	150	white	£175	£210.00
	857541	200			
	857211	300			
	857251	500			
	857221	600			
	857261	750	chrome	£200	£240.00
	857231	900			
	857288	150			
	857278	200			
	857218	300			
	857258	500			
	857228	600			
	857268	750			
	857238	900			





Zehnder electric energy factory-fitted elements							
Model	Non-programmable	Programmable*				Programmable with infra red controls	
		TH-RAD	Z23180	DBM	Memopro	Safir**	Irvar
Alura			✓				
Ax Spa	✓			✓			
Balmoral	✓						
Buckingham	✓						
Charleston		✓					
Klaro	✓						
Metropolitan Spa						✓	
Osbourne	✓						
Quaro Spa						✓	
Roda Spa	✓			✓			
Roda Spa Asymmetrical					✓		
Sfera Bow	✓***			✓			
Subway	✓***					✓	
Yucca range							✓

* Programmable to varying levels of functionality.

** The shape of the Safir immersion unit differs according to the radiator.

*** Subway and Sfera simple immersion heater housed in Safir casing.

Factory fitted options

	<p>Memopro (Class II IPX4 - Zone 1 bath and Zone 2 shower) Energy savings electronic room temperature control with programmable or manual temperature boost for towel drying. (Image shows unit with hinged cover in the open position).</p>
	<p>Safir (Class II IPX4 - Zone 1 bath and Zone 2 shower) Programmable infrared electronic regulation system with constant, economy, boost and automatic settings. Equipped with a thermal fuse. (The shape of the Safir receiver differs to suit the radiator design. The image shows the Infra red control unit).</p>
	<p>Irvar-0 (Class I IPX5 - Zone 1) Remote infrared temperature and programme control 35°C to 70°C. Equipped with a thermal fuse. (Unit extends 150mm below radiator).</p>
	<p>TH-RAD (Class II IPX4 Zone 1 bath and Zone 2 shower) 9 heat settings plus 5 mode settings. Can be used independently or be wired into a central programming unit.</p>
	<p>Alura control unit (Z23180): (Class II IPX4 Zone 1 bath and Zone 2 shower) Electronic temperature control unit ensuring precise regulation of temperature. 6 temperature settings plus 5 mode settings. (No heat, frost protection, comfort, Eco, and auto for central programming).</p>
	<p>Premium (Class II IPX4 - Zone 1 bath and Zone 2 shower) Ergonomically positioned control unit. 5 heat settings plus option to reduce the set level by 3.5°C for night time use. Central and manual programming functions.</p>

Factory-fitted/self-fit options

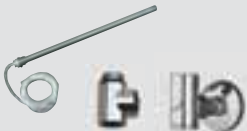
	<p>DBM (Class II IPX4 - Zone 1 bath and Zone 2 shower) Manual and programmable operations, 2 temperature settings, 2 hour programmable timer. Equipped with a thermal fuse. Chromium plated t-piece included with dual energy version.</p>
	<p>DE Pack (Class I IPX5 - Zone 1 bath and Zone 2 shower) Electric element without controls. Chromium plated t-piece included with dual energy version. Optional Zehnder simple immersion heater element and cable cover - Chrome Finish</p>

Technical specifications

Zehnder's aim is to provide reliability and precision at every stage of the design process and give specifiers and installers confidence in the sizing of radiators in order to avoid issues of under-performance in operation.

All Zehnder radiators have the CE mark, having been independently tested in accredited laboratories to EN442 in accordance with CE requirements, and our published heat output figures are fully in line with the testing criteria.

Consumers can be assured that the radiators will perform as stated.





Zehnder Quaro Spa

Stock Models														
Model code	Height mm	Width mm	Finish	Overall Projection mm	Pipe Centres mm		Outputs $\Delta T=50K$		Outputs $\Delta T=30K$		n Exponent	Weight kg	Water Content litres	Max. Immersion Rating
					radiator	from wall	Watts	Btu	Watts	Btu				
QS-075-045	803	450	white/colour	90-100	418	75-85	332	1133	177	605	1.23	7.5	3.7	200
QS-120-045	1251	450	white/colour	90-100	418	75-85	493	1682	262	894	1.24	10.3	5.4	300
QS-120-055	1251	550	white/colour	90-100	518	75-85	580	1979	308	1051	1.24	12	6.3	400
QS-150-045	1507	450	white/colour	90-100	418	75-85	588	2006	312	1063	1.24	11.9	6.5	400
QS-150-055	1507	550	white/colour	90-100	518	75-85	694	2368	368	1254	1.24	14	7.4	500
QS-180-055	1827	550	white/colour	90-100	518	75-85	851	2904	452	1544	1.24	16.9	9.2	600
QSC-075-045	803	450	chrome	90-100	418	75-85	206	703	108	368	1.27	7.1	3.7	150
QSC-120-045	1251	450	chrome	90-100	418	75-85	313	1068	163	557	1.28	9.8	5.4	200
QSC-120-055	1251	550	chrome	90-100	518	75-85	376	1283	197	671	1.27	11.6	6.3	300
QSC-150-045	1507	450	chrome	90-100	418	75-85	371	1266	192	656	1.29	11.3	6.5	300
QSC-150-055	1507	550	chrome	90-100	518	75-85	443	1512	230	783	1.29	13.4	7.4	300
QSC-180-055	1827	550	chrome	90-100	518	75-85	544	1856	283	965	1.28	16.1	9.2	400

Max. Working Pressure: 10 bar Test House: WSP-LAB
 Max. Working Temperature: xxx°C Test House No: 1428

Zehnder Vitalo Bar

Stock Models														
Model code	Height mm	Width mm	Finish	Overall Projection mm	Pipe Centres mm		Outputs $\Delta T=50K$		Outputs $\Delta T=30K$		n Exponent	Weight kg	Water Content litres	Max. Immersion Rating
					radiator	from wall	Watts	Btu	Watts	Btu				
VIP-125-040	1250	400	white	115	50	60	465	1587	249	850	1.22	7.0	0.7	
VIP-125-050	1250	500	white	115	50	60	555	1894	298	1017	1.22	8.7	0.8	
VIP-125-060	1250	600	white	115	50	60	641	2187	345	1177	1.21	10.5	0.9	
VIP-160-040	1600	400	white	115	50	60	546	1863	296	1010	1.20	9.3	0.7	
VIP-160-050	1600	500	white	115	50	60	676	2307	364	1242	1.21	11.4	0.9	
VIP-160-060	1600	600	white	115	50	60	806	2750	434	1481	1.21	13.6	1.0	
VIP-190-040	1900	400	white	115	50	60	673	2296	363	1239	1.21	10.9	0.9	
VIP-190-050	1900	500	white	115	50	60	834	2846	450	1535	1.21	12.7	1.1	
VIP-190-060	1900	600	white	115	50	60	994	3392	536	1829	1.21	14.6	1.3	

Max. Working Pressure: 10 bar Test House: WSP-LAB
 Max. Working Temperature: 80°C Test House No: 1428

Zehnder Klaro

Stock Models														
Model code	Height mm	Width mm	Finish	Overall Projection mm	Pipe Centres mm		Outputs $\Delta T=50K$		Outputs $\Delta T=30K$		n Exponent	Weight kg	Water Content litres	Max. Immersion Rating
					radiator	from wall	Watts	Btu	Watts	Btu				
ZSL-080-045	748	450	white/colour	87 to 102	412	68 to 83	354	1208	187	638	1.25	5.4	3.6	200
ZSL-080-050	748	500	white/colour	87 to 102	462	68 to 83	388	1324	205	699	1.25	5.8	3.8	200
ZSL-080-060	748	600	white/colour	87 to 102	562	68 to 83	455	1552	240	819	1.25	6.7	4.3	300
ZSL-120-045	1148	450	white/colour	87 to 102	412	68 to 83	521	1778	272	928	1.27	8.1	5.4	300
ZSL-120-050	1148	500	white/colour	87 to 102	462	68 to 83	571	1948	298	1017	1.27	8.7	5.8	400
ZSL-120-060	1148	600	white/colour	87 to 102	562	68 to 83	670	2286	352	1201	1.26	9.8	6.6	500
ZSL-150-050	1466	500	white/colour	87 to 102	462	68 to 83	716	2443	372	1269	1.28	10.9	7.4	500
ZSL-150-060	1466	600	white/colour	87 to 102	562	68 to 83	839	2863	436	1488	1.28	12.3	8.5	500
ZSL-170-045	1708	450	white/colour	87 to 102	412	68 to 83	751	2562	385	1314	1.31	11.2	7.9	500
ZSL-170-050	1708	500	white/colour	87 to 102	462	68 to 83	824	2811	424	1447	1.30	12.2	8.5	500
ZSL-170-060	1708	600	white/colour	87 to 102	562	68 to 83	966	3296	502	1713	1.28	14.2	9.6	600
ZSLC-080-050	748	500	chrome	87 to 102	462	68 to 83	283	966	146	498	1.30	5.8	3.8	200
ZSLC-080-060	748	600	chrome	87 to 102	562	68 to 83	332	1133	172	587	1.29	6.7	4.3	200
ZSLC-120-050	1148	500	chrome	87 to 102	462	68 to 83	417	1423	216	737	1.29	8.7	5.8	300
ZSLC-120-060	1148	600	chrome	87 to 102	562	68 to 83	489	1668	250	853	1.31	9.8	6.6	300
ZSLC-150-050	1466	500	chrome	87 to 102	462	68 to 83	475	1621	241	822	1.33	10.5	7.3	300
ZSLC-150-060	1466	600	chrome	87 to 102	562	68 to 83	560	1911	284	969	1.33	12.1	8.4	400
ZSLC-170-050	1708	600	chrome	87 to 102	562	68 to 83	601	2050	308	1051	1.31	12.2	8.5	400
ZSLC-170-060	1708	600	chrome	87 to 102	562	68 to 83	705	2405	361	1232	1.31	14.2	9.6	500

Max. Working Pressure: 4 bar Test House: HLK STUTTGART
 Max. Working Temperature: 110°C Test House No: 0626

Zehnder Subway

Stock Models														
Model code	Height mm	Width mm	Finish	Overall Projection mm	Pipe Centres mm		Outputs $\Delta T=50K$		Outputs $\Delta T=30K$		n Exponent	Weight kg	Water Content litres	Max. Immersion Rating
					radiator	from wall	Watts	Btu	Watts	Btu				
SUB-060-045	613	450	white/colour	70 to 80	50 or 418	55 to 65	310	1058	164	560	1.25	5.2	2.3	200
SUB-100-045	973	450	white/colour	70 to 80	50 or 418	55 to 65	401	1368	212	723	1.25	6.7	3.5	300
SUB-100-060	973	600	white/colour	70 to 80	50 or 568	55 to 65	499	1703	264	901	1.25	8.3	4.3	300
SUB-130-045	1261	450	white/colour	70 to 80	50 or 418	55 to 65	509	1737	269	918	1.25	8.6	4.5	300
SUB-130-060	1261	600	white/colour	70 to 80	50 or 568	55 to 65	639	2180	337	1150	1.25	10.5	5.4	400
SUB-150-045	1549	450	white/colour	70 to 80	50 or 418	55 to 65	615	2098	325	1109	1.25	10.6	5.4	400
SUB-150-060	1549	600	white/colour	70 to 80	50 or 568	55 to 65	772	2634	408	1392	1.25	12.5	7.2	500
SUB-180-045	1837	450	white/colour	70 to 80	50 or 418	55 to 65	715	2440	380	1297	1.24	12.2	6.3	500
SUB-180-060	1837	600	white/colour	70 to 80	50 or 568	55 to 65	898	3064	477	1628	1.24	14.7	7.7	600
SUBC-060-045	613	450	chrome	70 to 80	50 or 418	55 to 65	205	699	107	365	1.27	5.0	2.3	100
SUBC-100-045	973	450	chrome	70 to 80	50 or 418	55 to 65	265	904	139	474	1.27	6.5	3.5	200
SUBC-100-060	973	600	chrome	70 to 80	50 or 568	55 to 65	329	1123	173	590	1.26	8.1	4.3	200
SUBC-130-045	1261	450	chrome	70 to 80	50 or 418	55 to 65	335	1143	175	597	1.27	8.4	4.5	200
SUBC-130-060	1261	600	chrome	70 to 80	50 or 568	55 to 65	406	1385	213	727	1.26	10.2	5.4	300
SUBC-150-045	1549	450	chrome	70 to 80	50 or 418	55 to 65	420	1433	220	751	1.27	10.1	5.4	300
SUBC-150-060	1549	600	chrome	70 to 80	50 or 568	55 to 65	508	1733	267	911	1.26	12.3	7.2	300
SUBC-180-045	1837	450	chrome	70 to 80	50 or 418	55 to 65	485	1655	254	867	1.27	11.8	6.3	300
SUBC-180-060	1837	600	chrome	70 to 80	50 or 568	55 to 65	592	2020	311	1061	1.26	14.3	7.7	400

Max. Working Pressure: 20 bar
Max. Working Temperature: 120°C

Test House: HLK STUTTGART
Test House No: 0626

Zehnder Sfera Bow

Stock Models														
Model code	Height mm	Width mm	Finish	Overall Projection mm	Pipe Centres mm		Outputs $\Delta T=50K$		Outputs $\Delta T=30K$		n Exponent	Weight kg	Water Content litres	Max. Immersion Rating
					radiator	from wall	Watts	Btu	Watts	Btu				
SH-086-050	859	498	white/colour	138 to 153	446	70 to 85	460	1569	245	836	1.23	8.0	4.1	300
SH-086-060	859	593	white/colour	138 to 153	541	70 to 85	554	1890	296	1010	1.23	9.2	4.6	300
SH-126-050	1255	498	white/colour	138 to 153	446	70 to 85	710	2423	379	1293	1.23	12.5	6.3	500
SH-126-060	1255	593	white/colour	138 to 153	541	70 to 85	850	2900	453	1546	1.23	14.4	7.0	600
SH-175-050	1750	498	white/colour	138 to 153	446	70 to 85	946	3228	505	1723	1.23	17.3	8.7	600
SH-175-060	1750	593	white/colour	138 to 153	541	70 to 85	1126	3841	601	2051	1.23	19.8	9.7	750
SHC-086-050	859	498	chrome	138 to 153	446	70 to 85	316	1078	169	577	1.23	8.0	4.1	200
SHC-086-060	859	593	chrome	138 to 153	541	70 to 85	350	1194	187	638	1.23	9.2	4.6	200
SHC-126-050	1255	498	chrome	138 to 153	446	70 to 85	476	1624	254	867	1.23	12.5	6.3	300
SHC-126-060	1255	593	chrome	138 to 153	541	70 to 85	573	1955	306	1044	1.23	14.4	7.0	300
SHC-175-050	1750	498	chrome	138 to 153	446	70 to 85	650	2218	347	1184	1.23	17.3	8.7	500
SHC-175-060	1750	593	chrome	138 to 153	541	70 to 85	775	2644	413	1409	1.23	19.8	9.7	500

Max. Working Pressure: 4 bar
Max. Working Temperature: 110°C

Test House: WSP-LAB
Test House No: 1428

Zehnder Yucca Asym

Stock Models														
Model code	Height mm	Width mm	Finish	Overall Projection mm	Pipe Centres mm		Outputs $\Delta T=50K$		Outputs $\Delta T=30K$		n Exponent	Weight kg	Water Content litres	Max. Immersion Rating
					radiator	from wall	Watts	Btu	Watts	Btu				
Single tube														
YA-090-050	872	478	white/colour	82 to 97	50	48 to 63	353	1204	183	624	1.29	9.2	2.8	200
YA-130-040	1304	378	white/colour	82 to 97	50	48 to 63	439	1498	232	792	1.25	11.3	3.6	300
YA-130-050	1304	478	white/colour	82 to 97	50	48 to 63	525	1791	272	928	1.29	13.6	4.2	300
YA-130-060	1304	578	white/colour	82 to 97	50	48 to 63	607	2071	314	1071	1.29	15.9	4.7	400
YA-170-040	1736	378	white/colour	82 to 97	50	48 to 63	574	1958	298	1017	1.28	15.0	4.8	400
YA-170-050	1736	478	white/colour	82 to 97	50	48 to 63	696	2375	360	1228	1.29	18.1	5.6	500
YA-170-060	1736	578	white/colour	82 to 97	50	48 to 63	798	2723	411	1402	1.30	21.1	6.3	500
YAC-090-050	872	478	chrome	82 to 97	50	48 to 63	247	842	128	437	1.29	9.2	2.8	150
YAC-130-040	1304	378	chrome	82 to 97	50	48 to 63	307	1047	162	553	1.25	11.3	3.6	200
YAC-130-050	1304	478	chrome	82 to 97	50	48 to 63	367	1254	190	648	1.29	13.6	4.2	200
YAC-130-060	1304	578	chrome	82 to 97	50	48 to 63	424	1447	219	747	1.29	15.9	4.7	300
YAC-170-040	1736	378	chrome	82 to 97	50	48 to 63	402	1372	209	713	1.28	15.0	4.8	300
YAC-170-050	1736	478	chrome	82 to 97	50	48 to 63	487	1662	252	860	1.29	18.1	5.6	300
YAC-170-060	1736	578	chrome	82 to 97	50	48 to 63	559	1907	288	983	1.30	21.1	6.3	300
Double tube														
YAD-130-040	1304	378	white/colour	124 to 139	50	92 to 107	625	2133	322	1099	1.30	19.7	5.7	400
YAD-130-060	1304	578	white/colour	124 to 139	50	92 to 107	880	3003	442	1508	1.35	28.9	8.0	600
YAD-170-040	1736	378	white/colour	124 to 139	50	92 to 107	832	2838	430	1467	1.29	26.2	7.7	500
YAD-170-050	1736	478	white/colour	124 to 139	50	92 to 107	995	3395	510	1740	1.31	32.3	9.1	600
YAD-170-060	1736	578	white/colour	124 to 139	50	92 to 107	1151	3927	580	1979	1.34	38.4	10.6	750
Max. Working Pressure: 12 bar				Test House: WSP-LAB										
Max. Working Temperature: 120°C				Test House No: 1428										

Zehnder Yucca Sym

Stock Models														
Model code	Height mm	Width mm	Finish	Overall Projection mm	Pipe Centres mm		Outputs $\Delta T=50K$		Outputs $\Delta T=30K$		n Exponent	Weight kg	Water Content litres	Max. Immersion Rating
					radiator	from wall	Watts	Btu	Watts	Btu				
Single tube														
YS-090-050	908	500	white/colour	82 to 97	50	48 to 63	321	1129	170	580	1.24	8.4	2.6	200
YS-130-050	1340	500	white/colour	82 to 97	50	48 to 63	477	1628	251	856	1.26	12.6	4.0	300
YS-130-060	1340	600	white/colour	82 to 97	50	48 to 63	541	1846	284	969	1.26	14.2	4.3	300
YS-130-080	1340	800	white/colour	82 to 97	50	48 to 63	661	2255	346	1181	1.27	17.2	5.1	500
YS-180-050	1772	500	white/colour	82 to 97	50	48 to 63	621	2119	328	1119	1.25	16.8	5.2	400
YS-180-060	1772	600	white/colour	82 to 97	50	48 to 63	706	2409	371	1266	1.26	18.8	5.7	500
YS-180-080	1772	800	white/colour	82 to 97	50	48 to 63	863	2945	447	1525	1.29	22.9	6.7	600
YSC-090-050	908	500	chrome	82 to 97	50	48 to 63	224	764	119	406	1.24	8.4	2.6	150
YSC-130-050	1340	500	chrome	82 to 97	50	48 to 63	333	1136	175	597	1.26	12.6	4.0	200
YSC-130-060	1340	600	chrome	82 to 97	50	48 to 63	378	1290	199	679	1.26	14.2	4.3	300
YSC-130-080	1340	800	chrome	82 to 97	50	48 to 63	462	1576	241	822	1.27	17.2	5.1	300
YSC-180-050	1772	500	chrome	82 to 97	50	48 to 63	434	1481	229	781	1.25	16.8	5.2	300
YSC-180-060	1772	600	chrome	82 to 97	50	48 to 63	494	1686	260	887	1.26	18.8	5.7	300
YSC-180-080	1772	800	chrome	82 to 97	50	48 to 63	604	2061	313	1068	1.29	22.9	6.7	400
Double tube														
YSD-130-050	1340	500	white/colour	124 to 139	50	92 to 107	717	2446	375	1280	1.27	22.3	6.4	500
YSD-130-060	1340	600	white/colour	124 to 139	50	92 to 107	823	2808	428	1460	1.28	25.3	7.1	500
YSD-130-080	1340	800	white/colour	124 to 139	50	92 to 107	1024	3494	527	1798	1.30	31.4	8.5	600
YSD-180-050	1772	500	white/colour	124 to 139	50	92 to 107	926	3159	479	1634	1.29	29.6	8.4	600
YSD-180-060	1772	600	white/colour	124 to 139	50	92 to 107	1063	3627	547	1866	1.30	33.7	9.4	600
YSD-180-080	1772	800	white/colour	124 to 139	50	92 to 107	1322	4511	674	2300	1.32	41.8	11.4	900
Max. Working Pressure: 12 bar				Test House: WSP-LAB										
Max. Working Temperature: 120°C				Test House No: 1428										

Zehnder Metropolitan Spa

Stock Models														
Model code	Height mm	Width mm	Finish	Overall Projection mm	Pipe Centres mm		Outputs $\Delta T=50K$		Outputs $\Delta T=30K$		n Exponent	Weight kg	Water Content litres	Max. Immersion Rating
					radiator	from wall	Watts	Btu	Watts	Btu				
MET-080-040	805	400	white/colour	79 to 89	50 or 320	60 to 70	327	1116	173	590	1.25	6.5	3.5	250
MET-080-050	805	500	white/colour	79 to 89	50 or 420	60 to 70	388	1324	204	696	1.26	7.8	3.8	300
MET-080-060	805	600	white/colour	79 to 89	50 or 520	60 to 70	445	1518	233	795	1.27	9.1	4.2	300
MET-120-040	1225	400	white/colour	79 to 89	50 or 320	60 to 70	474	1617	249	850	1.26	9.8	4.8	300
MET-120-050	1225	500	white/colour	79 to 89	50 or 420	60 to 70	561	1914	295	1007	1.26	11.7	5.2	400
MET-120-060	1225	600	white/colour	79 to 89	50 or 520	60 to 70	645	2201	337	1150	1.27	13.5	5.7	400
MET-150-040	1540	400	white/colour	79 to 89	50 or 320	60 to 70	582	1986	306	1044	1.26	11.5	5.4	400
MET-150-050	1540	500	white/colour	79 to 89	50 or 420	60 to 70	690	2354	361	1232	1.27	13.5	5.9	500
MET-180-050	1750	500	white/colour	79 to 89	50 or 420	60 to 70	775	2644	407	1389	1.26	16.3	7.3	500
MET-180-060	1750	600	white/colour	79 to 89	50 or 520	60 to 70	889	3033	465	1587	1.27	19.0	8.0	600

Max. Working Pressure: 4 bar
Max. Working Temperature: 120°C

Test House: HLK STUTTGART
Test House No: 0626

Zehnder Ax Spa

Stock Models														
Model code	Height mm	Width mm	Finish	Overall Projection mm	Pipe Centres mm		Outputs $\Delta T=50K$		Outputs $\Delta T=30K$		n Exponent	Weight kg	Water Content litres	Max. Immersion Rating
					radiator	from wall	Watts	Btu	Watts	Btu				
Single tube														
ZA-048-040	484	400	white/colour	97 to 112	350	70 to 85	230	785	118	403	1.31	4.5	2.2	n/a
ZA-060-080	575	800	white/colour	97 to 112	750	70 to 85	458	1563	235	802	1.31	10.2	2.1	300
ZA-060-090	575	900	white/colour	97 to 112	850	70 to 85	515	1757	264	901	1.31	11.3	2.2	300
ZA-060-100	575	1000	white/colour	97 to 112	950	70 to 85	573	1955	293	1000	1.31	12.4	2.4	300
ZA-060-120	575	1200	white/colour	97 to 112	1150	70 to 85	687	2344	352	1202	1.31	14.5	2.6	300
ZA-080-050	836	500	white/colour	97 to 112	450	70 to 85	427	1457	225	768	1.25	8.6	2.4	300
ZA-120-050	1188	500	white/colour	97 to 112	450	70 to 85	586	1999	311	1061	1.24	12.0	3.3	300
ZA-120-060	1188	600	white/colour	97 to 112	550	70 to 85	685	2337	364	1242	1.24	13.7	3.5	500
ZA-150-040	1540	400	white/colour	97 to 112	350	70 to 85	614	2095	326	1112	1.24	12.3	4.0	400
ZA-150-050	1540	500	white/colour	97 to 112	450	70 to 85	738	2518	392	1338	1.23	14.4	4.3	500
ZA-180-050	1804	500	white/colour	97 to 112	450	70 to 85	884	3016	472	1610	1.25	18.6	5.1	600
ZAC-080-050	836	500	chrome	97 to 112	450	70 to 85	300	1024	158	539	1.24	8.6	2.4	300
ZAC-120-050	1188	500	chrome	97 to 112	450	70 to 85	410	1399	218	744	1.24	12.0	3.3	300
ZAC-120-060	1188	600	chrome	97 to 112	550	70 to 85	480	1638	255	870	1.24	13.7	3.5	500
ZAC-150-040	1540	400	chrome	97 to 112	350	70 to 85	430	1467	228	778	1.24	12.3	4.0	400
ZAC-150-050	1540	500	chrome	97 to 112	450	70 to 85	520	1774	276	942	1.23	14.4	4.3	500
ZAC-180-050	1804	500	chrome	97 to 112	450	70 to 85	620	2115	331	1129	1.23	18.6	5.1	600
Double tube														
ZAD-150-050	1540	500	white/colour	97 to 112	450	70 to 85	1049	3579	548	1870	1.27	25.3	5.4	n/a
ZAD-180-050	1804	500	white/colour	97 to 112	450	70 to 85	1262	4306	653	2228	1.29	30.5	6.5	n/a
ZAD-180-060	1804	600	white/colour	97 to 112	550	70 to 85	1485	5067	772	2634	1.28	35.6	7.1	n/a

Max. Working Pressure: 4 bar
Max. Working Temperature: 110°C

Test House: CETIAT
Test House No: 1623

Zehnder Roda Spa

Stock Models														
Model code	Height mm	Width mm	Finish	Overall Projection mm	Pipe Centres mm		Outputs $\Delta T=50K$		Outputs $\Delta T=30K$		n Exponent	Weight kg	Water Content litres	Max. Immersion Rating
					radiator	from wall	Watts	Btu	Watts	Btu				
RO-060-100	667	1000	white/colour	98 to 113	932	70 to 85	656	2238	343	1170	1.27	14.6	5.5	400
RO-070-050	741	500	white/colour	98 to 113	432	70 to 85	377	1286	197	672	1.27	8.2	3.7	400
RO-100-050	1037	500	white/colour	98 to 113	432	70 to 85	504	1720	265	904	1.26	12.2	5.1	400
RO-120-050	1259	500	white/colour	98 to 113	432	70 to 85	583	1989	308	1051	1.25	14.0	6.1	400
RO-150-050	1481	500	white/colour	98 to 113	432	70 to 85	691	2358	367	1252	1.24	16.5	7.3	400
RO-180-050	1851	500	white/colour	98 to 113	432	70 to 85	817	2788	438	1494	1.22	21.5	9.2	400
RO-180-060	1851	600	white/colour	98 to 113	532	70 to 85	980	3344	525	1791	1.22	23.5	10.3	400
RO-180-080	1851	800	white/colour	98 to 113	732	70 to 85	1307	4460	701	2392	1.22	31.5	12.5	400

Max. Working Pressure: 4 bar
Max. Working Temperature: 110°C

Test House: CETIAT
Test House No: 1623

Zehnder Roda Spa Asym

Stock Models														
Model code	Height mm	Width mm	Finish	Overall Projection mm	Pipe Centres mm		Outputs $\Delta T=50K$		Outputs $\Delta T=30K$		n Exponent	Weight kg	Water Content litres	Immersion Rating
					radiator	from wall	Watts	Btu	Watts	Btu				
ROFL-080-055	805	550	white/colour	98 to 113	50	75 to 85	429	1464	228	778	1.23	10	4.3	300
ROFL-120-055	1183	550	white/colour	98 to 113	50	75 to 85	594	2027	314	1071	1.25	14	6.3	400
ROFL-170-055	1676	550	white/colour	98 to 113	50	75 to 85	809	2760	424	1447	1.27	20	8.8	500
ROFR-080-055	805	550	white/colour	98 to 113	50	75 to 85	429	1464	228	778	1.23	10	4.3	300
ROFR-120-055	1183	550	white/colour	98 to 113	50	75 to 85	594	2027	314	1071	1.25	14	6.3	400
ROFR-170-055	1676	550	white/colour	98 to 113	50	75 to 85	809	2760	424	1447	1.27	20	8.8	500

Zehnder Charleston Bar

Stock Models														
Model code	Height mm	Width mm	Finish	Overall Projection mm	Pipe Centres mm		Outputs $\Delta T=50K$		Outputs $\Delta T=30K$		n Exponent	Weight kg	Water Content litres	Immersion Rating
					radiator	from wall	Watts	Btu	Watts	Btu				
2075-06	742	306	white/colour	90	306 plus valves*		59	330	1128	174	594	1.25	7.2	4.2
2090-09	900	444	white/colour	90	444 plus valves*		59	575	1961	304	1037	1.25	12.6	7.2
2120-09	1200	444	white/colour	90	444 plus valves*		59	744	2358	391	1334	1.26	17.1	9.9
2150-09	1500	444	white/colour	90	444 plus valves*		59	936	3198	487	1662	1.28	20.7	11.7
2180-09	1800	444	white/colour	90	444 plus valves*		59	1116	3807	572	1952	1.31	24.3	13.5

*Nominal overall radiator Width = (Number of sections x 46mm) + 30mm. Manufacturing tolerance of +/- 0.6mm per section

Max. Working Pressure: 10 bar Test House: WSP-LAB
 Max. Working Temperature: 110°C Test House No: 1428

Zehnder Nobis

Stock Models														
Model code	Height mm	Width mm	Finish	Overall Projection mm	Pipe Centres mm		Outputs $\Delta T=50K$		Outputs $\Delta T=30K$		n Exponent	Weight kg	Water Content litres	Immersion Rating
					radiator	from wall	Watts	Btu	Watts	Btu				
NOB-100-050	965	500	chrome	97 to 109	50	76 to 88	210	717	109	372	1.28	9.0	2.0	
NOB-150-050	1520	500	chrome	97 to 109	50	76 to 88	325	1109	167	570	1.30	14.0	3.2	

Max. Working Pressure: 12 bar Test House: HLK STUTTGART
 Max. Working Temperature: 120°C Test House No: 0626

Zehnder Balmoral

Stock Models														
Model code	Height mm	Width mm	Finish	Overall Projection mm	Pipe Centres mm		Outputs $\Delta T=50K$		Outputs $\Delta T=30K$		n Exponent	Weight kg	Water Content litres	Immersion Rating
					radiator	from wall	Watts	Btu	Watts	Btu				

Zehnder Balmoral central heating

BALM CPHO	850	735	white/colour	250	488	100	683	2330	355	1211	1.3146	24	10	n/a
-----------	-----	-----	--------------	-----	-----	-----	-----	------	-----	------	--------	----	----	-----

Max. Working Pressure: 5 bar Test House: BSRIA
 Max. Working Temperature: 120°C Test House No: 0480

Zehnder Osbourne

Stock Models														
Model code	Height mm	Width mm	Finish	Overall Projection mm	Pipe Centres mm		Outputs $\Delta T=50K$		Outputs $\Delta T=30K$		n Exponent	Weight kg	Water Content litres	Immersion Rating
					radiator	from wall	Watts	Btu	Watts	Btu				

Zehnder Osbourne hot water

OSBO CPHO	850	600	chrome	140	355	100	246	839	128	437	1.2318	10.0	3.0	n/a
-----------	-----	-----	--------	-----	-----	-----	-----	-----	-----	-----	--------	------	-----	-----

Max. Working Pressure: 5 bar Test House: BSRIA
 Max. Working Temperature: 120°C Test House No: 0480

Zehnder Buckingham

Stock Models														
Model code	Height mm	Width mm	Finish	Overall Projection mm	Pipe Centres mm		Outputs $\Delta T=50K$		Outputs $\Delta T=30K$		n Exponent	Weight kg	Water Content litres	Immersion Rating
					radiator	from wall	Watts	Btu	Watts	Btu				
Zehnder Buckingham hot water														
BUCK CPHO	750	500	chrome	120	425	50	175	597	91	310	1.2303	8.0	1.9	150
Max. Working Pressure: 5 bar				Test House: BSRIA										
Max. Working Temperature: 120°C				Test House No: 0480										

Zehnder Stellar

Stock Models														
Model code	Height mm	Width mm	Finish	Overall Projection mm	Pipe Centres mm		Outputs $\Delta T=50K$		Outputs $\Delta T=30K$		n Exponent	Weight kg	Water Content litres	Max. Immersion Rating
					radiator	from wall	Watts	Btu	Watts	Btu				
STNI-060-045	572	450	polished	90 to 100	420	75 to 85	159	541	84	287	1.24	3.3	2.0	100
STNI-060-100	572	1000	polished	90 to 100	970	75 to 85	284	970	152	519	1.22	5.8	3.6	200
STNI-080-030	788	300	polished	90 to 100	270	75 to 85	159	541	85	290	1.23	3.6	2.2	100
STNI-080-045	788	450	polished	90 to 100	420	75 to 85	206	702	109	372	1.24	4.5	2.8	150
STNI-080-060	788	600	polished	90 to 100	570	75 to 85	253	863	135	459	1.23	5.4	3.4	150
STNI-120-030	1220	300	polished	90 to 100	270	75 to 85	242	826	129	440	1.23	5.5	3.5	150
STNI-120-045	1220	450	polished	90 to 100	420	75 to 85	316	1078	166	567	1.26	6.9	4.3	150
STNI-120-060	1220	600	polished	90 to 100	570	75 to 85	391	1334	208	710	1.24	8.4	5.2	200
STNI-150-045	1508	450	polished	90 to 100	420	75 to 85	389	1327	206	703	1.24	8.5	5.1	300
STNI-150-060	1508	600	polished	90 to 100	570	75 to 85	491	1675	258	882	1.26	10.2	6.2	300
STNI-170-045	1724	450	polished	90 to 100	420	75 to 85	452	1542	241	822	1.23	10.0	6.1	300
STNI-170-060	1724	600	polished	90 to 100	570	75 to 85	545	1860	288	983	1.25	12.0	7.2	400
STNI-060-045-CF	572	450	painted	90 to 100	420	75 to 85	233	795	125	426	1.22	3.3	2.0	100
STNI-060-100-CF	572	1000	painted	90 to 100	970	75 to 85	430	1467	231	787	1.23	5.8	3.6	200
STNI-080-030-CF	788	300	painted	90 to 100	270	75 to 85	232	792	124	424	1.23	3.6	2.2	100
STNI-080-045-CF	788	450	painted	90 to 100	420	75 to 85	317	1082	170	580	1.22	4.5	2.8	150
STNI-080-060-CF	788	600	painted	90 to 100	570	75 to 85	395	1348	212	723	1.22	5.4	3.4	150
STNI-120-030-CF	1220	300	painted	90 to 100	270	75 to 85	353	1204	188	643	1.23	5.5	3.5	150
STNI-120-045-CF	1220	450	painted	90 to 100	420	75 to 85	482	1645	258	882	1.23	6.9	4.3	150
STNI-120-060-CF	1220	600	painted	90 to 100	570	75 to 85	600	2047	322	1098	1.22	8.4	5.2	200
STNI-150-045-CF	1508	450	painted	90 to 100	420	75 to 85	591	2016	315	1076	1.23	8.5	5.1	300
STNI-150-060-CF	1508	600	painted	90 to 100	570	75 to 85	736	2511	393	1340	1.23	10.2	6.2	300
STNI-170-045-CF	1724	450	painted	90 to 100	420	75 to 85	672	2293	359	1223	1.23	10.0	6.1	300
STNI-170-060-CF	1724	600	painted	90 to 100	570	75 to 85	838	2859	449	1533	1.23	12.0	7.2	400
Max. Working Pressure: 10 bar				Test House: HLK STUTTGART										
Max. Working Temperature: 120°C				Test House No: 0626										

Zehnder Quaro Spa

Stock Models														
Model code	Height mm	Width mm	Finish	Overall Projection mm	Pipe Centres mm		Outputs $\Delta T=50K$		Outputs $\Delta T=30K$		n Exponent	Weight kg	Water Content litres	Max. Immersion Rating
					radiator	from wall	Watts	Btu	Watts	Btu				
QSI-075-045	803	450	Stainless steel	90-100	418	75-85	222	757	116	396	1.27	7.1	3.7	150
QSI-120-045	1251	450	Stainless steel	90-100	418	75-85	330	1126	173	589	1.27	9.8	5.4	200
QSI-120-055	1251	550	Stainless steel	90-100	518	75-85	388	1324	204	694	1.26	11.6	6.2	300
QSI-150-045	1507	450	Stainless steel	90-100	418	75-85	393	1341	204	697	1.28	11.3	6.4	300
QSI-150-055	1507	550	Stainless steel	90-100	518	75-85	464	1583	241	823	1.28	13.4	7.3	300
QSI-180-055	1827	550	Stainless steel	90-100	518	75-85	569	1941	297	1013	1.27	16.1	8.9	400
Max. Working Pressure: 10 bar				Test House: WSP-LAB										
Max. Working Temperature: xxx°C				Test House No: 1428										

Zehnder Stellar Spa

Stock Models														
Model code	Height mm	Width mm	Finish	Overall Projection mm	Pipe Centres mm		Outputs $\Delta T=50K$		Outputs $\Delta T=30K$		n Exponent	Weight kg	Water Content litres	Max. Immersion Rating
					radiator	from wall	Watts	Btu	Watts	Btu				
STGI-060-045	572	450	polished	90 to 100	420	75 to 85	161	549	84	287	1.27	3.1	1.8	100
STGI-060-100	572	1000	polished	90 to 100	970	75 to 85	272	928	144	491	1.24	5.3	3.0	150
STGI-080-030	788	300	polished	90 to 100	270	75 to 85	171	583	89	304	1.28	3.4	2.0	100
STGI-080-045	788	450	polished	90 to 100	420	75 to 85	220	751	115	392	1.27	4.2	3.0	100
STGI-080-060	788	600	polished	90 to 100	570	75 to 85	243	829	128	435	1.26	5.0	3.2	150
STGI-120-030	1220	300	polished	90 to 100	270	75 to 85	240	819	125	427	1.28	5.2	3.1	150
STGI-120-045	1220	450	polished	90 to 100	420	75 to 85	309	1054	161	549	1.28	6.5	3.9	150
STGI-120-060	1220	600	polished	90 to 100	570	75 to 85	379	1293	197	672	1.28	7.7	4.6	200
STGI-150-045	1508	450	polished	90 to 100	420	75 to 85	361	1232	187	639	1.28	7.8	4.7	300
STGI-150-060	1508	600	polished	90 to 100	570	75 to 85	448	1529	233	795	1.28	9.3	5.6	300
STGI-170-045	1724	450	polished	90 to 100	420	75 to 85	434	1481	226	771	1.28	9.4	5.3	200
STGI-170-060	1724	600	polished	90 to 100	570	75 to 85	517	1764	270	921	1.27	11.2	6.5	300
STGI-060-045-CF	572	450	painted	90 to 100	420	75 to 85	219	747	117	401	1.23	3.1	1.8	100
STGI-060-100-CF	572	1000	painted	90 to 100	970	75 to 85	394	1344	211	721	1.23	5.3	3.0	150
STGI-080-030-CF	788	300	painted	90 to 100	270	75 to 85	218	744	117	399	1.23	3.4	2.0	100
STGI-080-045-CF	788	450	painted	90 to 100	420	75 to 85	294	1003	158	538	1.23	4.2	3.0	100
STGI-080-060-CF	788	600	painted	90 to 100	570	75 to 85	363	1239	194	661	1.23	5.0	3.2	150
STGI-120-030-CF	1220	300	painted	90 to 100	270	75 to 85	332	1133	177	604	1.23	5.2	3.1	150
STGI-120-045-CF	1220	450	painted	90 to 100	420	75 to 85	448	1529	239	815	1.24	6.5	3.9	150
STGI-120-060-CF	1220	600	painted	90 to 100	570	75 to 85	554	1890	294	1003	1.24	7.7	4.6	200
STGI-150-045-CF	1508	450	painted	90 to 100	420	75 to 85	556	1897	297	1012	1.24	7.8	4.7	300
STGI-150-060-CF	1508	600	painted	90 to 100	570	75 to 85	687	2344	367	1251	1.24	9.3	5.6	300
STGI-170-045-CF	1724	450	painted	90 to 100	420	75 to 85	640	2184	343	1171	1.23	9.4	5.3	200
STGI-170-060-CF	1724	600	painted	90 to 100	570	75 to 85	791	2699	422	1440	1.23	11.2	6.5	300

Max. Working Pressure: 10 bar Test House: HLK STUTTGART
 Max. Working Temperature: 120°C Test House No: 0626

Zehnder Subway Stainless Steel

Stock Models														
Model code	Height mm	Width mm	Finish	Overall Projection mm	Pipe Centres mm		Outputs $\Delta T=50K$		Outputs $\Delta T=30K$		n Exponent	Weight kg	Water Content litres	Max. Immersion Rating
					radiator	from wall	Watts	Btu	Watts	Btu				
SUBI-060-045	613	450	polished	70 to 80	50 or 418	55 to 65	221	754	116	396	1.27	5.1	2.3	150
SUBI-130-045	1261	450	polished	70 to 80	50 or 418	55 to 65	370	1262	193	659	1.27	8.7	4.5	200
SUBI-130-060	1261	600	polished	70 to 80	50 or 568	55 to 65	447	1525	235	802	1.26	10.4	5.4	300
SUBI-150-045	1549	450	polished	70 to 80	50 or 418	55 to 65	445	1518	233	795	1.27	10.4	5.4	300
SUBI-150-060	1549	600	polished	70 to 80	50 or 568	55 to 65	538	1836	283	966	1.26	12.4	7.2	300
SUBI-180-060	1837	600	polished	70 to 80	50 or 568	55 to 65	633	2160	334	1140	1.25	14.4	7.7	400

Max. Working Pressure: 10 bar Test House: HLK STUTTGART
 Max. Working Temperature: 120°C Test House No: 0626

Zehnder Cove

Stock Models														
Model code	Height mm	Width mm	Finish	Overall Projection mm	Pipe Centres mm		Outputs $\Delta T=50K$		Outputs $\Delta T=30K$		n Exponent	Weight kg	Water Content litres	Max. Immersion Rating
					radiator	from wall	Watts	Btu	Watts	Btu				
COVE-120-50	1180	500	brushed*	70 to 95	470	55 to 80	304	1037	158	539	1.28	10.3	3.6	200
COVE-120-60	1180	600	brushed*	70 to 95	570	55 to 80	351	1198	183	624	1.28	12.0	4.0	200
COVE-140-50	1360	500	brushed*	70 to 95	470	55 to 80	345	1177	178	607	1.3	11.6	4.1	200
COVE-140-60	1360	600	brushed*	70 to 95	570	55 to 80	402	1372	207	706	1.3	13.6	4.5	200

*brushed with polished trim
 Max. Working Pressure: 4 bar Test House: WSP-LAB
 Max. Working Temperature: 90°C Test House No: 1428

Zehnder Keel Asym

Stock Models														
Model code	Height mm	Width mm	Finish	Overall Projection mm	Pipe Centres mm		Outputs $\Delta T=50K$		Outputs $\Delta T=30K$		n Exponent	Weight kg	Water Content litres	Max. Immersion Rating
					radiator	from wall	Watts	Btu	Watts	Btu				
KEEL-A-120-50	1190	500	brushed*	65 to 100	50	35 to 70	307	1047	158	539	1.30	12.4	4.6	200
KEEL-A-140-50	1400	500	brushed*	65 to 100	50	35 to 70	357	1218	180	614	1.34	14.5	5.1	200
KEEL-AP-120-50	1190	500	polished	65 to 100	50	35 to 70	276	942	142	485	1.30	12.4	4.6	200
KEEL-AP-140-50	1400	500	polished	65 to 100	50	35 to 70	321	1096	162	553	1.34	14.5	5.1	200

*Brushed with polished trim

Max. Working Pressure: 4 bar

Test House: WSP-LAB

Max. Working Temperature: 90°C

Test House No: 1428

Zehnder Keel Sym

Stock Models														
Model code	Height mm	Width mm	Finish	Overall Projection mm	Pipe Centres mm		Outputs $\Delta T=50K$		Outputs $\Delta T=30K$		n Exponent	Weight kg	Water Content litres	Max. Immersion Rating
					radiator	from wall	Watts	Btu	Watts	Btu				
KEEL-SP-120-60	1190	600	polished	65 to 100	50	35 to 70	229	780	118	403	1.29	10.3	3.9	150
KEEL-SP-140-60	1400	600	polished	65 to 100	50	35 to 70	269	918	139	474	1.29	12.0	4.5	200

Max. Working Pressure: 4 bar

Test House: WSP-LAB

Max. Working Temperature: 90°C

Test House No: 1428

Zehnder Bay

Stock Models														
Model code	Height mm	Width mm	Finish	Overall Projection mm	Pipe Centres mm	Pipe Centres mm		Outputs $\Delta T=50K$		Outputs $\Delta T=30K$		n Exponent	Weight kg	Water Content litres
					vertical entry	radiator	from wall	Watts	Btu	Watts	Btu			
Zehnder Bay vertical (brushed steel finish)														
BAY-100-053	1000	530	brushed steel	70 to 95	480	530*	55-80	421	1436	209	713	1.37	15.3	13.50
BAY-120-047	1200	470	brushed steel	70 to 95	420	470*	55-80	458	1563	227	775	1.37	16	13.60
BAY-120-053	1200	530	brushed steel	70 to 95	480	530*	55-80	516	1761	256	873	1.37	18	15.3
BAY-150-029	1500	290	brushed steel	70 to 95	240	290*	55-80	365	1245	180	614	1.38	12.5	10.5
BAY-170-029	1700	290	brushed steel	70 to 95	240	290*	55-80	412	1406	203	693	1.39	14	12
BAY-170-047	1700	470	brushed steel	70 to 95	420	470*	55-80	659	2249	324	1105	1.39	22.4	19.2
BAY-170-053	1700	530	brushed steel	70 to 95	480	530*	55-80	742	2532	365	1245	1.39	25.2	21.6
BAYF-170-029	1700	290	brushed steel	70 to 95	240	290*	55-80	520	1774	256	873	1.39	17.2	12
BAYF-170-047	1700	470	brushed steel	70 to 95	420	470*	55-80	832	2839	409	1396	1.39	30.4	19.2
BAYF-170-053	1700	530	brushed steel	70 to 95	480	530*	55-80	936	3194	460	1570	1.39	34.2	21.6
Zehnder Bay horizontal (brushed steel finish)														
BAY-100-053	530	1000	brushed steel	70 to 95	930	1000*	55-80	421	1436	209	713	1.37	15.3	13.50
BAY-120-047	470	1200	brushed steel	70 to 95	420	470*	55-80	458	1563	227	775	1.37	16	13.60
BAY-120-053	530	1200	brushed steel	70 to 95	1130	1200*	55-80	516	1761	256	873	1.37	18	15.3
BAY-150-029	290	1500	brushed steel	70 to 95	1430	1500*	55-80	365	1245	180	614	1.38	12.5	10.5
BAY-170-029	290	1700	brushed steel	70 to 95	1630	1700*	55-80	412	1406	203	693	1.39	14	12
BAY-170-047	470	1700	brushed steel	70 to 95	1630	1700*	55-80	659	2249	324	1105	1.39	22.4	19.2
BAY-170-053	530	1700	brushed steel	70 to 95	1630	1700*	55-80	742	2532	365	1245	1.39	25.2	21.6

*plus valves

Max. Working Pressure: 4 bar

Test House: WSP-LAB

Max. Working Temperature: 90°C

Test House No: 1428

Zehnder Charleston

Stock Models													
Model code	Height mm	Width mm	Finish	Overall Projection mm	Pipe Centres mm		Outputs $\Delta T=50K$		Outputs $\Delta T=30K$		n Exponent	Weight kg	Water Content litres
					radiator	from wall	Watts	Btu	Watts	Btu			
Vertical													
2180-6	1800	306	white/colour	90	length plus valves*	59	744	2539	381	1300	1.31	16.4	9.0
2180-8	1800	398	white/colour	90	length plus valves*	59	992	3385	508	1733	1.31	21.9	12.0
2180-10	1800	490	white/colour	90	length plus valves*	59	1240	4231	635	2167	1.31	27.3	15.0
2180-12	1800	582	white/colour	90	length plus valves*	59	1488	5077	762	2600	1.31	32.8	18.0
3180-6	1800	306	white/colour	78	length plus valves*	59	996	3398	510	1740	1.31	24.6	14.0
3180-8	1800	398	white/colour	78	length plus valves*	59	1328	4531	680	2320	1.31	32.8	19.0
3180-10	1800	490	white/colour	78	length plus valves*	59	1660	5664	850	2900	1.31	41.0	24.0
Horizontal													
2050-10	500	490	white/colour	90	length plus valves*	59	384	1310	203	693	1.25	7.9	5.0
2050-14	500	674	white/colour	90	length plus valves*	59	538	1836	284	969	1.25	11.0	7.0
2050-18	500	858	white/colour	90	length plus valves*	59	691	2358	365	1245	1.25	14.2	9.0
2050-22	500	1042	white/colour	90	length plus valves*	59	845	2883	446	1522	1.25	17.4	11.0
2050-26	500	1226	white/colour	90	length plus valves*	59	998	3405	527	1798	1.25	20.5	13.0
2060-10	600	490	white/colour	90	length plus valves*	59	453	1546	239	815	1.25	9.5	6.0
2060-14	600	674	white/colour	90	length plus valves*	59	634	2163	335	1143	1.25	13.3	8.4
2060-18	600	858	white/colour	90	length plus valves*	59	815	2781	430	1467	1.25	17.1	10.8
2060-22	600	1042	white/colour	90	length plus valves*	59	997	3402	527	1798	1.25	20.9	13.2
2060-24	600	1134	white/colour	90	length plus valves*	59	1080	3685	570	1945	1.25	22.8	14.4
2060-28	600	1318	white/colour	90	length plus valves*	59	1260	4299	665	2269	1.25	26.6	16.8
3050-14	500	674	white/colour	128	length plus valves*	78	722	2463	381	1300	1.25	16.6	11.2
3050-18	500	858	white/colour	128	length plus valves*	78	929	3170	491	1675	1.25	21.4	14.4
3050-22	500	1042	white/colour	128	length plus valves*	78	1135	3873	599	2044	1.25	26.2	17.6
3050-26	500	1226	white/colour	128	length plus valves*	78	1342	4579	709	2419	1.25	30.9	20.8
3050-30	500	1410	white/colour	128	length plus valves*	78	1548	5282	817	2788	1.25	35.7	24.0
3060-10	600	490	white/colour	128	length plus valves*	78	609	2078	320	1092	1.26	13.9	9.0
3060-14	600	674	white/colour	128	length plus valves*	78	853	2910	448	1529	1.26	19.4	12.6
3060-18	600	858	white/colour	128	length plus valves*	78	1096	3740	576	1965	1.26	24.9	16.2
3060-20	600	950	white/colour	128	length plus valves*	78	1220	4163	641	2187	1.26	27.7	18.0
3060-24	600	1134	white/colour	128	length plus valves*	78	1464	4995	769	2624	1.26	33.2	21.6
3060-27	600	1272	white/colour	128	length plus valves*	78	1645	5613	864	2948	1.26	37.3	24.3
3060-30	600	1410	white/colour	128	length plus valves*	78	1827	6234	960	3276	1.26	41.6	27.0
3060-34	600	1594	white/colour	128	length plus valves*	78	2071	7066	1088	3712	1.26	47.0	30.6
3075-14	750	674	white/colour	128	length plus valves*	78	1040	3548	546	1863	1.26	24.3	15.4
3075-22	750	1042	white/colour	128	length plus valves*	78	1635	5579	859	2931	1.26	38.2	24.2
3075-26	750	1226	white/colour	128	length plus valves*	78	1932	6592	1015	3463	1.26	45.1	28.6
4030-20	300	950	white/colour	164	length plus valves*	96	840	2866	444	1515	1.25	21.3	14.0
4030-30	300	1410	white/colour	164	length plus valves*	96	1260	4299	665	2269	1.25	32.0	21.0
4060-14	600	674	white/colour	164	length plus valves*	96	1117	3811	584	1993	1.27	27.3	16.8
4060-18	600	858	white/colour	164	length plus valves*	96	1436	4900	751	2562	1.27	35.1	21.6
4060-20	600	950	white/colour	164	length plus valves*	96	1600	5459	836	2852	1.27	39.0	24.0
4060-24	600	1134	white/colour	164	length plus valves*	96	1920	6551	1004	3426	1.27	46.8	28.8
4075-14	750	674	white/colour	164	length plus valves*	96	1364	4654	713	2433	1.27	33.6	19.6
4075-18	750	858	white/colour	164	length plus valves*	96	1753	5981	916	3125	1.27	43.2	25.2
4075-22	750	1042	white/colour	164	length plus valves*	96	2143	7312	1120	3821	1.27	52.8	30.8
4075-26	750	1226	white/colour	164	length plus valves*	96	2532	8639	1323	4514	1.27	62.5	36.4

*Nominal overall radiator length = (Number of sections x 46mm) + 30mm. Manufacturing tolerance of +/- 0.6mm per section

Max. Working Pressure: 10 bar Test House: WSP-LAB
 Max. Working Temperature: 110°C Test House No: 2005

Zehnder Charleston

Made to Measure Options												
Model code	Height mm	Finish	Overall Projection mm	Pipe Centres mm		Outputs $\Delta T=50K$		Outputs $\Delta T=30K$		n Exponent	Weight kg	Water Content litres
				radiator	from wall	Watts	Btu	Watts	Btu			
2 column												
2019	177	white/colour	90	length + valves*	59	14.5	49.47	7.6	25.93	1.26	0.3	0.3
2030	292	white/colour	90	length + valves*	59	23.6	80.52	12.5	42.65	1.24	0.5	0.4
2040	392	white/colour	90	length + valves*	59	31.2	106.45	16.6	56.64	1.24	0.6	0.4
2045	442	white/colour	90	length + valves*	59	34.9	119.08	18.5	63.12	1.24	0.7	0.5
2050	492	white/colour	90	length + valves*	59	38.4	131.02	20.3	69.26	1.25	0.8	0.5
2055	542	white/colour	90	length + valves*	59	41.9	142.96	22.1	75.41	1.25	0.9	0.6
2060	592	white/colour	90	length + valves*	59	45.3	154.56	23.9	81.55	1.25	1.0	0.6
2075	742	white/colour	90	length + valves*	59	55	187.66	29	98.95	1.25	1.2	0.7
2090	892	white/colour	90	length + valves*	59	63.9	218.03	33.7	114.98	1.25	1.4	0.8
2100	992	white/colour	90	length + valves*	59	69.5	237.13	36.7	125.22	1.25	1.6	0.9
2120	1192	white/colour	90	length + valves*	59	82.7	282.17	43.5	148.42	1.26	1.9	1.1
2150	1492	white/colour	90	length + valves*	59	104	354.85	54.1	184.59	1.28	2.3	1.3
2180	1792	white/colour	90	length + valves*	59	124	423.09	63.5	216.66	1.31	2.7	1.5
2200	1992	white/colour	90	length + valves*	59	138	470.86	70.7	241.23	1.31	3.0	1.7
3 column												
3019	185	white/colour	128	length + valves*	78	20.1	68.58	10.5	35.83	1.27	0.5	0.4
3030	300	white/colour	128	length + valves*	78	32	109.18	16.9	57.66	1.25	0.7	0.6
3035	350	white/colour	128	length + valves*	78	37	126.24	19.5	66.53	1.25	0.9	0.6
3040	400	white/colour	128	length + valves*	78	41.9	142.96	22.1	75.41	1.25	1.0	0.7
3045	450	white/colour	128	length + valves*	78	46.8	159.68	24.7	84.28	1.25	1.1	0.7
3050	500	white/colour	128	length + valves*	78	51.6	176.06	27.2	92.81	1.25	1.2	0.8
3055	550	white/colour	128	length + valves*	78	56.3	192.10	29.6	101.00	1.26	1.3	0.9
3060	600	white/colour	128	length + valves*	78	60.9	207.79	32	109.18	1.26	1.4	0.9
3075	750	white/colour	128	length + valves*	78	74.3	253.51	39	133.07	1.26	1.7	1.1
3090	900	white/colour	128	length + valves*	78	87	296.84	45.5	155.25	1.27	2.1	1.3
3100	1000	white/colour	128	length + valves*	78	95.1	324.48	49.7	169.58	1.27	2.3	1.4
3120	1200	white/colour	128	length + valves*	78	115	392.38	59.5	203.01	1.29	2.8	1.6
3150	1500	white/colour	128	length + valves*	78	140	477.68	71.7	244.64	1.31	3.4	2.0
3180	1800	white/colour	128	length + valves*	78	166	566.39	84.1	286.95	1.33	4.1	2.4
3200	2000	white/colour	128	length + valves*	78	183	624.40	92.8	316.63	1.33	4.5	2.6
4 column												
4019	200	white/colour	164	length + valves*	96	28.4	96.90	14.9	50.84	1.26	0.8	0.6
4030	300	white/colour	164	length + valves*	96	41.9	142.96	22.1	75.41	1.25	1.0	0.7
4035	350	white/colour	164	length + valves*	96	48.5	165.48	25.6	87.35	1.25	1.2	0.8
4040	400	white/colour	164	length + valves*	96	54.9	187.32	28.8	98.27	1.26	1.4	0.9
4045	450	white/colour	164	length + valves*	96	61.3	209.16	32.2	109.87	1.26	1.5	1.0
4050	500	white/colour	164	length + valves*	96	67.6	230.65	35.5	121.13	1.26	1.7	1.0
4055	550	white/colour	164	length + valves*	96	73.7	251.46	38.7	132.04	1.26	1.9	1.1
4060	600	white/colour	164	length + valves*	96	79.8	272.28	41.7	142.28	1.27	2.0	1.2
4075	750	white/colour	164	length + valves*	96	97.4	332.33	50.9	173.67	1.27	2.5	1.4
4090	900	white/colour	164	length + valves*	96	114	388.97	59.3	202.33	1.28	2.9	1.7
4100	1000	white/colour	164	length + valves*	96	125	426.50	64.7	220.76	1.29	3.2	1.8
4120	1200	white/colour	164	length + valves*	96	147	501.56	75.7	258.29	1.30	3.7	2.1
4150	1500	white/colour	164	length + valves*	96	180	614.16	92.2	314.59	1.31	4.4	2.6
4180	1800	white/colour	164	length + valves*	96	213	726.76	108	368.50	1.33	5.2	3.1
4200	2000	white/colour	164	length + valves*	96	234	798.41	119.2	406.71	1.32	5.8	3.4
5 column												
5019	200	white/colour	202	length + valves*	115	35	119.42	18.5	63.12	1.25	0.9	0.7
5030	300	white/colour	202	length + valves*	115	51.7	176.40	27.3	93.15	1.25	1.3	0.9
5040	400	white/colour	202	length + valves*	115	67.9	231.67	35.7	121.81	1.26	1.7	1.1
5045	450	white/colour	202	length + valves*	115	75.8	258.63	39.8	135.80	1.26	1.9	1.2
5050	500	white/colour	202	length + valves*	115	83.5	284.90	43.6	148.76	1.27	2.1	1.3
5055	550	white/colour	202	length + valves*	115	91.1	310.83	47.6	162.41	1.27	2.3	1.4
5060	600	white/colour	202	length + valves*	115	98.6	336.42	51.5	175.72	1.27	2.5	1.5
5075	750	white/colour	202	length + valves*	115	120	409.44	62.1	211.89	1.29	3.1	1.8
5090	900	white/colour	202	length + valves*	115	141	481.09	72.6	247.71	1.30	3.6	2.1
5100	1000	white/colour	202	length + valves*	115	154	525.45	79.3	270.57	1.30	3.9	2.3
5120	1200	white/colour	202	length + valves*	115	179	610.75	91.7	312.88	1.31	4.6	2.7
5150	1500	white/colour	202	length + valves*	115	219	747.23	111.6	380.78	1.32	5.6	3.3
6 column												
6019	200	white/colour	238	length + valves*	115	41.5	141.60	21.7	74.04	1.27	1.1	0.8
6030	300	white/colour	238	length + valves*	115	61.3	209.16	32.2	109.87	1.26	1.6	1.1
6035	350	white/colour	238	length + valves*	115	71	242.25	37.3	127.27	1.26	1.8	1.2
6040	400	white/colour	238	length + valves*	115	80.5	274.67	42.1	143.65	1.27	2.0	1.3
6045	450	white/colour	238	length + valves*	115	89.8	306.40	46.9	160.02	1.27	2.2	1.4
6050	500	white/colour	238	length + valves*	115	99	337.79	51.5	175.72	1.28	2.4	1.5
6055	550	white/colour	238	length + valves*	115	108	368.50	56.2	191.75	1.28	2.7	1.6
6060	600	white/colour	238	length + valves*	115	117	399.20	60.5	206.43	1.29	2.9	1.8
6075	750	white/colour	238	length + valves*	115	143	487.92	73.6	251.12	1.30	3.5	2.1
6090	900	white/colour	238	length + valves*	115	167	569.80	85.5	291.73	1.31	4.2	2.5
6100	1000	white/colour	238	length + valves*	115	183	624.40	93.7	319.70	1.31	4.6	2.7
6120	1200	white/colour	238	length + valves*	115	210	716.52	107	365.08	1.32	5.5	3.2
6150	1500	white/colour	238	length + valves*	115	256	873.47	130.4	444.92	1.32	6.8	4.0

*Nominal overall radiator length = (Number of sections x 46mm) + 30mm. Manufacturing tolerance of +/- 0.6mm per section

Vertical entry = overall length minus 72mm

Max. Working Pressure: 4 bar Test House: WSP-LAB
 Max. Working Temperature: 110°C Test House No: 1428

Zehnder Charleston Mirror

Stock Models													
Model code	Height mm	Width mm	Finish	Overall Projection mm	Pipe Centres mm		Outputs $\Delta T=50K$		Outputs $\Delta T=30K$		n Exponent	Weight kg	Water Content litres
					radiator	from wall	Watts	Btu	Watts	Btu			
CM2180-12	1792	552	white	126	50	74	1401	4780	762	2600	1.31	33.6	18
CM2180-16	1792	736	white	126	50	74	1792	6114	1016	3467	1.31	44.8	24

*Nominal overall radiator length = (Number of sections x 46mm) + 30mm. Manufacturing tolerance of +/- 0.6mm per section

Max. Working Pressure: 10 bar Test House: WSP-LAB
 Max. Working Temperature: 110°C Test House No: 1428

Zehnder Charleston Relax

Stock Models													
Model code	Height mm	Width mm	Finish	Overall Projection mm	Pipe Centres mm		Outputs $\Delta T=50K$		Outputs $\Delta T=30K$		n Exponent	Weight kg	Water Content litres
					radiator	from wall	Watts	Btu	Watts	Btu			
CR5026-13	455	800	white	320	50	195	543	1852	287	979	1.25	18.6	10.4
CR5026-18	455	1000	white	320	50	195	747	2549	395	1348	1.25	25.1	14.4

Max. Working Pressure: 10 bar Test House: WSP-LAB
 Max. Working Temperature: 110°C Test House No: 1428

Zehnder Metropolitan

Stock Models													
Model code	Height mm	Width mm	Finish	Overall Projection mm	Pipe Centres mm		Outputs $\Delta T=50K$		Outputs $\Delta T=30K$		n Exponent	Weight kg	Water Content litres
					radiator	from wall	Watts	Btu	Watts	Btu			
Zehnder Metropolitan horizontal													
MEH-030-140	280	1400	white/colour	79 to 89	50 or 1320	60 to 70	376	1283	198	676	1.26	8.31	4.50
MEH-040-140	385	1400	white/colour	79 to 89	50 or 1320	60 to 70	474	1617	243	829	1.31	10.30	5.29
MEH-040-160	385	1600	white/colour	79 to 89	50 or 1520	60 to 70	542	1849	278	949	1.31	11.70	5.96
MEH-050-140	490	1400	white/colour	79 to 89	50 or 1320	60 to 70	585	1996	300	1024	1.31	12.80	5.99
MEH-050-160	490	1600	white/colour	79 to 89	50 or 1520	60 to 70	669	2283	343	1170	1.31	14.60	6.73
MEH-050-180	490	1800	white/colour	79 to 89	50 or 1720	60 to 70	753	2569	386	1317	1.31	16.30	7.47
MEH-060-090	595	900	white/colour	79 to 89	50 or 820	60 to 70	447	1525	230	785	1.30	10.10	4.67
MEH-060-140	595	1400	white/colour	79 to 89	50 or 1320	60 to 70	695	2371	358	1221	1.30	15.30	6.69
MEH-060-160	595	1600	white/colour	79 to 89	50 or 1520	60 to 70	794	2709	409	1396	1.30	17.40	7.49
MEH-060-180	595	1800	white/colour	79 to 89	50 or 1720	60 to 70	894	3050	460	1570	1.30	19.50	8.30
MEH-060-200	595	2000	white/colour	79 to 89	50 or 1920	60 to 70	993	3388	511	1744	1.30	21.60	9.10
MEH-080-050	805	500	white/colour	79 to 89	50 or 420	60 to 70	387	1320	200	682	1.29	8.20	3.96
MEH-080-060	805	600	white/colour	79 to 89	50 or 520	60 to 70	449	1532	232	792	1.29	9.70	4.41
MEH-120-040	1225	400	white/colour	79 to 89	50 or 320	60 to 70	469	1600	244	833	1.28	10.30	4.90
MEH-120-050	1225	500	white/colour	79 to 89	50 or 420	60 to 70	563	1921	293	1000	1.28	12.40	5.50
MEH-120-060	1225	600	white/colour	79 to 89	50 or 520	60 to 70	653	2228	340	1160	1.28	14.50	6.10
MEH-150-040	1540	400	white/colour	79 to 89	50 or 320	60 to 70	582	1986	312	1065	1.22	12.00	5.51
MEH-150-050	1540	500	white/colour	79 to 89	50 or 420	60 to 70	730	2491	389	1327	1.23	14.40	6.25
MEH-150-060	1540	600	white/colour	79 to 89	50 or 520	60 to 70	871	2972	465	1587	1.23	16.80	6.98
MEH-180-040	1750	400	white/colour	79 to 89	50 or 320	60 to 70	663	2262	343	1170	1.29	14.40	6.73
MEH-180-050	1750	500	white/colour	79 to 89	50 or 420	60 to 70	795	2713	411	1402	1.29	17.40	7.63
Zehnder Metropolitan vertical													
MEV-180-030	1800	280	white/colour	79 to 89	50 or 200	60 to 70	206	703	108	368	1.27	11.30	5.8
MEV-180-040	1800	385	white/colour	79 to 89	50 or 305	60 to 70	412	1406	215	734	1.27	14.60	6.64
MEV-180-050	1800	490	white/colour	79 to 89	50 or 410	60 to 70	618	2109	323	1102	1.27	17.90	7.47
MEV-180-060	1800	595	white/colour	79 to 89	50 or 515	60 to 70	934	3187	478	1632	1.26	21.3	8.3
MEV-200-040	2000	385	white/colour	79 to 89	50 or 305	60 to 70	455	1552	239	815	1.26	16.10	7.31
MEV-200-050	2000	490	white/colour	79 to 89	50 or 410	60 to 70	682	2327	358	1221	1.26	19.80	8.21
MEV-200-060	2000	595	white/colour	79 to 89	50 or 515	60 to 70	910	3105	478	1631	1.26	23.50	9.1

Max. Working Pressure: 4 bar Test House: HLK STUTTGART
 Max. Working Temperature: 120°C Test House No: 0626

Zehnder Roda

Stock Models													
Model code	Height mm	Width mm	Finish	Overall Projection mm	Pipe Centres mm		Outputs $\Delta T=50K$		Outputs $\Delta T=30K$		n Exponent	Weight kg	Water Content litres
					radiator	from wall	Watts	Btu	Watts	Btu			
Zehnder Roda vertical single panel													
ROV-180-029	1800	296	white/colour	70	247	42	568	1940	291	993	1.31	12	4.6
ROV-180-037	1800	370	white/colour	70	321	42	710	2425	364	1242	1.31	15	5.75
ROV-180-044	1800	444	white/colour	70	395	42	852	2910	436	1488	1.31	18	6.9
ROV-180-051	1800	518	white/colour	70	469	42	994	3395	509	1737	1.31	21	8.05
ROV-180-059	1800	592	white/colour	70	543	42	1136	3880	582	1986	1.31	24	9.2
ROV-180-066	1800	666	white/colour	70	617	42	1278	4365	654	2231	1.31	27	10.35
Zehnder Roda vertical double panel													
ROVD-180-029	1800	296	white/colour	93	247	66	824	2812	420	1433	1.32	22.4	8.6
ROVD-180-037	1800	370	white/colour	93	321	66	1030	3515	525	1791	1.32	28	10.75
ROVD-180-044	1800	444	white/colour	93	395	66	1236	4218	630	2150	1.32	33.6	12.9
ROVD-180-051	1800	518	white/colour	93	469	66	1442	4921	735	2508	1.32	39.2	15.05
ROVD-180-059	1800	592	white/colour	93	543	66	1648	5624	840	2866	1.32	44.8	17.2
ROVD-180-066	1800	666	white/colour	93	617	66	1854	6327	945	3224	1.32	50.4	19.35
Zehnder Roda horizontal single panel													
ROH-044-140	444	1400	white/colour	70	1332	42	708	2416	368	1256	1.28	16.4	5.88
ROH-051-100	518	1000	white/colour	70	932	42	586	1999	305	1041	1.28	13.4	4.9
ROH-051-120	518	1200	white/colour	70	1132	42	703	2399	366	1249	1.28	16.1	5.88
ROH-059-100	592	1000	white/colour	70	932	42	665	2269	346	1181	1.28	14.1	5.6
ROH-059-120	592	1200	white/colour	70	1132	42	798	2723	415	1416	1.28	18.1	6.72
ROH-059-140	592	1400	white/colour	70	1332	42	931	3177	484	1651	1.28	19.7	7.84
Zehnder Roda horizontal single panel with single convactor fin													
ROHL-059-060	592	600	white/colour	92	532	62	636	2170	334	1140	1.26	13.2	3.36
ROHL-059-080	592	800	white/colour	92	732	62	848	2894	446	1522	1.26	17.6	4.48
ROHL-059-100	592	1000	white/colour	92	932	62	1060	3617	557	1900	1.26	22	5.6
ROHL-059-120	592	1200	white/colour	92	1132	62	1272	4340	668	2279	1.26	26.4	6.72
Zehnder Roda horizontal double panel													
ROHD-059-060	592	600	white/colour	93	532	66	641	2187	337	1150	1.26	16.5	6.04
ROHD-059-080	592	800	white/colour	93	732	66	855	2916	449	1532	1.26	22	8.05
ROHD-059-100	592	1000	white/colour	93	932	66	1069	3645	562	1918	1.26	27.4	10.06
ROHD-059-120	592	1200	white/colour	93	1132	66	1283	4374	674	2300	1.26	32.9	12.07
Max. Working Pressure: 4 bar				Test House: CETIAT									
Max. Working Temperature: 110°C				Test House No: 1623									

Zehnder Roda

Made to Measure Options													
Model code	Height mm	Finish	Overall Projection mm	Pipe Centres mm		Outputs $\Delta T=50K$		Outputs $\Delta T=30K$		n Exponent	Weight kg	Water Content litres	
				radiator	from wall	Watts	Btu	Watts	Btu				
Zehnder Roda ROV single, data per vertical tube													
ROV 060	600	white/colour	70	42	length minus 49	52	177	26	89	1.30	1.3	0.5	
ROV 080	800	white/colour	70	42	length minus 49	68	232	34	116	1.55	1.6	0.6	
ROV 100	1000	white/colour	70	42	length minus 49	83	283	42	143	1.32	1.9	0.7	
ROV 120	1200	white/colour	70	42	length minus 49	98	334	50	171	1.32	2.1	0.8	
ROV 140	1400	white/colour	70	42	length minus 49	113	386	58	198	1.31	2.4	0.9	
ROV 160	1600	white/colour	70	42	length minus 49	127	433	65	222	1.31	2.7	1.0	
ROV 180	1800	white/colour	70	42	length minus 49	142	485	73	249	1.31	3.0	1.2	
ROV 200	2000	white/colour	70	42	length minus 49	155	529	80	273	1.31	3.3	1.3	
ROV 220	2200	white/colour	70	42	length minus 49	169	577	87	297	1.31	3.6	1.4	
Zehnder Roda ROVD double, data per vertical tube													
ROVD 060	600	white/colour	93	66	length minus 49	77	263	39	133	1.33	2.1	0.8	
ROVD 080	800	white/colour	93	66	length minus 49	100	341	51	174	1.33	2.7	1.0	
ROVD 100	1000	white/colour	93	66	length minus 49	122	416	62	212	1.33	3.3	1.3	
ROVD 120	1200	white/colour	93	66	length minus 49	144	491	73	249	1.33	3.9	1.5	
ROVD 140	1400	white/colour	93	66	length minus 49	165	563	84	287	1.33	4.4	1.7	
ROVD 160	1600	white/colour	93	66	length minus 49	186	635	95	324	1.32	5.0	1.9	
ROVD 180	1800	white/colour	93	66	length minus 49	206	703	105	358	1.32	5.6	2.2	
ROVD 200	2000	white/colour	93	66	length minus 49	225	768	115	392	1.32	6.2	2.4	
ROVD 220	2200	white/colour	93	66	length minus 49	244	833	124	423	1.32	6.7	2.6	
To calculate the number of tubes required, allow 74mm per tube													
Max. Working Pressure: 4 bar				Test House: CETIAT									
Max. Working Temperature: 110°C				Test House No: 1623									

Zehnder Roda

Made to Measure Options													
Model code	Height mm	Finish	Overall Projection mm	Pipe Centres mm		Outputs $\Delta T=50K$		Outputs $\Delta T=30K$		n Exponent	Weight kg	Water Content litres	
				radiator	from wall	Watts	Btu	Watts	Btu				
Zehnder Roda ROH single, data per linear metre													
ROH 4 tubes	296	white/colour	70	42	length minus 68		344	1174	179	611	1.28	7.2	2,80
ROH 5 tubes	370	white/colour	70	42	length minus 68		425	1450	221	754	1.28	9.0	3,50
ROH 6 tubes	444	white/colour	70	42	length minus 68		506	1726	264	901	1.28	10.7	4,20
ROH 7 tubes	518	white/colour	70	42	length minus 68		586	1999	305	1041	1.28	12.4	4,90
ROH 8 tubes	592	white/colour	70	42	length minus 68		665	2269	347	1184	1.28	14.1	5,60
Zehnder Roda ROHL single with convector fins, data per linear metre													
ROHL 2 tubes	148	white/colour	92	62	length minus 68		350	1194	195	665	1.15	7.0	1,40
ROHL 3 tubes	222	white/colour	92	62	length minus 68		511	1744	268	914	1.26	10.7	2,10
ROHL 4 tubes	296	white/colour	92	62	length minus 68		637	2173	334	1140	1.27	14.3	2,80
ROHL 5 tubes	370	white/colour	92	62	length minus 68		719	2453	374	1276	1.28	16.1	3,50
ROHL 6 tubes	444	white/colour	92	62	length minus 68		845	2883	448	1529	1,24	18.7	4,20
ROHL 7 tubes	518	white/colour	92	62	length minus 68		927	3163	492	1679	1,24	19.5	4,90
ROHL 8 tubes	592	white/colour	92	62	length minus 68		1060	3617	558	1904	1.26	23.6	5,60
Max. Working Pressure: 4 bar			Test House: CETIAT										
Max. Working Temperature: 110°C			Test House No: 1623										

Zehnder Roda Mirror

Stock Models													
Model code	Height mm	Width mm	Finish	Overall Projection mm	Pipe Centres mm		Outputs $\Delta T=50K$		Outputs $\Delta T=30K$		n Exponent	Weight kg	Water Content litres
					radiator	from wall	Watts	Btu	Watts	Btu			
ROM-180-067	1800	666	white/colour	70	617	42	680	2320	348	1187	1.31	24.6	6.3
ROM-180-081	1800	814	white/colour	70	765	42	952	3248	488	1665	1.31	31.0	8.6
ROMD-180-067	1800	666	white/colour	93	617	66	1355	4623	690	2354	1.32	51.6	15.4
ROMD-180-081	1800	814	white/colour	93	765	66	1527	5210	778	2655	1.32	64.0	19.7
Max. Working Pressure: 4 bar			Test House: CETIAT										
Max. Working Temperature: 110°C			Test House No: 1623										

Zehnder Ax

Stock Models													
Model code	Height mm	Width mm	Finish	Overall Projection mm	Pipe Centres mm		Outputs $\Delta T=50K$		Outputs $\Delta T=30K$		n Exponent	Weight kg	Water Content litres
					radiator	from wall	Watts	Btu	Watts	Btu			
Zehnder Ax vertical single panel													
ZAV-180-035	1800	352	white/colour	76	303	49	704	2196	361	1230	1.31	12.9	2.08
ZAV-180-044	1800	440	white/colour	76	391	49	880	3003	451	1538	1.31	16.1	2.60
ZAV-180-053	1800	528	white/colour	76	479	49	1056	4468	541	1845	1.31	19.3	3.12
ZAV-180-061	1800	616	white/colour	76	567	49	1232	4204	631	2153	1.31	22.5	3.64
Zehnder Ax horizontal double panel													
ZAHD-061-080	616	800	white/colour	87	750	61	884	3016	455	1552	1.3	20.2	3.35
ZAHD-061-100	616	1000	white/colour	87	950	61	1105	3770	569	1941	1.3	24.8	4.19
ZAHD-061-120	616	1200	white/colour	87	1150	61	1326	4524	683	2330	1.3	29.4	5.03
ZAHD-061-140	616	1400	white/colour	87	1350	61	1547	5278	796	2716	1.3	35.4	5.87
Max. Working Pressure: 4 bar			Test House: CETIAT										
Max. Working Temperature: 110°C			Test House No: 1623										

Zehnder Ax

Made to Measure Options												
Model code	Height mm	Finish	Overall Projection mm	Pipe Centres mm		Outputs $\Delta T=50K$		Outputs $\Delta T=30K$		n Exponent	Weight kg	Water Content litres
				radiator	from wall	Watts	Btu	Watts	Btu			
Zehnder Ax ZA single, data per vertical tube												
ZA-060	600	white/colour	49	76	length minus 49mm	33.0	112.6	17.0	58.0	1.28	0.6	0.14
ZA-080	800	white/colour	49	76	length minus 49mm	42.0	143.3	22.0	75.1	1.29	0.8	0.16
ZA-100	1000	white/colour	49	76	length minus 49mm	51.0	174.0	27.0	92.1	1.29	1.0	0.96
ZA-120	1200	white/colour	49	76	length minus 49mm	60.0	204.7	31.0	105.8	1.30	1.1	1.12
ZA-140	1400	white/colour	49	76	length minus 49mm	70.0	238.8	36.0	122.8	1.30	1.3	1.29
ZA-160	1600	white/colour	49	76	length minus 49mm	79.0	269.5	40.0	136.5	1.31	1.5	1.45
ZA-180	1800	white/colour	49	76	length minus 49mm	88.0	300.3	45.0	153.5	1.31	1.2	1.61
ZA-200	2000	white/colour	49	76	length minus 49mm	98.0	334.4	50.0	170.6	1.32	1.8	1.78
ZA-220	2200	white/colour	49	76	length minus 49mm	107.0	365.1	55.0	187.7	1.32	2.0	1.94
Zehnder Ax ZAD double, data per vertical tube												
ZAD-060	600	white/colour	61	87	length minus 49mm	51.0	174.0	26.0	88.7	1.30	1.1	1.12
ZAD-080	800	white/colour	61	87	length minus 49mm	66.0	225.2	34.0	116.0	1.30	1.5	1.45
ZAD-100	1000	white/colour	61	87	length minus 49mm	80.0	273.0	41.0	139.9	1.30	1.8	1.78
ZAD-120	1200	white/colour	61	87	length minus 49mm	94.0	320.7	48.0	163.8	1.31	2.1	2.11
ZAD-140	1400	white/colour	61	87	length minus 49mm	108.0	368.5	55.0	187.7	1.31	2.4	2.43
ZAD-160	1600	white/colour	61	87	length minus 49mm	122.0	416.3	62.0	211.5	1.31	2.8	2.76
ZAD-180	1800	white/colour	61	87	length minus 49mm	136.0	464.0	70.0	238.8	1.31	3.1	3.09
ZAD-200	2000	white/colour	61	87	length minus 49mm	150.0	511.8	77.0	262.7	1.32	3.4	3.42
ZAD-220	2200	white/colour	61	87	length minus 49mm	164.0	559.6	84.0	286.6	1.317	3.8	3.75

To calculate the number of tubes required, allow 44mm per tube

Max. Working Pressure: 4 bar Test House: CETIAT
 Max. Working Temperature: 110°C Test House No: 1623

Made to Measure Options												
Model code	Height mm	Finish	Overall Projection mm	Pipe Centres mm		Outputs $\Delta T=50K$		Outputs $\Delta T=30K$		n Exponent	Weight kg	Water Content litres
				radiator	from wall	Watts	Btu	Watts	Btu			
Zehnder Ax ZAH single, data per linear metre												
ZAH 6	264	white/colour	49	76	length minus 50mm	308	1051	157	536	1.32	6.10	1.22
ZAH 8	352	white/colour	49	76	length minus 50mm	414	1413	211	720	1.32	8.00	1.62
ZAH 10	440	white/colour	49	76	length minus 50mm	520	1774	266	908	1.31	10.00	2.03
ZAH 12	528	white/colour	49	76	length minus 50mm	625	2133	320	1092	1.31	11.90	2.44
ZAH 14	616	white/colour	49	76	length minus 50mm	730	2491	374	1276	1.31	13.80	2.84
Zehnder Ax ZAH double, data per linear metre												
ZAHD 6	264	white/colour	61	87	length minus 50mm	529	1805	273	931	1.30	11.00	1.79
ZAHD 8	352	white/colour	61	87	length minus 50mm	680	2320	350	1194	1.30	14.60	2.39
ZAHD 10	440	white/colour	61	87	length minus 50mm	825	2815	425	1450	1.30	18.10	2.99
ZAHD 12	528	white/colour	61	87	length minus 50mm	966	3296	498	1699	1.30	21.70	3.59
ZAHD 14	616	white/colour	61	87	length minus 50mm	1105	3770	570	1945	1.30	25.30	4.19

Max. Working Pressure: 4 bar Test House: CETIAT
 Max. Working Temperature: 110°C Test House No: 1623

Zehnder Kleo

Stock Models													
Model code	Height mm	Width mm	Finish	Overall Projection mm	Pipe Centres mm		Outputs $\Delta T=50K$		Outputs $\Delta T=30K$		n Exponent	Weight kg	Water Content litres
					radiator	from wall	Watts	Btu	Watts	Btu			
Vertical													
KLV-180-009	1800	299	white/colour	74	248	38	632	2156	329	1123	1.28	10.8	4.5
KLV-180-012	1800	398	white/colour	74	347	38	842	2874	438	1494	1.28	14.4	6.1
KLV-180-015	1800	497	white/colour	74	446	38	1053	3593	548	1870	1.28	18.0	7.5
KLV-180-018	1800	596	white/colour	74	545	38	1264	4313	647	2209	1.28	21.6	9.0
KLVC-180-009	1800	299	chrome	74	248	38	448	1529	225	768	1.35	10.8	4.5
KLVC-180-012	1800	398	chrome	74	347	38	598	2040	300	1024	1.35	14.4	6.1
KLVC-180-015	1800	497	chrome	74	446	38	747	2549	375	1280	1.35	18.0	7.5
KLVC-180-018	1800	596	chrome	74	545	38	896	3057	450	1535	1.35	21.6	9.0
Horizontal													
KLH-058-100	596	1000	white/colour	74	962	38	782	2668	413	1409	1.25	12.7	5.5
KLH-058-120	596	1200	white/colour	74	1162	38	938	3201	495	1689	1.25	14.9	6.6
KLH-058-140	596	1400	white/colour	74	1362	38	1095	3736	578	1972	1.25	17.1	7.7
KLHD-058-100	596	1000	white/colour	106	962	38	1211	4134	636	2170	1.26	22.6	12.5
KLHD-058-120	596	1200	white/colour	106	1162	38	1453	4961	763	2603	1.26	27.1	15.0
KLHD-058-140	596	1400	white/colour	106	1362	38	1695	5787	891	3040	1.26	31.6	17.5
Max. Working Pressure: 4 bar				Test House: CETIAT									
Max. Working Temperature: 110°C				Test House No: 1623									

Zehnder Kleo

Made to Measure Options													
Model code	Height mm	Finish	Overall Projection mm	Pipe Centres mm		Outputs $\Delta T=50K$		Outputs $\Delta T=30K$		n Exponent	Weight kg	Water Content litres	
				radiator	from wall	Watts	Btu	Watts	Btu				
Zehnder Kleo KLV single, data per vertical tube													
KLV 060	600	white/colour	74	49	length minus 38	26.0	88.7	14.0	47.8	1.27	0.5	0.2	
KLV 080	800	white/colour	74	49	length minus 38	34.0	116.0	18.0	61.4	1.27	0.6	0.3	
KLV 100	1000	white/colour	74	49	length minus 38	41.0	139.9	21.0	71.7	1.27	0.7	0.3	
KLV 120	1200	white/colour	74	49	length minus 38	49.0	167.2	25.0	85.3	1.27	0.8	0.4	
KLV 140	1400	white/colour	74	49	length minus 38	56.0	191.1	29.0	98.9	1.28	0.9	0.4	
KLV 160	1600	white/colour	74	49	length minus 38	63.0	215.0	33.0	112.6	1.28	1.0	0.5	
KLV 180	1800	white/colour	74	49	length minus 38	70.0	238.8	37.0	126.2	1.28	1.2	0.5	
KLV 200	2000	white/colour	74	49	length minus 38	78.0	266.1	40.0	136.5	1.28	1.3	0.5	
KLV 220	2200	white/colour	74	49	length minus 38	85.0	290.0	44.0	150.1	1.28	1.4	0.6	
To calculate the number of tubes required, allow 44mm per tube													
Max. Working Pressure: 4 bar				Test House: CETIAT									
Max. Working Temperature: 110°C				Test House No: 1623									

Made to Measure Options													
Model code	Height mm	Finish	Overall Projection mm	Pipe Centres mm		Outputs $\Delta T=50K$		Outputs $\Delta T=30K$		n Exponent	Weight kg	Water Content litres	
				radiator	from wall	Watts	Btu	Watts	Btu				
Zehnder Kleo KLH single, data per linear metre													
KLH 12 tubes	398	white/colour	74	49	length minus 38	515	1757	278	949	1.21	8.5	3.7	
KLH 14 tubes	464	white/colour	74	49	length minus 38	611	2085	322	1099	1.26	9.9	4.3	
KLH 16 tubes	530	white/colour	74	49	length minus 38	697	2378	367	1252	1.26	11.3	4.9	
KLH 18 tubes	596	white/colour	74	49	length minus 38	782	2668	412	1406	1.25	12.7	5.5	
KLH 20 tubes	662	white/colour	74	49	length minus 38	867	2958	457	1559	1.25	14.1	6.1	
KLH 22 tubes	728	white/colour	74	49	length minus 38	951	3245	502	1713	1.25	15.5	6.7	
KLH 24 tubes	794	white/colour	74	49	length minus 38	1034	3528	545	1860	1.25	16.9	7.3	
KLH 26 tubes	860	white/colour	74	49	length minus 38	1117	3811	590	2013	1.25	18.3	7.9	
KLH 28 tubes	926	white/colour	74	49	length minus 38	1200	4094	634	2163	1.25	19.7	8.5	
KLH 30 tubes	992	white/colour	74	49	length minus 38	1282	4374	677	2310	1.25	21.1	9.1	
KLH 32 tubes	1058	white/colour	74	49	length minus 38	1364	4654	721	2460	1.25	22.5	9.8	
KLH 34 tubes	1124	white/colour	74	49	length minus 38	1445	4930	764	2607	1.25	23.9	10.4	
KLH 36 tubes	1190	white/colour	74	49	length minus 38	1526	5207	807	2753	1.247	25.3	11.0	
Max. Working Pressure: 4 bar				Test House: CETIAT									
Max. Working Temperature: 110°C				Test House No: 1623									

Zehnder Stratos

Stock Models													
Model code	Height mm	Width mm	Finish	Overall Projection mm	Pipe Centres mm		Outputs $\Delta T=50K$		Outputs $\Delta T=30K$		n Exponent	Weight kg	Water Content litres
					radiator	from wall	Watts	Btu	Watts	Btu			
With factory-fitted grille, standard white (RAL 9010)													
CSG-15-10-1000	153	1000	white/colour	98	1000*	79	755	2578	379	1293	1.35	12.3	3.0
CSG-15-10-1200	153	1200	white/colour	98	1200*	79	906	3092	455	1551	1.35	14.8	3.6
CSG-15-10-1400	153	1400	white/colour	98	1400*	79	1057	3607	530	1810	1.35	17.2	4.2
CSG-15-10-1500	153	1500	white/colour	98	1500*	79	1134	3868	569	1941	1.35	18.5	4.5
CSG-15-10-1600	153	1600	white/colour	98	1600*	79	1209	4125	607	2070	1.35	19.7	4.8
CSG-15-10-2000	153	2000	white/colour	98	2000*	79	1511	5155	758	2587	1.35	24.6	6.0
CSG-15-19-1000	153	1000	white/colour	186	1000*	167 flow, 79 return	1331	4542	671	2290	1.34	21.3	4.8
CSG-15-19-1200	153	1200	white/colour	186	1200*	167 flow, 79 return	1598	5451	806	2750	1.34	25.6	5.8
CSG-15-19-1400	153	1400	white/colour	186	1400*	167 flow, 79 return	1864	6360	940	3208	1.34	29.8	6.7
CSG-15-19-1500	153	1500	white/colour	186	1500*	167 flow, 79 return	1997	6813	1007	3436	1.34	32.0	7.2
CSG-15-19-1600	153	1600	white/colour	186	1600*	167 flow, 79 return	2130	7266	1074	3665	1.34	34.1	7.7
CSG-15-19-2000	153	2000	white/colour	186	2000*	167 flow, 79 return	2663	9085	1343	4583	1.34	42.6	9.6

*plus valves
 Max. Working Pressure: 4.5 bar Test House: CETIAT
 Max. Working Temperature: 120°C Test House No: 0626

Zehnder Lyta-S Horizontal

Stock Models													
Model code	Height mm	Width mm	Finish	Overall Projection mm	Pipe Centres mm		Outputs $\Delta T=50K$		Outputs $\Delta T=30K$		n Exponent	Weight kg	Water Content litres
					radiator	from wall	Watts	Btu	Watts	Btu			
LYSV-041-048	407	480	white*	130	504 plus valves	82	560	1911	289	986	1.30	6.6	0.24
LYSV-041-064	407	640	white*	130	664 plus valves	82	747	2549	385	1314	1.30	8.8	0.24
LYSV-041-080	407	800	white*	130	824 plus valves	82	934	3187	481	1641	1.30	11.0	0.24
LYSV-041-096	407	960	white*	130	984 plus valves	82	1121	3825	577	1969	1.30	13.2	0.24
LYSV-041-112	407	1120	white*	130	1144 plus valves	82	1308	4463	673	2296	1.30	15.4	0.24
LYSV-056-048	557	480	white*	130	504 plus valves	82	746	2545	381	1300	1.32	8.4	0.30
LYSV-056-064	557	640	white*	130	664 plus valves	82	995	3395	508	1733	1.32	11.2	0.30
LYSV-056-080	557	800	white*	130	824 plus valves	82	1234	4210	635	2167	1.32	14.0	0.30
LYSV-056-096	557	960	white*	130	984 plus valves	82	1492	5091	762	2600	1.32	16.8	0.30
LYSV-056-112	557	1120	white*	130	1144 plus valves	82	1740	5937	889	3033	1.32	19.6	0.30
LYSV-066-048	657	480	white*	130	504 plus valves	82	855	2917	434	1481	1.33	9.6	0.35
LYSV-066-064	657	640	white*	130	664 plus valves	82	1140	3890	578	1972	1.33	12.8	0.35
LYSV-066-080	657	800	white*	130	824 plus valves	82	1425	4862	723	2467	1.33	16.0	0.35
LYSV-066-096	657	960	white*	130	984 plus valves	82	1710	5835	868	2962	1.33	19.2	0.35
LYSV-066-112	657	1120	white*	130	1144 plus valves	82	1995	6807	1012	3453	1.33	22.4	0.35

*white (RAL 9010)
 Max. Working Pressure: 24 bar Test House: Laboratorio Misure Ricerche Termotecniche
 Max. Working Temperature: 120°C Test House No: 1695

Zehnder Lyta-T Vertical

Stock Models													
Model code	Height mm	Width mm	Finish	Overall Projection mm	Pipe Centres mm		Outputs $\Delta T=50K$		Outputs $\Delta T=30K$		n Exponent	Weight kg	Water Content litres
					radiator	from wall	Watts	Btu	Watts	Btu			
LYTV-097-032	966	320	white*	110 to 140	344 plus valves	82	728	2484	362	1234	1.37	7.8	1.7
LYTV-097-048	966	480	white*	110 to 140	504 plus valves	82	1092	3726	542	1851	1.37	11.8	2.6
LYTV-147-032	1466	320	white*	110 to 140	344 plus valves	82	1000	3412	499	1703	1.39	11.2	2.5
LYTV-147-048	1466	480	white*	110 to 140	504 plus valves	82	1500	5118	749	2555	1.39	16.8	3.7
LYTV-187-024	1866	240	white*	110 to 140	264 plus valves	82	900	3071	442	1510	1.39	10.2	2.3
LYTV-187-032	1866	320	white*	110 to 140	344 plus valves	82	1200	4094	590	2013	1.39	13.6	3.1
LYTV-187-040	1866	400	white*	110 to 140	424 plus valves	82	1500	5118	737	2516	1.39	17.0	3.9
LYTV-187-048	1866	480	white*	110 to 140	504 plus valves	82	1800	6142	885	3019	1.39	20.4	4.7

*white (RAL 9010)
 Max. Working Pressure: 6 bar Test House: Laboratorio Misure Ricerche Termotecniche
 Max. Working Temperature: 120°C Test House No: 1695

Colour System

Architectural

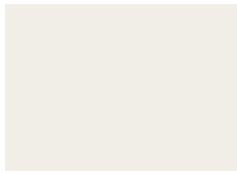

White Matt
0556

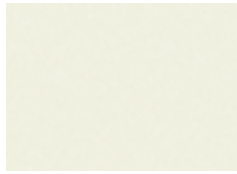

White Quartz
0521

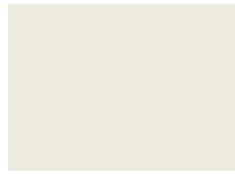

Pure White
RAL 9010 / 9010*



Inox Look
0332*



White Aluminium
9006*



Titane
0335*



Grey Aluminium
9007*



Anthracite
0346



Volcanic
0336



Anthracite Grey
RAL 7016 / 7016*

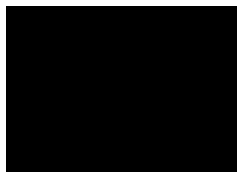

Traffic Black
RAL 9017 / 9017*



Jet Black
RAL 9005 / 9005*

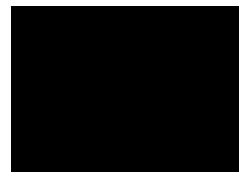

Black Matt
0557



Black Quartz
0550

Tonic

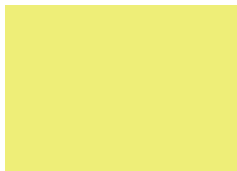

Lemon
0515*



Traffic Yellow
RAL 1023 / 1023*



Orange Quartz
0528



Flame Red
RAL 3000 / 3000*



Ruby Red
RAL 3003 / 3003*

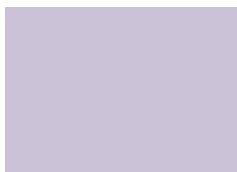

Mauve
0517*



Violet
0518*



Strawberry
NCS-S-2065-R20B / 3770



Dark Purple
0848



Amethyst Quartz
0516



Lichen
NCS-S-2010-G60Y / 8723



Spring Green
0846



Pacific Blue
0519



Horizon Blue
0520*



Prussian Blue
0555*

* These colours have a glossy finish, all others are matt.

Some colours/surface finishes are only available for selected products.

Deviations are possible (shade and shine) due to the different manufacturing techniques used for the original colours. RAL and NCS are manufacturer designations.

This colour chart only represents the range of Zehnder colours available. It is not representative of the actual colour finish. Please ask for a colour chart from which to confirm your selection before placing your order.

Natural

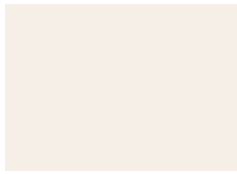

Edelweiss
0067

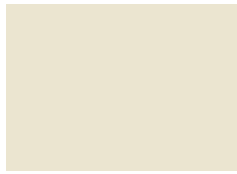

Cream
RAL 9001 / 9001*

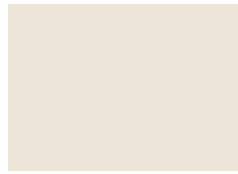

Pergamon
0081*



Jasmin
0072



Oyster White
RAL 1013 / 1013*



Grey White
RAL 9002 / 9002*

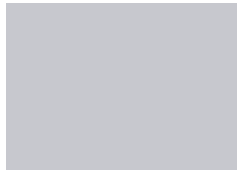

Chinchilla
0064



Manhattan
0077*



Natura
0035*



Bahama
0054*

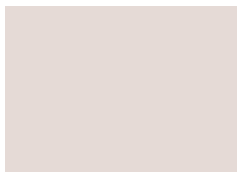

Petal
0510*

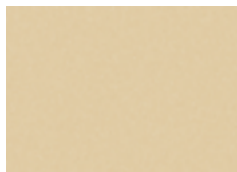

Sand Quartz
0522



Beige Quartz
0523



Caramel Quartz
0511

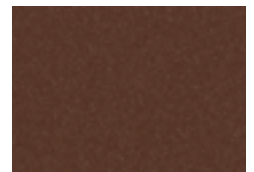

Terracotta Quartz
0512



Gold Look
0514*

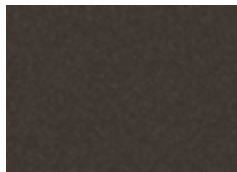

Brown Quartz
0529



Dark Brown
0847



Chocolate Brown
RAL 8017 / 8017*

Standard

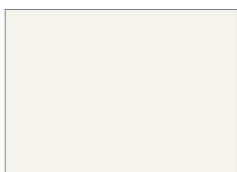

Traffic White
RAL 9016 / 9016*

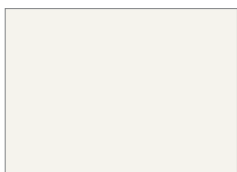

Traffic White
RAL 9016 - matt version
(incurs +25% colour surcharge)

Surfaces



Chrome
0008



Stainless Steel
Only available for stainless steel radiators



Technoline (Clear)
Bare-metal lacquer
Choice of two finishes:
0325 for glossy finish
0328 for matt finish
Only available for Charleston range



Black-silver hammered finish
0422* Only available for Charleston range



Copper-black hammered finish
0421* Only available for Charleston range

General Information

Heat Loss Calculator

This easy-to-use heat calculator can work out the heat requirements for your room.

Stage 1 Take the room dimensions in metres

Width m Length m Height m

calculate the volume ($W \times L \times H$) = cubic metres

Stage 2 Heating requirements per room type

Living Room / Dining Room / Bathroom volume

multiply volume as calculated in Stage 1 by 50 = Watts required

Bedroom volume

multiply volume as calculated in Stage 1 by 40 = Watts required

Kitchen / Hallway volume

multiply volume as calculated in Stage 1 by 30 = Watts required

Stage 3 Other factors for consideration

Is the property exposed?

a

Does the room have large areas of glazing?

b

Are the windows double glazed?

c

If factor 'a' applies, increase the Watts required at Stage 2 by 15%

If factor 'b' applies, increase the Watts required at Stage 2 by 20%

If factor 'c' applies, decrease the Watts required at Stage 2 by 10%

If factor 'a' and 'b' apply, increase the Watts required at Stage 2 by 35%

If factor 'a' and 'c' apply, increase the Watts required at Stage 2 by 10%

If factor 'b' and 'c' apply, increase the Watts required at Stage 2 by 10%

If factor 'a', 'b' and 'c' apply, increase the Watts required at Stage 2 by 25%

Please note that this calculator is provided as a guide only.

To convert Watts to BTUs, multiply by 3.412.

For an approximate conversion from $\Delta T50^{\circ}\text{C}$ to $\Delta T60^{\circ}\text{C}$, multiply the $\Delta T50^{\circ}\text{C}$ output by 1.2.

Terms and Conditions of Trading

A complete copy of the company's terms and conditions of trading are available on our website www.zehnder.co.uk

In addition to the Terms and Conditions, please note the following:

- All delivery times quoted are estimates only. Prices quoted include free delivery to the UK mainland for radiators and towel rails. Orders for valves, fans, elements and accessories with a net order value under £100 are subject to a processing charge of £10 + VAT
- Returned goods for credit will only be accepted by prior arrangement (confirmed in writing), within 8 weeks of the date of despatch, where the goods are part of our stock range and where the goods are as fit for sale on their return as they were on delivery. If goods have been fitted this is deemed as acceptance of their quality. We cannot accept the return of non-stock goods.
- You are responsible for ensuring the suitability, conformity and interoperability of the goods or indicative system design suggestions provided by us with your heating system and your design requirements. It is important that you undertake such verification with an appropriately qualified expert third party
- Where a radiator is returned as no longer required and an alternative radiator is not ordered a 25% restocking fee plus a £10 administration fee will be charged (unless the goods were defective when delivered). If a radiator is no longer required but an alternative radiator is ordered, either a restocking fee of £25 or 25% of the value (whichever is the lower) will be charged, but the administration fee will be waived.
- We warrant the goods for a period of 5 years for steel radiators, 10 years for stainless steel and aluminium radiators, 2 years for radiator electrical componentry and 3 years for extractor fans, from the date of delivery. The warranty is subject to correct installation to current standards/water treatments and use.
- Radiators with steel components (other than stainless steel) must not be installed on a domestic hot water circuit. If a stainless steel or brass product is to be installed on the domestic hot water circuit, a check should be made with the local water authority to ensure that dezincification is not a common occurrence.
- Artificially softened water should not be used to fill radiators. For FAQ radiator/water-related information, visit www.fernox.com.
- All measurements given in this brochure are nominal dimensions only.
- All brochures, catalogues and other promotional materials are to be treated as illustrative only. Their contents form no part of any contract between us and you should not rely on them in entering into any contract with us. Any typographical, clerical or other error or omission in any literature, quotation, price list, or other document issued by us will be subject to correction without liability being incurred by us.

Bathroom Zones

The diagram below shows a bathroom divided into four clear zones: 0, 1, 2 and outside zones. Please note, the diagram is only a guide and is NOT to scale. Please refer to I.E.E Wiring Regulations (BS 7671:2008) for detailed information.

Zone 0: Inside the bath

Zone 1: Area above bath / shower tray to a height of 2.25m.

Minimum rating of IPX4 should be used unless water spray will be present. In this case, a rating of IPX5 should be used.

Zone 2: Area stretching 0.6m from zone 1. Minimum rating of IPX4 should be used here.

Outside Zones: No water spray is likely to be used here, therefore, no IP rating is required.

IP Rating: "X" denotes level of security against dust particles. Second digit denotes level of "watertightness".

IPX5: Protected against low pressure water jets

IPX4: Protected against splashing water

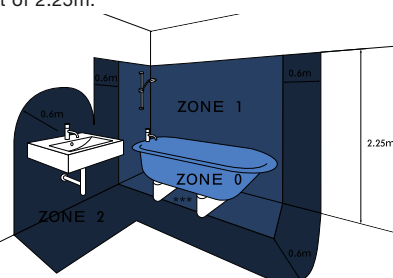

OUTSIDE ZONES

Frequently Asked Questions

Why is it important with some of the models that the flow is in a specific connection position?

Some of the design radiators have baffles inside the water-carrying tubes to divert the water flow around the whole radiator to maximize efficiency. Check the installation instructions to see if this applies to the radiator before it is installed.

What is an inhibitor and why should it be used in a central heating system?

An inhibitor is a chemical mix that should be added to the central heating system water to prevent corrosion and to prolong the life of the system. When new or additional radiators are being installed, the system should be drained, cleaned and flushed in accordance with BS7593 and a good quality chemical water treatment inhibitor should be added to the heating system.

Can steel and aluminium radiators be put on the same system?

Yes, as long as an inhibitor for mixed metal systems is used. In reality, most systems are already mixed metal, as many have aluminium heat exchangers in the boiler, plus copper pipes and steel radiators already installed.

Why is it important to use dual energy installations correctly?

Simultaneous use of the electrical element and the central heating system should be avoided as this will shorten the life of the element and invalidate the warranty. Correct use is as follows: In summer when the central heating is switched off, vent the radiator to ensure there is no air present, then close the flow valve (only) and activate the immersion heater. In winter, de-activate the immersion heater and open the flow valve.

What is the difference between outputs listed at $\Delta T60^{\circ}\text{C}$ and $\Delta T50^{\circ}\text{C}$?

$\Delta T60^{\circ}\text{C}$ allows for older boiler systems, whilst $\Delta T50^{\circ}\text{C}$ is the new European testing standard for modern boilers, such as condensing boilers, which have lower flow and return temperatures. Therefore, to avoid radiators being incorrectly sized, it is important to know the system's temperatures and take them into consideration.



Zehnder – solutions for the perfect indoor climate.

Zehnder, leading manufacturers of decorative radiators, towel rails and extractor fans, is committed to innovation, originality and offering the best in quality and service. With a portfolio of traditional and contemporary designs, including an extensive stainless steel range, bespoke made-to-measure options and hundreds of different colours to choose from, Zehnder offers a solution for all lifestyles and preferences.

Zehnder affirms that all our products are tested to the European Standard EN442 and that our published outputs are fully in line with the testing criteria. Our aim is to provide reliability and precision at every stage of the design process and to give specifiers and installers confidence in the sizing of all our radiators and heated towel rails.

Contact details:

Zehnder (retail) · Watchmoor Point · Camberley · Surrey · GU15 3AD
T: +44 (0) 1276 605800
retailsales@zehnder.co.uk · www.zehnder.co.uk

always the
best climate

zehnder

Zehnder (retail) - A Division of Zehnder Group UK Ltd
Watchmoor Point · Camberley · Surrey · GU15 3AD · Registered in England: 2296696
T: +44 (0) 1276 605800 F: +44 (0) 1276 24058
For placing an order · orders@zehnder.co.uk
For general enquiries · retailsales@zehnder.co.uk
aftersales@zehnder.co.uk
www.zehnder.co.uk

zehnder